

Price List

Valid for the first half of 2022

Switzerland



BRDR. KRÜGER

A NEW TURN ON TRADITION

Tables

Bølling Tray Table , Hans Bølling	4-11
Jari Collection , OEO Studio	12-21
Arv Collection , David Thulstrup	22-25
TRIIIO Collection , Hans Bølling	26-29

Seating

Arv Dining Chair , David Thulstrup	31-36
Arv Lounge Chair , David Thulstrup	37
Arkade Chair , Nanna Ditzel	38-42
F-Chair , Rasmus B. Fex	43-48
Pauline Bar Stool , OEO Studio	50-61
Jari Dining Chair , OEO Studio	62-63
Ferdinand Lounge Chair , OEO Studio	64-65
Karm Sofa , Studio David Thulstrup	66-69

Lighting

Lune Collection , Sverre Uhnger	71-73
---	-------

Complements

Bølling Tray , Hans Bølling	75-78
Bølling Wheel , Hans Bølling	79
Arv Cushion , David Thulstrup	80
Mokuba Rocking Horse , O&M Design	81
Orbis Table , O&M Design	82
Samples	83

General Information

Sustainability	85
Material Information	86-92
How to Order	95
General Terms & Conditions	96-100
Contact Information	101

Tables



Bølling Tray Table

by Hans Bølling







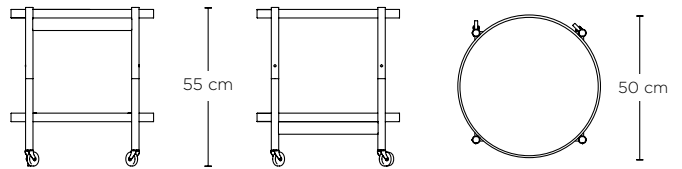

Bølling Tray Table
Hans Bølling







 BRDR. KRÜGER



Bølling Tray Table - Model 50
Hans Bølling



		Euro ex. VAT	#Reference
	Beech, Untreated	580	BBO1-BUN
	Beech, Oil	655	BBO1-BOL
	Beech, Black Lacquer	710	BBO1-BBA
	Oak, Untreated	630	BBO1-OUN
	Oak, Oiled	705	BBO1-OOL
	Oak, Black Lacquer	755	BBO1-OBA
	Fumed Oak, Oil	755	BBO1-OFU
	Walnut, Oil	755	BBO1-WOL

Tray Colour	# Reference
	BASE (Black / White) BA
	STONE (Grey / Dark Grey) ST
	EARTH (Beige / Brown) EA
	LEAF (Green / Dark Green) LE
	WATER (Blue / Dark Blue) WA
	SUNNY (Cream / Yellow) SU
	CLAY (Cognac / Black) CL
	RED (Red / Black) RE







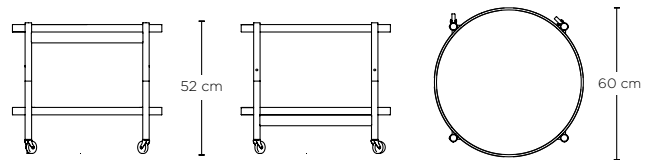

Dimensions	
Diameter	Ø50 cm
Height	55 cm
Tray Height	3 cm
Box	78 x 11 x 56 cm
Weight	5 kg



Notes:

- Shipped flat packed.
- Ready to assemble, no tools needed.
- Top and bottom trays come in the same colour combination as standard.
- Handling cost of choosing two different colour combinations is 25 EURO.

Bølling Tray Table - Model 60
Hans Bølling



		Euro ex. VAT	#Reference
	Beech, Untreated	700	BBO3-BUN
	Beech, Oil	775	BBO3-BOL
	Beech, Black Lacquer	890	BBO3-BBA
	Oak, Untreated	800	BBO3-OUN
	Oak, Oiled	875	BBO3-OOL
	Oak, Black Lacquer	990	BBO3-OBA
	Fumed Oak, Oil	990	BBO3-OFU
	Walnut, Oil	990	BBO3-WOL

Tray Colour	# Reference
	BASE (Black / White) BA
	STONE (Grey / Dark Grey) ST
	EARTH (Beige / Brown) EA
	LEAF (Green / Dark Green) LE
	WATER (Blue / Dark Blue) WA
	SUNNY (Cream / Yellow) SU
	CLAY (Cognac / Black) CL
	RED (Red / Black) RE

Dimensions	
Diameter	Ø60 cm
Height	52 cm
Tray Height	2,5 cm
Box	90 x 12 x 60 cm
Weight	6,5 kg

Notes:

- Shipped flat packed.
- Ready to assemble, no tools needed.
- Top and bottom trays come in the same colour combination as standard.
- Handling cost of choosing two different colour combinations is 25 EURO.



Bølling Veneer Tray Table

by Hans Bølling

Bølling Veneer Tray Table
Hans Bølling

 BRDR. KRÜGER



Bølling Tray Table - Veneer Model 50
Hans Bølling

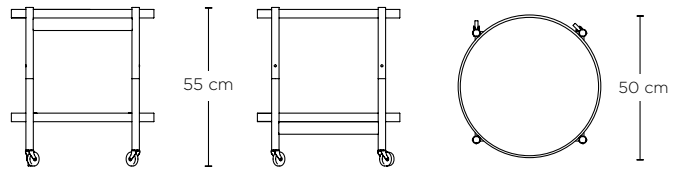

		Euro ex. VAT	#Reference
	Beech, Oil	735	BBO1-BOL-VV
	Beech, Black Lacquer	795	BBO1-BBA-VV
	Oak, Oil	780	BBO1-OOL-VV
	Oak, Black Lacquer	830	BBO1-OBA-VV
	Fumed Oak, Oil	830	BBO1-OFU-VV
	Walnut, Oil	830	BBO1-WOL-VV

Dimensions

Diameter	Ø50 cm
Height	55 cm
Tray Height	3 cm
Box	78 x 11 x 56 cm
Weight	5 kg

Notes:

- Shipped flat packed.
- Ready to assemble, no tools needed.
- Both sides of the trays are made of veneer.

Bølling Tray Table - Veneer Model 60
Hans Bølling

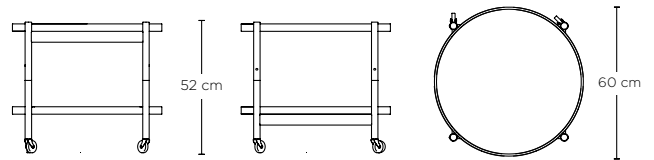

		Euro ex. VAT	#Reference
	Beech, Oil	850	BBO3-BOL-VV
	Beech, Black Lacquer	965	BBO3-BBA-VV
	Oak, Oil	950	BBO3-OOL-VV
	Oak, Black Lacquer	1.065	BBO3-OBA-VV
	Fumed Oak, Oil	1.065	BBO3-OFU-VV
	Walnut, Oil	1.065	BBO3-WOL-VV

Dimensions

Diameter	Ø60 cm
Height	52 cm
Tray Height	2,5 cm
Box	90 x 12 x 60 cm
Weight	6,5 kg

Notes:

- Shipped flat packed.
- Ready to assemble, no tools needed.
- Both sides of the trays are made of veneer.



Jari Table Collection

by OEO Studio

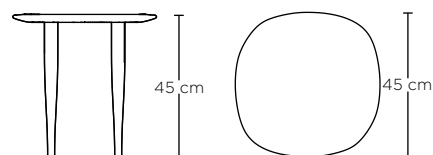

	Euro ex. VAT	#Reference
 Oak, Wax-Oil	1.045	JAJ1-OOL
 Fumed Oak, Wax-Oil	1.185	JAJ1-OFU

Notes:

- Shipped flat packed.
- Ready to assemble, no tools needed.
- Fumed colors will vary accross the table.
Read more under material information.

Dimensions

Diameter	Ø45 cm
Height	45 cm
Solid Wood Table Top Thickness	2,5 cm
Box (top)	47 x 47 x 4 cm
Box (legs)	46 x 21 x 6 cm

Jari Side Table - Model C60
OEO Studio

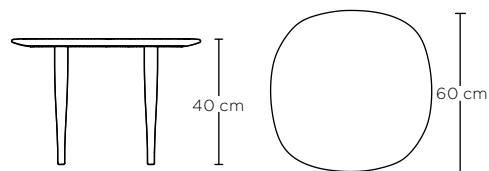

	Euro ex. VAT	#Reference
 Oak, Wax-Oil	1.220	JAJ2-OOL
 Fumed Oak, Wax-Oil	1.360	JAJ2-OFU

Notes:

- Shipped flat packed.
- Ready to assemble, no tools needed.
- Fumed colors will vary accross the table.
Read more under material information.

Dimensions

Diameter	Ø60 cm
Height	40 cm
Solid Wood Table Top Thickness	2,5 cm
Box (top)	63 x 63 x 4 cm
Box (legs)	46 x 21 x 6 cm

Jari Coffee Table Round - Model C85

OEO Studio

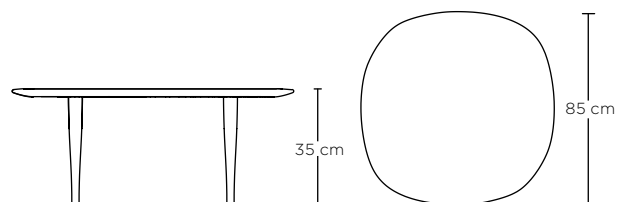

	Euro ex. VAT	#Reference
 Oak, Wax-Oil	1.395	JAJ3-OOL
 Fumed Oak, Wax-Oil	1.535	JAJ3-OFU

Notes:

- Shipped flat packed.
- Ready to assemble, no tools needed.
- Fumed colors will vary accross the table.
Read more under material information.

Dimensions

Diameter	Ø85 cm
Height	35 cm
Solid Wood Table Top Thickness	2,5 cm
Box (top)	88 x 87 x 4 cm
Box (legs)	46 x 21 x 6 cm

Jari Coffee Table Round - Model C118
OEO Studio

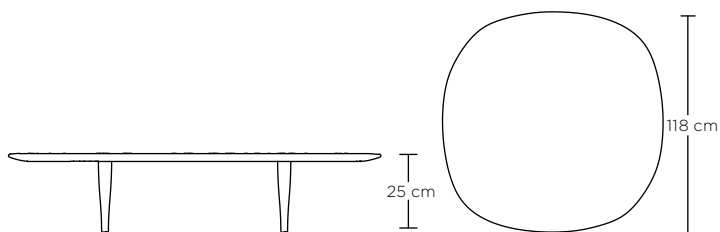

	Euro ex. VAT	#Reference
 Oak, Wax-Oil	2.230	JAJ4-OOL
 Fumed Oak, Wax-Oil	2.370	JAJ4-OFU

Notes:

- Shipped flat packed.
- Ready to assemble, no tools needed.
- Fumed colors will vary accross the table.
Read more under material information.

Dimensions

Diameter	Ø118 cm
Height	25 cm
Solid Wood Table Top Thickness	2,5 cm
Box (top)	125 x 125 x 4 cm
Box (legs)	46 x 21 x 6 cm

Jari Ellipse Coffee Table - Model E130

OEO Studio

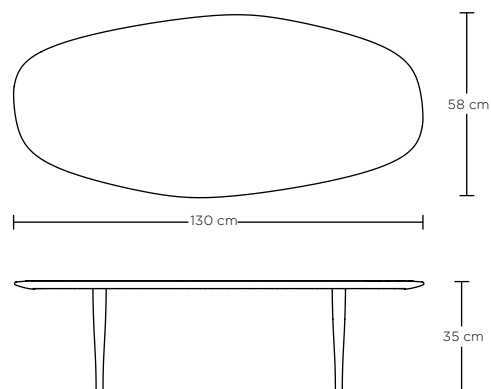

	Euro ex. VAT	#Reference
 Oak, Wax-Oil	2.090	JAJ5-OOL
 Fumed Oak, Wax-Oil	2.230	JAJ5-OFU

Notes:

- Shipped flat packed.
- Ready to assemble, no tools needed.
- Fumed colors will vary accross the table.
Read more under material information.

Dimensions

Length	130 cm
Width	58 cm
Height	35 cm
Solid Oak Table Top Thickness	2,5 cm
Box (top)	133 x 61 x 4 cm
Box (legs)	46 x 21 x 6 cm

Jari Ellipse Coffee Table - Model E180

OEO Studio

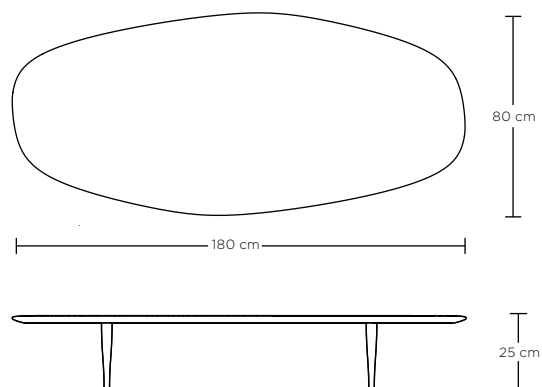

	Euro ex. VAT	#Reference
 Oak, Wax-Oil	2.650	JAJ6-OOL
 Fumed Oak, Wax-Oil	2.790	JAJ6-OFU

Notes:

- Shipped flat packed.
- Ready to assemble, no tools needed.
- Fumed colors will vary accross the table.
Read more under material information.

Dimensions

Length	180 cm
Width	80 cm
Height	25 cm
Solid Oak Table Top Thickness	2,5 cm
Box (top)	183 x 83 x 4 cm
Box (legs)	46 x 21 x 6 cm





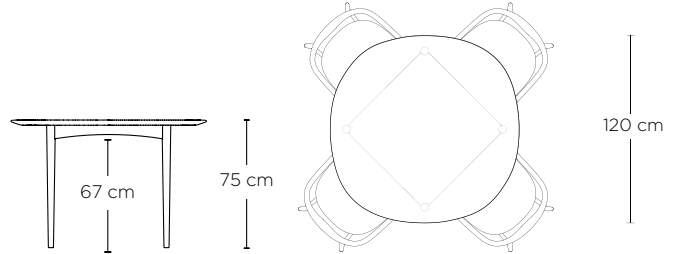

Jari Dining Table

by OEO Studio

Jari Dining Table - Model C120
OEO Studio



		Euro ex. VAT	#Reference
	Oak, Wax-Oil	2.985	JAO6-OOL
	Fumed Oak, Wax-Oil	3.365	JA06-OFU
	Ash, Black Lacquer	3.365	JA06-ABA
	Ash, Blue Lacquer	3.365	JAO6-ABU

Notes:





- Available only for selected dealers.
- Approved for hotel / restaurant (EN 15372: 2016, Test level 2 General)
- Fumed colors will vary accross the table. Read more under material information.
- Shipped knock down.

Dimensions

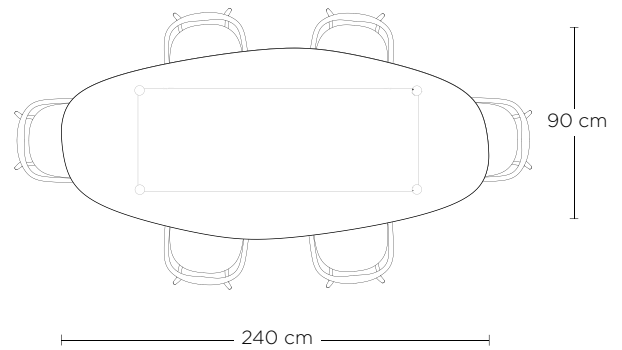
Diameter	Ø120 cm
Height	75 cm
Solid Wood Table Top Thickness	3 cm
Box	122 x 122 x 15 cm
Weight	60 kg

Jari Ellipse Dining Table - Model E240
OEO Studio



	Euro ex. VAT	#Reference
 Oak, Wax-Oil	4.475	JAT3-OOL
 Fumed Oak, Wax-Oil	4.980	JAT3-OFU
 Ash, Black Lacquer	4.980	JAT3-ABA
 Ash, Blue Lacquer	4.980	JAT3-ABU

Notes:

- Available only for selected dealers.
- Approved for hotel / restaurant (EN 15372: 2016, Test level 2 General)
- Fumed colors will vary accross the table. Read more under material information.
- Shipped knock down.

Dimensions

Length	240 cm
Width	105 cm
Height	75 cm
Solid Wood Table Top Thickness	3 cm
Box	250 x 110 x 15 cm
Weight	80 kg



Arv Dining Table

by David Thulstrup

ARV Dining Table - Ø 120 cm
David Thulstrup

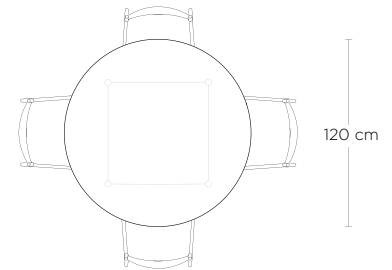
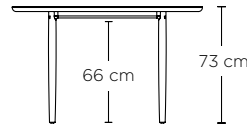

	Euro ex. VAT	#Reference
 Oak, White Wax-Oil	3.645	AVO6-OWO
 Oak, Wax-Oil	3.645	AVO6-OOL
 Fumed Oak, Wax-Oil	4.025	AVO6-OFU

Notes:

- Available only for selected dealers.
- Approved for hotel / restaurant (EN 15372: 2016, Test level 2 General)
- Fumed colors will vary across the table. Read more under material information.
- Shipped assembled.
- Shipped in wooden export box.

Dimensions

Diameter	Ø120 cm
Height	73 cm
Solid Oak Table Top Thickness	2,6 cm
Export Box	122 x 122 x 82 cm
Weight (including box)	106 kg

ARV Dining Table - 90x180 cm
David Thulstrup

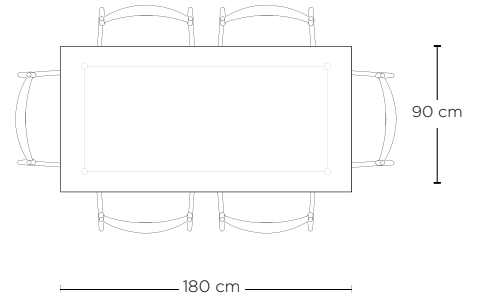

	Euro ex. VAT	#Reference
 Oak, White Wax-Oil	4.690	AVT1-OWO
 Oak, Wax-Oil	4.690	AVT1-OOL
 Fumed Oak, Wax-Oil	5.195	AVT1-OFU

Notes:

- Available only for selected dealers.
- Approved for hotel / restaurant (EN 15372: 2016, Test level 2 General)
- Fumed colors will vary across the table. Read more under material information.
- Shipped assembled.
- Shipped in wooden export box.

Dimensions

Length	180 cm
Width	90 cm
Height	73 cm
Solid Oak Table Top Thickness	2,6 cm
Export Box	190 x 100 x 90 cm
Weight (including box)	124 kg

ARV Dining Table - 90x240 cm
David Thulstrup

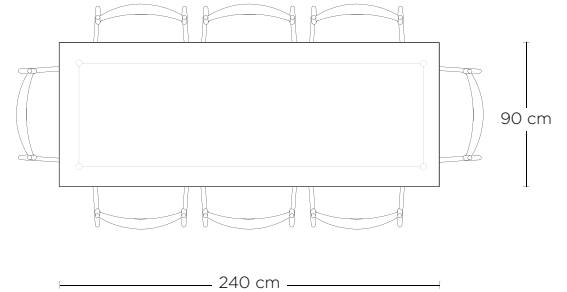

	Euro ex. VAT	#Reference
 Oak, White Wax-Oil	5.325	AVT2-OWO
 Oak, Wax-Oil	5.325	AVT2-OOL
 Fumed Oak, Wax-Oil	5.830	AVT2-OFU

Notes:

- Available only for selected dealers.
- Approved for hotel / restaurant (EN 15372: 2016, Test level 2 General)
- Fumed colors will vary across the table. Read more under material information.
- Shipped assembled.
- Shipped in wooden export box.
- Contact Brdr. Krüger for custom sizes.

Dimensions

Length	240 cm
Width	90 cm
Height	73 cm
Solid Oak Table Top Thickness	2,6 cm
Export Box	250 x 100 x 90 cm
Weight (including box)	172 kg







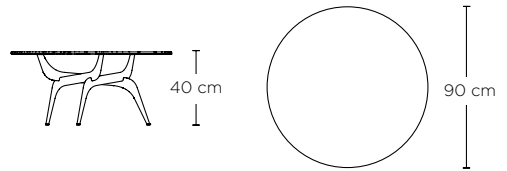

TRIIIIO Table Collection

by Hans Bølling

TRIIIIO Coffee Table
Hans Bølling



	Euro ex. VAT	#Reference
 Oak, Untreated	1.255	TRO5-OUN
 Oak, Wax-Oil	1.330	TRO5-OOL
 Fumed Oak, Wax-Oil	1.520	TRO5-OFU
 Walnut, Wax-Oil	1.520	TRO5-WOL

Glass Colour	# Reference
 Clear	CG
 Bronze	BG





Dimension	
Diameter	Ø90 cm
Height	40 cm
Hardened Glass Thickness	1 cm
Box (glass)	91,5 x 91,5 x 3,5 cm
Box (legs)	78,5 x 26 x 6 cm
Total Weight	19 kg

Notes:

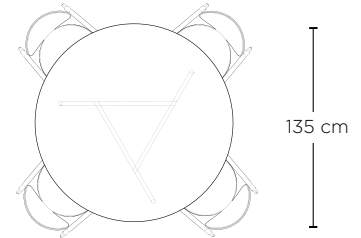
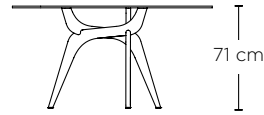
- Shipped flat packed.
- Ready to assemble, no tools needed.
- Fumed colors will vary accross the table.
Read more under material information.

TRIIIIO Dining Table - Ø135 cm
Hans Bølling



	Euro ex. VAT	#Reference
 Oak, Untreated	2.860	TRO7-OUN
 Oak, Wax-Oil	3.000	TRO7-OOL
 Fumed Oak, Wax-Oil	3.210	TRO7-OFU
 Walnut, Wax-Oil	3.210	TRO7-WOL

Glass Colour	# Reference
 Clear	CG
 Bronze	BG

Dimensions	
Diameter	Ø135 cm
Height	71 cm
Hardened Glass Thickness	1 cm
Box (glass)	136 x 136 x 3,5 cm
Box (legs)	86 x 86 x 71 cm
Total Weight	54 kg

Notes:

- Shipped flat packed.
- Ready to assemble, no tools needed.
- Fumed colors will vary accross the table.
Read more under material information.

TRIII Dining Table - Solid Table Top Ø120 cm
Hans Bølling

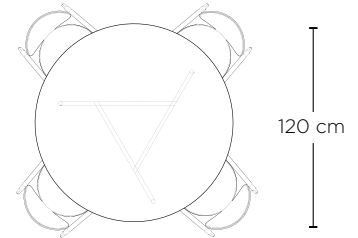
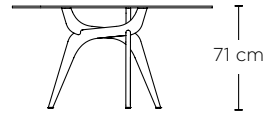

	Euro ex. VAT	#Reference
 Oak, Wax-Oil	3.210	TRO6-OOL-OT
 Fumed Oak, Wax-Oil	3.485	TRO6-OFU-OT

Notes:

- Shipped assembled.
- If requested, shipped flat pack.
- Ready to assemble, no tools needed.
- Fumed colors will vary accross the table.
Read more under material information.

Dimensions

Diameter	Ø120 cm
Height	71 cm
Solid Oak Table Top Thickness	2,6 cm
Box (top)	122 x 122 x 3,5 cm
Box (legs)	86 x 86 x 71 cm
Total Weight	54 kg

Seating



Arv Chair

by David Thulstrup

Arv Chair
David Thulstrup

 BRDR. KRÜGER



Arv Dining Chair
David Thulstrup

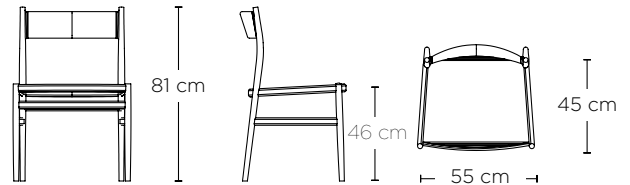

Weaved Seat, Weaved Back

Euro ex. VAT

#Reference

	Oak, White Wax-Oil	1.080	AVCX-OWO-02
	Oak, Wax-Oil	1.080	AVCX-OOL-02
	Fumed Oak, Wax-Oil	1.205	AVCX-OFU-02

Weaved Seat, Solid Back

	Oak, White Wax-Oil	1.015	AVCX-OWO-01
	Oak, Wax-Oil	1.015	AVCX-OOL-01
	Fumed Oak, Wax-Oil	1.140	AVCX-OFU-01

Notes:

- Available only for selected dealers.
- Approved for hotel / restaurant (EN 15372: 2016, Test level 2 General)
- Felt gliders.
- Fumed colors will vary across the chair as the wood content of tanin will vary.
Read more under material information.

Dimensions

Height	81 cm
Width	55 cm
Seat Height	46 cm
Seat Depth	45 cm
Box	63 x 58 x 89 cm
Weight	5,5 kg

Arv Dining Chair
David Thulstrup

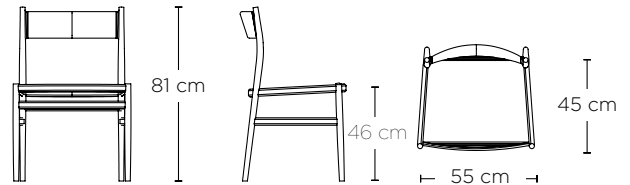

Leather Seat, Solid Back



Euro ex. VAT

#Reference

	Oak, White Wax-Oil	950	AVCX-OWO
	Oak, Wax-Oil	950	AVCX-OOL
	Fumed Oak, Wax-Oil	1.015	AVCX-OFU

Upholstery

Reference

	Spectrum, Brandy Leather - 30155	66
	Spectrum, Cinnamon Leather - 30146	65

Dimensions

Height	81 cm
Width	55 cm
Seat Height	46 cm
Seat Depth	45 cm
Box	63 x 58 x 89 cm
Weight	5,5 kg

Notes:

- Available only for selected dealers.
- Approved for hotel / restaurant (EN 15372: 2016, Test level 2 General)
- Felt gliders.
- Fumed colors will vary across the chair as the wood content of tanin will vary.
Read more under material information.

ARV Dining Chair with Armrest
David Thulstrup

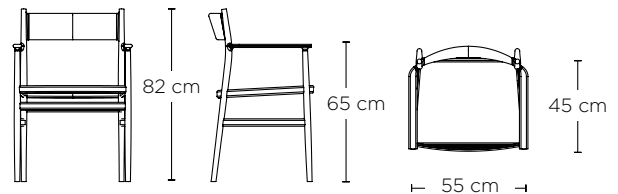

Weaved Seat, Weaved Back

	Euro ex. VAT	#Reference
 Oak, White Wax-Oil	1.300	AVCA-OWO-02
 Oak, Wax-Oil	1.300	AVCA-OOL-02
 Fumed Oak, Wax-Oil	1.440	AVCA-OFU-02

Weaved Seat, Solid Back

 Oak, White Wax-Oil	1.235	AVCA-OWO-01
 Oak, Wax-Oil	1.235	AVCA-OOL-01
 Fumed Oak, Wax-Oil	1.325	AVCA-OFU-01

Notes:

- Available only for selected dealers.
- Approved for hotel / restaurant (EN 15372: 2016, Test level 2 General)
- Felt gliders.
- Fumed colors will vary across the chair as the wood content of tanin will vary.
Read more under material information.

Dimensions

Height	82 cm
Width	55 cm
Seat Height	46 cm
Seat Depth	45 cm
Arm Height	65,3 cm
Box	63 x 58 x 89 cm
Weight	6 kg

ARV Dining Chair with Armrest
David Thulstrup

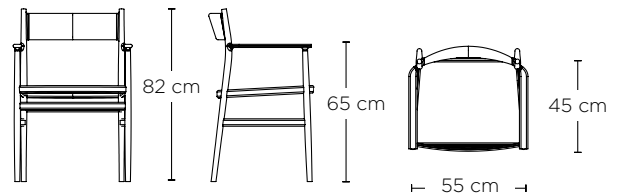

Leather Seat, Solid Back



Euro ex. VAT

#Reference

	Oak, White Wax-Oil	1.165	AVCA-OWO
	Oak, Wax-Oil	1.165	AVCA-OOL
	Fumed Oak, Wax-Oil	1.235	AVCA-OFU

Upholstery

Reference

	Spectrum, Brandy Leather - 30155	66
	Spectrum, Cinnamon Leather - 30146	65

Dimensions

Height	82 cm
Width	55 cm
Seat Height	46 cm
Seat Depth	45 cm
Arm Height	65,3 cm
Box	63 x 58 x 89 cm
Weight	6 kg

Notes:

- Available only for selected dealers.
- Approved for hotel / restaurant (EN 15372: 2016, Test level 2 General)
- Felt gliders.
- Fumed colors will vary across the chair as the wood content of tanin will vary.
Read more under material information.

Arv Lounge Chair

David Thulstrup

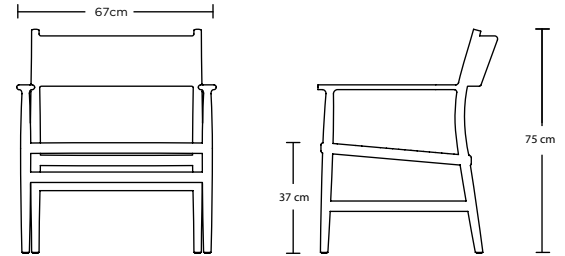

	Weaved Seat, Weaved Back	Euro ex. VAT	#Reference
	Oak, White Wax-Oil	2.535	AVCL-OWO-02
	Oak, Wax-Oil	2.535	AVCL-OOL-02
	Fumed Oak, Wax-Oil	2.665	AVCL-OFU-02

Notes:

- Available only for selected dealers.
 - Approved for hotel / restaurant (EN 15372: 2016, Test level 2 General)
 - Felt gliders.
 - Fumed colors will vary across the chair as the wood content of tanin will vary.
- Read more under material information.

Dimensions

Height	75 cm
Width	67 cm
Seat Depth	65 cm
Seat Height	37 cm
Box	78 x 78 x 72 cm
Weight	15 kg



Arkade Chair

by Nanna Ditzel

Arkade Chair
Nanna Ditzel



 BRDR. KRÜGER



Arkade Dining Chair
Nanna Ditzel



Fabric	Euro ex. VAT	#Reference
 Oak, White Wax-Oil	890	ARCA-OWO
 Oak, Wax-Oil	890	ARCA-OOL
 Fumed Oak, Wax-Oil	1.030	ARCA-OFU

Metal Frame Powder Coating	# Reference
 Black	BO
 Brass	BR
 Chrome	CH

Upholstery	# Reference
 Hallingdal, Grey Fabric - 0113	35
 Moss, Cream Fabric - 0019	33

Dimensions	
Height	83 cm
Width	55,4 cm
Seat Height	46,5 cm
Seat Depth	59,5 cm
Armrest Height	68,8 cm
Box	68 x 63 x 85 cm
Weight	10 kg



Notes:

- Felt gliders.
- Fumed colors will vary across the chair as the wood content of tanin will vary.
Read more under material information.





Arkade Dining Chair
Nanna Ditzel



Leather	Euro ex. VAT	#Reference
 Oak, White Wax-Oil	1.230	ARCA-OWO
 Oak, Wax-Oil	1.230	ARCA-OOL
 Fumed Oak, Wax-Oil	1.370	ARCA-OFU

Metal Frame Powder Coating	# Reference
 Black	BO
 Brass	BR
 Chrome	CH

Dimensions	
Height	83 cm
Width	55,4 cm
Seat Height	46,5 cm
Seat Depth	59,5 cm
Armrest Height	68,8 cm
Box	68 x 63 x 85 cm
Weight	10 kg

Upholstery	# Reference
 Spectrum, Oyster Leather - 30157	62
 Spectrum, Almond Leather - 30150	63
 Spectrum, Brandy Leather - 30155	66
 Spectrum, Cinnamon Leather - 30146	65
 Savanne, Black Leather - 30314	61



Notes:

- Felt gliders.
- Fumed colors will vary across the chair as the wood content of tannin will vary.
Read more under material information.

Arkade Dining Chair
Nanna Ditzel



Wood Seat and Back		Euro ex. VAT	#Reference
	Oak, White Wax-Oil	630	ARCA-OOL-BO -03
	Oak, Wax-Oil	630	ARCA-OUN-BO -03
	Fumed Oak, Wax-Oil	700	ARCA-OFU-BO -03

Metal Frame Powder Coating	# Reference
	Black BO
	Brass BR
	Chrome CH

Dimensions	
Height	83 cm
Width	55,4 cm
Seat Height	46,5 cm
Seat Depth	59,5 cm
Armrest Height	68,8 cm
Box	68 x 63 x 85 cm
Weight	10 kg

Notes:

- Felt gliders.
- Fumed colors will vary across the chair as the wood content of tanin will vary.
Read more under material information.



F Chair

by Rasmus B. Fex





F Chair
Rasmus B. Fex

 BRDR. KRÜGER

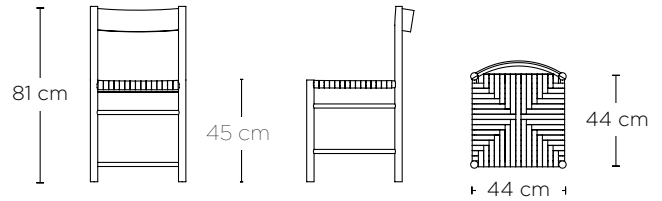

F Dining Chair
Rasmus B. Fex



	Euro ex. VAT	#Reference
 Oak, Wax-Oil, Black Webbing Seat	535	FCCX-OOL-11
 Fumed Oak, Wax-Oil, Natural Linen, Webbing Seat	595	FCCX-OFU-04
 Ash, Black Lacquer, Black Webbing Seat	535	FCCX-ABA-11
 Ash, Green Lacquer, Green Webbing Seat	535	FCCX-AGR-12
 Ash, Red Lacquer, Red Webbing Seat	535	FCCX-ARE-13

Notes:





- Approved for hotel / restaurant (EN 15372: 2016, Test level 2 General)
- Felt gliders.

Dimensions

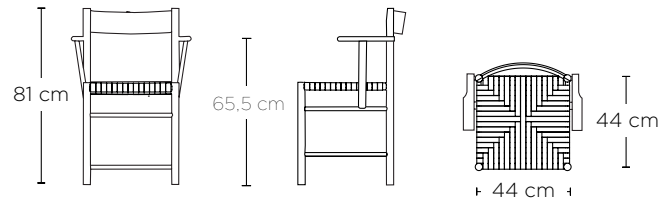
Height	81 cm
Width	43,5 cm
Seat Height	45 cm
Seat Width	44 cm
Box	49 x 49 x 84 cm
Weight	5 kg

F Dining Chair with Armrest
Rasmus B. Fex



	Euro ex. VAT	#Reference
 Oak, Wax-Oil, Black Webbing Seat	675	FCCA-OOL-11
 Fumed Oak, Wax-Oil, Natural Linen, Webbing Seat	735	FCCA-OFU-04
 Ash, Black Lacquer, Black Webbing Seat	675	FCCA-ABA-11
 Ash, Green Lacquer, Green Webbing Seat	675	FCCA-AGR-12
 Ash, Red Lacquer, Red Webbing Seat	675	FCCA-ARE-13

Notes:

- Approved for hotel / restaurant (EN 15372: 2016, Test level 2 General)
- Felt gliders.





Dimensions

Height	81 cm
Width	54,5 cm
Seat Height	45 cm
Seat Width	44 cm
Arm Height	65,5 cm
Box	65 x 58 x 87 cm
Weight	5,5 kg

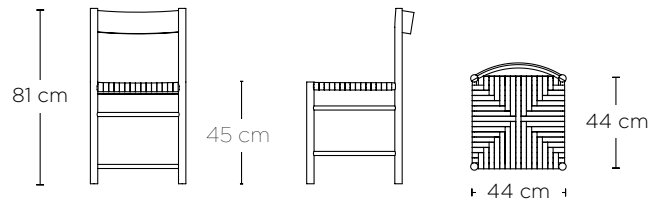
F Dining Chair with Paper Cord

Rasmus B. Fex



	Paper Cord	Euro ex. VAT	#Reference
	Oak, Wax-Oil	745	FCCX-OOL-01
	Fumed Oak, Wax-Oil	805	FCCX-OFU-01
	Ash, Black Lacquer	745	FCCX-ABA-01
	Ash, Green Lacquer	745	FCCX-AGR-01
	Ash, Red Lacquer	745	FCCX-ARE-01

Notes:

- Approved for hotel / restaurant use:
EN 1022:2005, EN 16139:2013
- Felt gliders.
- Seat in paper cord.
The weaving is a traditional Danish triangle shape used for generations. Since cords need to overlap it is not possible to make four triangles that meet exactly in the middle - they will always overlap. Also, the four lines going from the edge of the seat to the center will never be 100 pct. straight. This is a handmade product and part of the character of the chair.





Dimensions

Height	81 cm
Width	43,5 cm
Seat Height	45 cm
Seat Width	44 cm
Box	49 x 49 x 84 cm
Weight	5 kg

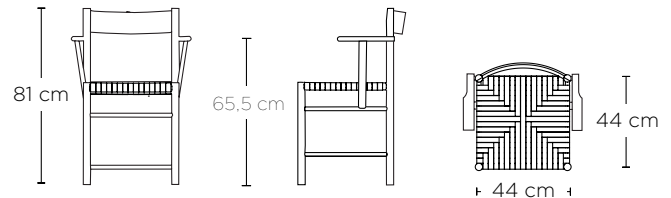
F Dining Chair with Armrest and Paper Cord

Rasmus B. Fex



	Paper Cord	Euro ex. VAT	#Reference
	Oak, Wax-Oil	885	FCCA-OOL-01
	Fumed Oak, Wax-Oil	950	FCCA-OFU-01
	Ash, Black Lacquer	885	FCCA-ABA-01
	Ash, Green Lacquer	885	FCCA-AGR-01
	Ash, Red Lacquer	885	FCCA-ARE-01

Notes:

- Approved for hotel / restaurant use:
EN 1022:2005, EN 16139:2013
- Felt gliders.
- Seat in paper cord.
The weaving is a traditional Danish triangle shape used for generations. Since cords need to overlap it is not possible to make four triangles that meet exactly in the middle - they will always overlap. Also, the four lines going from the edge of the seat to the center will never be 100 pct. straight. This is a handmade product and part of the character of the chair.

Dimensions

Height	81 cm
Width	54,5 cm
Seat Height	45 cm
Seat Width	44 cm
Armrest Height	65,5 cm
Box	65 x 58 x 87 cm
Weight	5,5 kg



Pauline Bar Stool

by OEO Studio

Pauline Bar Stool
OEO Studio





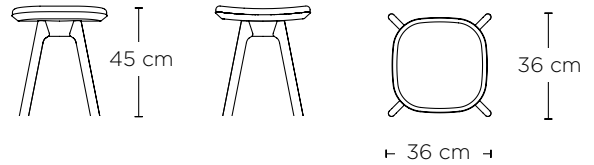

 BRDR. KRÜGER





Fabric	Euro ex. VAT	#Reference
 Oak, Wax-Oil	560	PA45-OOL
 Fumed Oak, Wax-Oil	645	PA45-OFU
 Oak, Black Lacquer	645	PA45-OBA

Leather	Euro ex. VAT	#Reference
 Oak, Wax-Oil	645	PA45-OOL
 Fumed Oak, Wax-Oil	700	PA45-OFU
 Oak, Black Lacquer	700	PA45-OBA

Upholstery	# Reference	Dimensions
 Hallingdal, Grey Fabric - 0113	35	Height 45 cm
 Moss, Cream Fabric - 0019	33	Length 36 cm
 Spectrum, Oyster Leather - 30157	62	Width 36 cm
 Spectrum, Almond Leather - 30150	63	Box 42 x 42 x 50 cm
 Spectrum, Brandy Leather - 30155	66	Weight 5 kg
 Spectrum, Cinnamon Leather - 30146	65	
 Savanne, Black Leather - 30314	61	

Note:





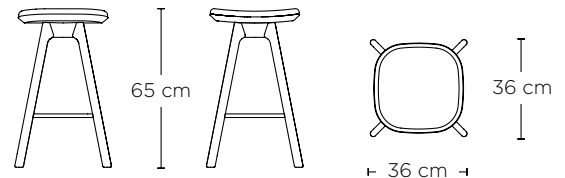

- Approved for hotel / restaurant use:
EN 1022:2005, EN 16139:2013.
- Plastic glider.

Pauline Bar Stool 65 cm
OEO Studio



Fabric	Euro ex. VAT	#Reference
 Oak, Wax-Oil	770	PA65-OOL
 Fumed Oak, Wax-Oil	850	PA65-OFU
 Oak, Black Lacquer	850	PA65-OBA

Leather	Euro ex. VAT	#Reference
 Oak, Wax-Oil	850	PA65-OOL
 Fumed Oak, Wax-Oil	925	PA65-OFU
 Oak, Black Lacquer	925	PA65-OBA

Upholstery	# Reference	Dimensions
 Hallingdal, Grey Fabric - 0113	35	Height 65 cm
 Moss, Cream Fabric - 0019	33	Length 36 cm
 Spectrum, Oyster Leather - 30157	62	Width 36 cm
 Spectrum, Almond Leather - 30150	63	Box 42 x 42 x 70 cm.
 Spectrum, Brandy Leather - 30155	66	Weight 6 kg
 Spectrum, Cinnamon Leather - 30146	65	
 Savanne, Black Leather - 30314	61	

Note:







- Approved for hotel / restaurant use:
EN 1022:2005, EN 16139:2013.
- Plastic glider.

Pauline Comfort Bar Stool 65 cm
OEO Studio



Fabric	Euro ex. VAT	#Reference
 Oak, Wax-Oil	1.055	PA66-OOL
 Fumed Oak, Wax-Oil	1.130	PA66-OFU
 Oak, Black Lacquer	1.130	PA66-OBA

Leather	Euro ex. VAT	#Reference
 Oak, Wax-Oil	1.195	PA66-OOL
 Fumed Oak, Wax-Oil	1.270	PA66-OFU
 Oak, Black Lacquer	1.270	PA66-OBA

Upholstery	# Reference	Dimensions
 Hallingdal, Grey Fabric - 0113	35	Height 97 cm
 Moss, Cream Fabric - 0019	33	Seat Height 65 cm
 Spectrum, Oyster Leather - 30157	62	Length 36 cm
 Spectrum, Almond Leather - 30150	63	Width 36 cm
 Spectrum, Brandy Leather - 30155	66	Box 48,5 x 48,5 x 98 cm.
 Spectrum, Cinnamon Leather - 30146	65	Weight 8 kg
 Savanne, Black Leather - 30314	61	







- Note:**
- Approved for hotel / restaurant use: EN 1022:2005, EN 16139:2013.
 - Plastic glider.

Pauline Bar Stool 65 cm with metal legs
OEO Studio



Fabric	Euro ex. VAT	#Reference
 Oak, Wax-Oil	630	PA65-OOL-BM
 Fumed Oak, Wax-Oil	705	PA65-OFU-BM
 Oak, Black Lacquer	705	PA65-OBA-BM

Leather	Euro ex. VAT	#Reference
 Oak, Wax-Oil	705	PA65-OOL-BM
 Fumed Oak, Wax-Oil	770	PA65-OFU-BM
 Oak, Black Lacquer	770	PA65-OBA-BM

Upholstery	# Reference
 Hallingdal, Grey Fabric - 0113	35
 Moss, Cream Fabric - 0019	33
 Spectrum, Oyster Leather - 30157	62
 Spectrum, Almond Leather - 30150	63
 Spectrum, Brandy Leather - 30155	66
 Spectrum, Cinnamon Leather - 30146	65
 Savanne, Black Leather - 30314	61

Dimensions	
Height	65 cm
Length	36 cm
Width	36 cm
Box	42 x 42 x 70 cm.
Weight	6 kg

Note:

- Approved for hotel / restaurant use: EN 1022:2005, EN 16139:2013.
- Plastic glider.
- Steel legs and footrest, powder coated matt black.

Pauline Bar Stool 65 cm with wooden seat
OEO Studio



	Euro ex. VAT	#Reference
 Oak, Wax-Oil	490	PA65-OOL-BM-05
 Fumed Oak, Wax-Oil	560	PA65-OFU-BM-05
 Oak, Black Lacquer	560	PA65-OBA-BM-05

Note:

- Approved for hotel / restaurant use:
EN 1022:2005, EN 16139:2013.
- Plastic glider.
- Steel legs and footrest, powder coated matt black.
- Seat in solid oak.

Dimensions







Height	65 cm
Length	36 cm
Width	36 cm
Box	42 x 42 x 70 cm.
Weight	6 kg

Pauline Comfort Bar Stool 65 cm with metal legs
OEO Studio



Fabric	Euro ex. VAT	#Reference
 Oak, Wax-Oil	910	PA66-OOL-BM
 Fumed Oak, Wax-Oil	980	PA66-OFU-BM
 Oak, Black Lacquer	980	PA66-OBA-BM

Leather	Euro ex. VAT	#Reference
 Oak, Wax-Oil	1.050	PA66-OOL-BM
 Fumed Oak, Wax-Oil	1.120	PA66-OFU-BM
 Oak, Black Lacquer	1.120	PA66-OBA-BM

Upholstery	# Reference	Dimensions
 Hallingdal, Grey Fabric - 0113	35	Height 97 cm
 Moss, Cream Fabric - 0019	33	Seat Height 65 cm
 Spectrum, Oyster Leather - 30157	62	Length 36 cm
 Spectrum, Almond Leather - 30150	63	Width 36 cm
 Spectrum, Brandy Leather - 30155	66	Box 48,5 x 48,5 x 98 cm.
 Spectrum, Cinnamon Leather - 30146	65	Weight 7 kg
 Savanne, Black Leather - 30314	61	





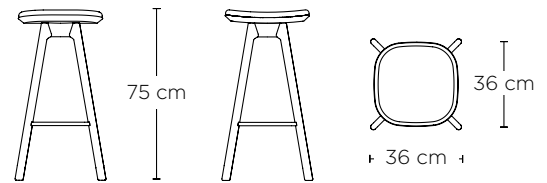

- Note:**
- Approved for hotel / restaurant use: EN 1022:2005, EN 16139:2013.
 - Plastic glider.
 - Steel legs and footrest, powder coated matt black.

Pauline Bar Stool 75 cm
OEO Studio



Fabric	Euro ex. VAT	#Reference
 Oak, Wax-Oil	770	PA75-OOL
 Fumed Oak, Wax-Oil	850	PA75-OFU
 Oak, Black Lacquer	850	PA75-OBA

Leather	Euro ex. VAT	#Reference
 Oak, Wax-Oil	850	PA75-OOL
 Fumed Oak, Wax-Oil	925	PA75-OFU
 Oak, Black Lacquer	925	PA75-OBA

Upholstery	# Reference	Dimensions
 Hallingdal, Grey Fabric - 0113	35	Height 75 cm
 Moss, Cream Fabric - 0019	33	Length 36 cm
 Spectrum, Oyster Leather - 30157	62	Width 36 cm
 Spectrum, Almond Leather - 30150	63	Box 46 x 46 x 80 cm.
 Spectrum, Brandy Leather - 30155	66	Weight 7 kg
 Spectrum, Cinnamon Leather - 30146	65	
 Savanne, Black Leather - 30314	61	

Note:





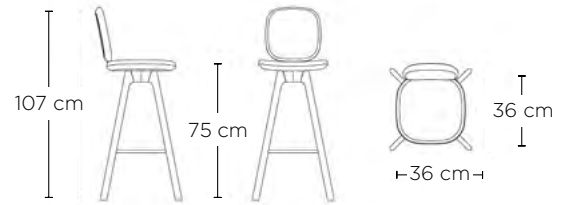

- Approved for hotel / restaurant use: EN 1022:2005, EN 16139:2013.
- Plastic glider.
- Steel legs and footrest, powder coated matt black.

Pauline Comfort Bar Stool 75 cm
OEO Studio



Fabric	Euro ex. VAT	#Reference
 Oak, Wax-Oil	1.055	PA76-OOL
 Fumed Oak, Wax-Oil	1.130	PA76-OFU
 Oak, Black Lacquer	1.130	PA76-OBA

Leather	Euro ex. VAT	#Reference
 Oak, Wax-Oil	1.195	PA76-OOL
 Fumed Oak, Wax-Oil	1.270	PA76-OFU
 Oak, Black Lacquer	1.270	PA76-OBA

Upholstery	# Reference	Dimensions
 Hallingdal, Grey Fabric - 0113	35	Height 107 cm
 Moss, Cream Fabric - 0019	33	Seat Height 75 cm
 Spectrum, Oyster Leather - 30157	62	Length 36 cm
 Spectrum, Almond Leather - 30150	63	Width 36 cm
 Spectrum, Brandy Leather - 30155	66	Box 48 x 48 x 110 cm
 Spectrum, Cinnamon Leather - 30146	65	Weight 8,5 kg
 Savanne, Black - Leather 30314	61	







- Note:**
- Approved for hotel / restaurant use:
EN 1022:2005, EN 16139:2013.
 - Plastic glider.

Pauline Bar Stool 75 cm metal legs
OEO Studio



Fabric	Euro ex. VAT	#Reference
 Oak, Wax-Oil	630	PA75-OOL-BM
 Fumed Oak, Wax-Oil	705	PA75-OFU-BM
 Oak, Black Lacquer	705	PA75-OBA-BM

Leather	Euro ex. VAT	#Reference
 Oak, Wax-Oil	705	PA75-OOL-BM
 Fumed Oak, Wax-Oil	770	PA75-OFU-BM
 Oak, Black Lacquer	770	PA75-OBA-BM

Upholstery	# Reference
 Hallingdal, Grey Fabric - 0113	35
 Moss, Cream Fabric - 0019	33
 Spectrum, Oyster Leather - 30157	62
 Spectrum, Almond Leather - 30150	63
 Spectrum, Brandy Leather - 30155	66
 Spectrum, Cinnamon Leather - 30146	65
 Savanne, Black Leather - 30314	61

Dimensions	
Height	75 cm
Length	36 cm
Width	36 cm
Box	46 x 46 x 80 cm.
Weight	6 kg

Note:

- Approved for hotel / restaurant use: EN 1022:2005, EN 16139:2013.
- Plastic glider.
- Steel legs and footrest, powder coated matt black.

Pauline Barstol 75 cm with wooden seat
OEO Studio



	Euro ex. VAT	#Reference
 Oak, Wax-Oil	490	PA75-OOL-BM-05
 Fumed Oak, Wax-Oil	560	PA75-OFU-BM-05
 Oak, Black Lacquer	560	PA75-OBA-BM-05

Note:



- Approved for hotel / resturant use:
EN 1022:2005, EN 16139:2013.
- Plastic glider.
- Steel legs and footrest, powder coated matt black.
- Seat in solid oak.



Dimensions







Height	75 cm
Length	36 cm
Width	36 cm
Box	46 x 46 x 80 cm.
Weight	6 kg

Pauline Comfort Bar Stool 75 cm metal legs
OEO Studio



Fabric	Euro ex. VAT	#Reference
 Oak, Wax-Oil	910	PA76-OOL-BM
 Fumed Oak, Wax-Oil	980	PA76-OFU-BM
 Oak, Black Lacquer	980	PA76-OBA-BM

Leather	Euro ex. VAT	#Reference
 Oak, Wax-Oil	1.050	PA76-OOL-BM
 Fumed Oak, Wax-Oil	1.120	PA76-OFU-BM
 Oak, Black Lacquer	1.120	PA76-OBA-BM

Upholstery	# Reference	Dimensions
 Hallingdal, Grey Fabric - 0113	35	Height 107 cm
 Moss, Cream Fabric - 0019	33	Seat Height 75 cm
 Spectrum, Oyster Leather - 30157	62	Length 36 cm
 Spectrum, Almond Leather - 30150	63	Width 36 cm
 Spectrum, Brandy Leather - 30155	66	Box 48 x 48 x 110 cm
 Spectrum, Cinnamon Leather - 30146	65	Weight 8,5 kg
 Savanne, Black Leather - 30314	61	







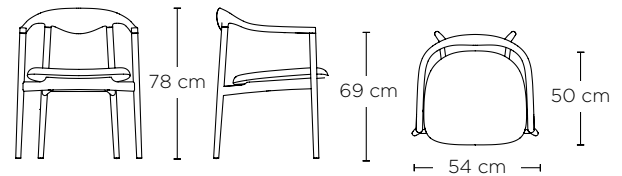

- Note:**
- Approved for hotel / restaurant use: EN 1022:2005, EN 16139:2013.
 - Plastic glider.
 - Steel legs and footrest, powder coated matt black.









Jari Chair

by OEO Studio



Fabric	Euro ex. VAT	#Reference
 Ash, White Wax-Oil	1.395	JACA-AWO
 Ash, Black Lacquer	1.600	JACA-ABA
 Oak, Wax-Oil	1.520	JACA-OOL
 Fumed Oak, Wax-Oil	1.600	JACA-OFU
Leather		
 Ash, White Wax-Oil	1.520	JACA-AWO
 Ash, Black Lacquer	1.725	JACA-ABA
 Oak, Wax-Oil	1.650	JACA-OOL
 Fumed Oak, Wax-Oil	1.725	JACA-OFU

Upholstery	# Reference	Dimensions
 Hallingdal, Grey Fabric - 0113	35	Height 78 cm
 Moss, Cream Fabric - 0019	33	Width 54 cm
 Spectrum, Oyster Leather - 30157	62	Seat Height 46 cm
 Spectrum, Almond Leather - 30150	63	Seat Depth 50 cm
 Spectrum, Brandy Leather - 30155	66	Armrest Height 69 cm
 Spectrum, Cinnamon Leather - 30146	65	Box 66 x 63 x 79 cm
 Savanne, Black Leather - 30314	61	Weight 10 kg

Notes:

- Felt gliders.
- Fumed colors will vary across the chair as the wood content of tanin will vary.



Ferdinand Lounge Chair





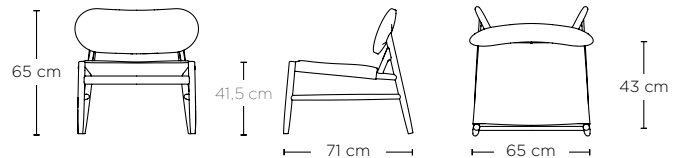

by OEO Studio

Ferdinand Lounge Chair
OEO Studio



Fabric	Euro ex. VAT	#Reference
 Oak, Wax-Oil	2.175	FECX-OOL
 Fumed Oak, Wax-Oil	2.310	FECX-OFU
 Oak, Black Lacquer	2.310	FECX-OBA

Leather	Euro ex. VAT	#Reference
 Oak, Wax-Oil	2.300	FECX-OOL
 Fumed Oak, Wax-Oil	2.440	FECX-OFU
 Oak, Black Lacquer	2.440	FECX-OBA

Upholstery	# Reference	Dimensions
 Hallingdal, Grey Fabric - 0113	35	Height 65 cm
 Moss, Cream Fabric - 0019	33	Width 68 cm
 Spectrum, Oyster Leather - 30157	62	Seat Depth 43 cm
 Spectrum, Almond Leather - 30150	63	Seat Height 41,5 cm
 Spectrum, Brandy Leather - 30155	66	Box 78 x 78 x 72 cm
 Spectrum, Cinnamon Leather - 30146	65	Weight 15 kg
 Savanne, Black Leather - 30314	61	

Notes:

- Felt gliders.
- Fumed colors will vary across the chair as the wood content of tanin will vary.





Karm Sofa

by David Thulstrup

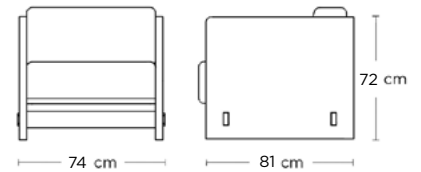
Karm Lounge Chair
David Thulstrup



	Euro ex. VAT	#Reference
 Oak, Wax-Oil	4.055	KA1S-OOL
 Fumed Oak, Wax-Oil	4.310	KA1S-OFU

Upholstery	# Reference
 Hallingdal, Grey Fabric - 0113	35
 Moss, Cream Fabric - 0019	33

Dimensions	
Length	74 cm
Height	72 cm
Width	81 cm
Seat Depth	57 cm
Seat Height	42 cm



Notes:

- The very core of the KARM sofa's design comes from the strong variation in the wood that makes every piece unique. Some sofas have small or large knots and some will have a strong grain texture while others will have less.

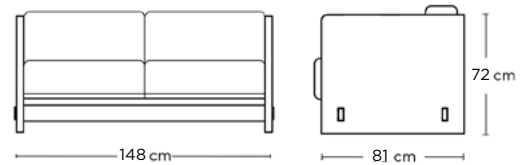
Karm Sofa 2 Seaters
David Thulstrup



	Euro ex. VAT	#Reference
 Oak, Wax-Oil	5.825	KA2S-OOL
 Fumed Oak, Wax-Oil	6.335	KA2S-OFU

Upholstery	# Reference
 Hallingdal, Grey Fabric - 0113	35
 Moss, Cream Fabric - 0019	33

Dimensions	
Length	148 cm
Height	72 cm
Width	81 cm
Seat Depth	57 cm
Seat Height	42 cm

Notes:

- The very core of the KARM sofa's design comes from the strong variation in the wood that makes every piece unique. Some sofas have small or large knots and some will have a strong grain texture while others will have less.

Karm Sofa 3 Seaters
David Thulstrup

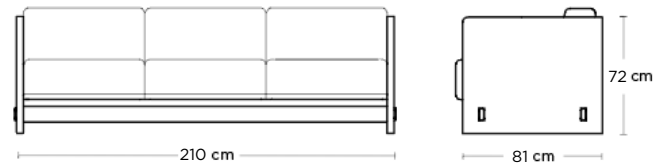

	Euro ex. VAT	#Reference
 Oak, Wax-Oil	7.430	KA3S-OOL
 Fumed Oak, Wax-Oil	7.935	KA3S-OFU

Upholstery	# Reference
 Hallingdal, Grey Fabric - 0113	35
 Moss, Cream Fabric - 0019	33

Dimensions	
Length	210 cm
Height	72 cm
Width	81 cm
Seat Depth	57 cm
Seat Height	42 cm

Notes:

- The very core of the KARM sofa's design comes from the strong variation in the wood that makes every piece unique. Some sofas have small or large knots and some will have a strong grain texture while others will have less.

Lighting



Lune Lamp

by Sverre Uhnger

Lune Table Lamp
Sverre Uhnger

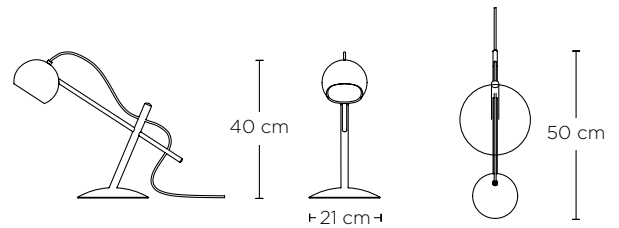

	Euro ex. VAT	#Reference
 Oak, White Wax-Oil, White Electric Cord	635	LUTL-OWO
 Oak, Wax-Oil, Black Electric Cord	635	LUTL-OOL
 Fumed Oak, Wax-Oil, Black Electric Cord	710	LUTL-OFU

Notes:

- Bulb is not included.
- * LED bulb GU 10, max 6 watt.
- * Only approved for EU area.

Dimensions

Length	50 cm
Height	40 cm
Shade	Ø 14 cm
Box	21 cm
Base	59 x 39 x 24 cm
Weight	4 kg

Lune Pendant Lamp
Sverre Uhnger

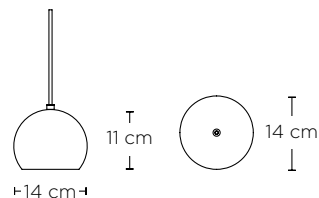

	Euro ex. VAT	#Reference
 Oak, White Wax-Oil, White Electric Cord	280	LUPE-OWO
 Oak, Wax-Oil, Black Electric Cord	280	LUPE-OOL
 Fumed Oak, Wax-Oil, Black Electric Cord	355	LUPE-OFU

Notes:

- Bulb is not included.
- * LED bulb GU 10, max 6 watt.
- * Only approved for EU area.









Dimensions









Shade	Ø 14 cm
Wire	3 m
Box	20 x 20 x 26 cm
Weight	0,7 kg

Complements

Bølling Serving Tray - Model 50
Hans Bølling



















		Euro ex. VAT	#Reference
	Beech, Untreated	205	BBB1-BUN
	Beech, Oil	230	BBB1-BOL
	Beech, Black Lacquer	245	BBB1-BBA
	Oak, Untreated	230	BBB1-OUN
	Oak, Oiled	255	BBB1-OOL
	Oak, Black Lacquer	270	BBB1-OBA
	Fumed Oak, Oil	270	BBB1-OFU
	Walnut, Oil	270	BBB1-WOL

Tray Colour	# Reference	Dimensions
 BASE (Black / White)	BA	Diameter Ø50 cm
 STONE (Grey / Dark Grey)	ST	Height 3 cm
 EARTH (Beige / Brown)	EA	Box 52 x 52 x 4 cm
 LEAF (Green / Dark Green)	LE	Weight 2 kg
 WATER (Blue / Dark Blue)	WA	
 SUNNY (Cream / Yellow)	SU	
 CLAY (Cognac / Black)	CL	
 RED (Red / Black)	RE	

Bølling Serving Tray - Model 60
Hans Bølling









		Euro ex. VAT	#Reference
	Beech, Untreated	245	BBB2-BUN
	Beech, Oil	270	BBB2-BOL
	Beech, Black Lacquer	280	BBB2-BBA
	Oak, Untreated	270	BBB2-OUN
	Oak, Oiled	295	BBB2-OOL
	Oak, Black Lacquer	305	BBB2-OBA
	Fumed Oak, Oil	305	BBB2-OFU
	Walnut, Oil	305	BBB2-WOL

Tray Colour		# Reference	Dimensions	
	BASE (Black / White)	BA	Diameter	Ø60 cm
	STONE (Grey / Dark Grey)	ST	Height	2,5 cm
	EARTH (Beige / Brown)	EA	Box	62 x 62 x 4 cm
	LEAF (Green / Dark Green)	LE	Weight	2,5 kg
	WATER (Blue / Dark Blue)	WA		
	SUNNY (Cream / Yellow)	SU		
	CLAY (Cognac / Black)	CL		
	RED (Red / Black)	RE		

Bølling Serving Tray - Veneer Model 50

Hans Bølling



		Euro ex. VAT	#Reference
	Beech, Oil	270	BBB1-BOL-VV
	Beech, Black Lacquer	280	BBB1-BBA-VV
	Oak, Oiled	295	BBB1-OOL-VV
	Oak, Black Lacquer	305	BBB1-OBA-VV
	Fumed Oak, Oil	305	BBB1-OFU-VV
	Walnut, Oil	305	BBB1-WOL-VV







Dimensions

Diameter	Ø50 cm
Height	3 cm
Box	52 x 52 x 4 cm
Weight	2 kg

Bølling Serving Tray - Veneer Model 60

Hans Bølling



		Euro ex. VAT	#Reference
	Beech, Oil	305	BBB2-BOL-VV
	Beech, Black Lacquer	320	BBB2-BBA-VV
	Oak, Oiled	330	BBB2-OOL-VV
	Oak, Black Lacquer	345	BBB2-OBA-VV
	Fumed Oak, Oil	345	BBB2-OFU-VV
	Walnut, Oil	345	BBB2-WOL-VV

Dimensions

Diameter	Ø60 cm
Height	2,5 cm
Box	62 x 62 x 4 cm
Weight	2,5 kg



	Euro ex. VAT	#Reference
Wheel Set for Bølling Tray Table	40	BBhjul



Note:

Set with 4 wheels.

Arv Cushion
David Thulstrup



	Euro ex. VAT	#Reference
Arv Dining Chair Cushion	120	AVCC
Arv Lounge Chair Cushion	230	AVCC-LO

	Upholstery	# Reference
	Spectrum, Brandy Leather - 30155	66
	Spectrum, Cinnamon Leather - 30146	65



	Euro ex. VAT	#Reference
Beech, Lacquer	395	MOXX-BLA

Dimensions

Height	49 cm
Width	62 cm
Box	64 x 52 x 29 cm
Weight	10 kg

Orbis Tray Table - Rectangular
O&M Studio



	Euro ex. VAT	#Reference
 Stainless Steel, Tempered Glass	2.155	OMS2-CG

Notes:

- Shipped flat packed.
- Must be assembled, tools are included.
- Loose trays.

Dimensions

Length	75 cm
Width	42 cm
Height	80 cm
Box	82 x 50 x 16 cm
Weight	25 kg



	Euro ex. VAT	#Reference
Complete Sample Box	140	KCSB
Leather Sample Set	32	KCLES
Fabric Sample Set	15	KCTS
Wooden Sample (each piece)	8	KCWS
Compact Laminate Set	32	KCLAS
Metal Sample Set	32	KCMS
Webbing Sample Set	8	KCGS

General information



Employees

We employ a variety of people with different backgrounds, education, ethnicity, age and gender.



Education

We employ a large number of trainees and apprentices to support the industry's future.



Union

We follow the collective agreement for the largest trade union in Denmark (3F) to secure workers' rights in the production team.



Safety

Our health and safety regulation are audited on a regular basis by the Danish Working Authority.



Insurance

We offer extra health insurance for our employees and their families.



Wood

We only use certified wood - FSC © or PEFC ©.



Wind Power

Our factory buys electricity from suppliers, where the greatest possible electricity comes from Danish wind farms. This means that we only buy certified Co2 neutral electricity.



Heating

We use waste wood to generate heat - minimizing our carbon footprint.



Local

We prioritize local suppliers to minimize transport emissions.



Packaging

We only use recyclable cardboard and plastic in packaging.



Wood

Wood

We use only certified wood from high quality suppliers. Our craftsmen choose carefully the wood for each piece of furniture. Selected wood sorts for each piece of furniture can be seen under product pages. Please note that all the models are not available in all species.



Natural Oak

North European Oak is mostly straight grained with a medium to coarse texture. It is widely used in Scandinavian furniture because of its strength.



Black Painted Oak

Paint with a semi matt finish. The grains of the oak is still visible. The top coat gives a hard protection and seals the wood.



Fumed Oak

We “home fume” every piece of furniture in our work shop. Every log has different reaction to the fuming so the color varies across each furniture.



Natural Beech

The grain of the natural beech is straight, with a fine to medium uniform texture. It is strong and durable with a good resistance to abrasion.



Oak White Oiled

Light pigments give the grains a brighter tint. It is water-repellent, dirt-resistant and durable.



Waxed Oiled Beech

Wax Oil is developed from natural oils and waxes to provide the most durable protection. It brings out the warmth and depth of the wood.



Waxed Oiled Oak

Wax Oil is developed from natural oils and waxes to provide the most durable protection. It brings out the warmth and depth of the wood.

Wood



White Oiled Ash

Ash will become yellow over time. To prevent this, we use white pigmented wax as a finish.

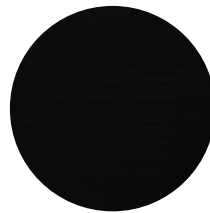

Black Lacquered Ash

The colour and a polyurethane top coat is applied to give a semi matt finish. Lacquered ash is durable and resistant against water, moist and heat.



Red Lacquered Ash

The colour and a polyurethane top coat is applied to give a semi matt finish. Lacquered ash is durable and resistant against water, moist and heat.



Green Lacquered Ash

The colour and a polyurethane top coat is applied to give a semi matt finish. Lacquered ash is durable and resistant against water, moist and heat.



Oiled Walnut

We use an American walnut because of its luxurious dark brown colour and its grain is revealed by a wax oil treatment.



Blue Lacquered Ash

The colour and a polyurethane top coat is applied to give a semi matt finish. Lacquered ash is durable and resistant against water, moist and heat.



Upholstery

Fabric

We create a simple selection of fabrics and leather from the world's best producers considering the quality, sustainability, ethics and safety of their products. All the leathers are chosen carefully from [Sørensen Leather](#) which are originated from European rawhide and fabric from [Kvadrat](#).



Moss by Sahco , 0019
[Kvadrat](#)

Sand
Designed by Vincent van Duysen
and Anna Vilhelmine Ebbesen.
Produced in Belgium.
52% cotton 22% viscose 14%
polyacrylic 6% linen 3% nylon 3%
polyester (worsted), 5% nylon.
50.000 Martindale

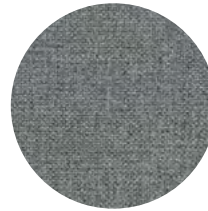

Hallingdal 65, 0113
[Kvadrat](#)

Grey
Designet by Nanna Ditzel
Produced in Norge.
70% wool, 30 % viscose.
100.000 Martindale

Leather

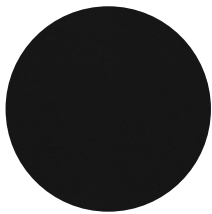

Savanne, 30314
[Sørensen Leather](#)

Black
Aniline Leather
Surface: Natural markings are part of the appeal
Finish Elegant matt with a soft, silky, velvety feel.

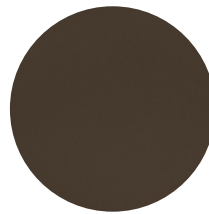

Spectrum, 30146
[Sørensen Leather](#)

Cinnamon
Aniline Leather
Surface: Natural markings are part of the appeal
Finish Elegant matt with a soft, silky, velvety feel.



Spectrum, 30155
[Sørensen Leather](#)

Brandy
Aniline Leather
Surface: Natural markings are part of the appeal
Finish Elegant matt with a soft, silky, velvety feel.

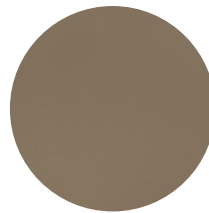

Spectrum, 30150
[Sørensen Leather](#)

Almond
Aniline Leather
Surface: Natural markings are part of the appeal
Finish Elegant matt with a soft, silky, velvety feel.

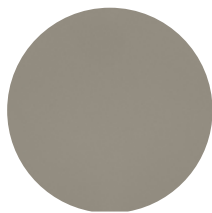

Spectrum, 30157
[Sørensen Leather](#)

Oyster
Aniline Leather
Surface: Natural markings are part of the appeal
Finish Elegant matt with a soft, silky, velvety feel.



Custom Upholstery Solutions

For Custom upholstery options, we charge the same price as the basic model of each product. The customer would be responsible for supplying or paying for the fabric or leather. The measurements are based on following standards:
Fabric with 146 cm, width and 5m² leather skin.

Product	Fabric per piece	Leather per piece
JARI	75 cm	0,8 m ²
ARV	75 cm	0,8 m ²
ARKADE	110 cm	1,3 m ²
PAULINE	45 cm	0,2 m ²
PAULINE COMFORT	45 cm	0,7 m ²
FERDINAND	75 cm	0,8 m ²
KARM Lounge	2 m	X
KARM Sofa 2 seater	4 m	X
KARM Sofa 3 seater	6 m	X

Compact Laminate

Compact laminate is made of special paper compressed into a firm tabletop in the process of high pressure and heat. We only use certified compact laminate of the highest quality, which our craftsmen carefully select for Bølling Tray Table. Each side of the compact laminate has a different colour. Each colour combination is selected to suit all the types of wood we use for Bølling Tray Table.

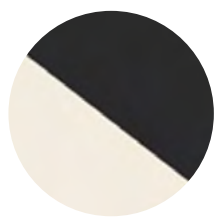

BASE

The classic model with Black and White trays has been discretely adjusted for softer contrast and a bit of warmth.



WATER

A deep marine Blue note that, like an anchor, brings calm and soothing tones to any context. On the reverse side of Water, is a brighter airy Blue, that uplifts with light contrast and tone-in-tone variation.



STONE

Two classic shades of slightly warm Grey, that will compliment most settings. Each side of Stone has its own light and dark grey. In combination they bring subtle and soft contrasts.



SUNNY

The warm Ochre Yellow is a reminiscent of ancient pigment colours, yet with vibrant energy. On the other side of the reversible tray, Sunny has a light creamy tone, that adds contrast and variation.



EARTH

A light caramel Beige that perfectly matches the natural tones of the oakwood frame, and comes across as monochrome, warm and modern. On the other side of the reversible tray, Earth has a dark chocolate Brown.



CLAY

This vibrant burnt Orange has classic notes of terracotta and cognac leather, both complementing and uplifting its interior context. On the other side of the tray, Clays has an off-Black.



LEAF

Two shades of green make up the Leaf colourway. On one side of the tray is a deep dark moss-like Green, and on the other; a lighter olive Green. In combination, the two greens complement each other with soft contrast.



RED

The warm red and black provide a classic contrast and variation that both complementing and uplifting its interior context.



General Terms & Conditions

How to order

Send an e-mail to info@brdr-kruger.dk

- Please write "order" in subject line
- Write amount
- Write Product number as mentioned in the price list
- Write Upholstery Reference as mentioned in the price list
- if applicable.

You will receive an order confirmation (OC) within a few days. Please read carefully.

In the confirmation you will find the date when the product will be finalised. We ship on Thursday and Friday in the week mentioned on the OC.

If you do not want to pick up the goods, please let us know and we can assist with freight.

Delivery time

Average production time is:

Tray tables:	4 weeks
All other furniture:	8-14 weeks

Please ask for updated delivery times.

Currency & Effective Date

This price list is valid from 01.01.2022 and cancels all prior price lists.

Reservation is made for any errors and omissions.

Furthermore, below general terms and conditions shall apply to all contracts under which Brdr. Krüger A/S (Brdr. Krüger) is the supplier/subsupplier.

Order Confirmation

Orders shall not be binding on Brdr. Krüger until the customer has received Brdr. Krüger's written order confirmation.

Order Cancellation

Orders can be cancelled in accordance with the below rules:

Orders cancelled 0-3 days after order confirmation has been sent: no fee

Orders cancelled later than 3 days after order confirmation has been sent: fee: 5% of net price excl. VAT

Delivery

All items are sold ex works: The goods must be collected from Brdr. Krüger's address no later than 20 calendar days after the confirmed shipping date of the complete order. If the goods are not collected according to the above, Brdr. Krüger charge a fee of 20 DKK / 2.5 EURO per. day per packages.

If the customer wants it, Brdr. Krüger can arrange the delivery.

Complaints

The physical product must be inspected upon delivery. Damage incurred in transit as well as any defects and deficiencies on the product incurred as a result of transportation must be recorded on the freight bill upon delivery. Brdr. Krüger must be notified in writing of any complaints about product defects and deficiencies within 24 hours of delivery. If the complaint is made in due time and with the acceptance of Brdr. Krüger, the customer is entitled to demand a replacement delivery or to have the defect remedied. The customer cannot demand a reduction or a compensation. Complaints/replacements can only be made to the customer's address, unless delivery has been made directly to the end consumer.

Terms Of Payment

Unless otherwise agreed, payment must be made before the item is shipped. New customers always pay 14 days before the item is shipped. Customer orders must always be paid upon receipt of OC Brdr. Krüger may decide that the customer must pay in advance if the customer's balance is due, has previously been due or if the order amount exceeds Brdr. Krüger approved credit limit. In the event of non-payment after the deadline, a fee of DKK 150 excluding VAT will be added for the 1st and 2nd reminders. Then interest is calculated at 1.5% per—month from the due date. If there is no payment after the 3rd reminder, the case is transferred to debt collection.

Observation Of Title

Title to the goods shall not pass to the customer until Brdr. Krüger (or any third party to whom Brdr. Krüger has assigned its rights to the purchase price) has received the full purchase price and been reimbursed any expenses incurred.

Limitation Of Liability

Brdr. Krüger will assume no liability for any loss as a result of delays, defects or any other breach of contract, unless such loss was caused by gross negligence on the part of Brdr. Krüger. Brdr. Krüger will assume no liability for any indirect loss, including loss of profits, operating loss, goodwill, loss of customers, running costs or any other consequential economic loss.

Choice Of Law And Jurisdiction

Disputes between Brdr. Krüger and its customers shall be subject to Danish law, except for the international civil law rules of Danish law, and shall be settled by Brdr. Krüger's home court.

Measurements

The stated measurements in this document act only as a guideline. The measurements can vary and size difference on a product can occur.

The commercial warranty applicable to Brdr. Krüger products covers material and manufacturing process defects.

Products are under warranty for a period of 5 years as of the date of invoice sent to the original purchaser. The warranty is granted solely to the original purchaser of the product and is not transferable, either directly or indirectly, to any third party.

In accordance with this warranty, Brdr. Krüger undertakes to repair or replace with a similar product, according to its own criteria and free of charge, any product with any of the defects indicated above, provided that these arise under normal conditions of use.

These conditions are described in our "Care and maintenance" manual.

Exceptions To The Warranty

Upholsteries: Brdr. Krüger products include a variety of collections of upholsteries. Each of them is intended for a specific use and subject to the conditions of guarantee given by the manufacturer of them.

Exclusions To The Warranty

- Natural wear or wear caused by: unsuitable use, excessive scratching/scraping, sliding of objects on the surface, use of abrasive products, placing extremely hot or cold objects on the surface and use for which the product is not intended, on any surface finish and particularly when lacquered, varnished or melamine products are involved.
- Damage caused by mishandling of the products, produced directly or indirectly, as a result of the acts or omission of the Customer/Distributor, be it through fault or neglect. Amongst other things, blows, accidents, inexpert product assembly and installation, dragging products which do not incorporate rolling elements, sitting on tables, etc.
- Leaving the products at unsuitable locations exposed to extreme changes of temperature and/or humidity: in the vicinity of points at which heat or cold are generated, near humidifiers, etc.; and at locations exposed to the open air.
- Defects caused by unsuitable cleaning of the products (wrong methods or products, use of abrasive products), in violation of Brdr. Krüger's recommended guidelines.
- Defects caused by not cleaning or protecting (wood, lacquer, etc.) the products, not removing material or liquids which may immediately damage the surface, etc.
- Damage caused by unsuitable modifications to or operations on the products, or repair work performed by the Customer itself or a third party assigned by it.

- Concerning special orders, products manufactured according to the Customer's specifications and materials provided by the customer for inclusion in the product-manufacturing process, including fabric and upholstery supplied by the Customer are not covered by the warranty.
- Changes in colour, grain and texture due to: the passing of time, exposure to natural light, different batches and/or the natural origin of certain materials, such as wood, leather or natural bres, or, in the event, the artisan origin of certain parts involved in the production process.
- Colour differences of less than Delta-E 1 (in the case of plain colours) compared to the colour chart between different batches in a single delivery.
- Slight variations in the physical appearance of the order compared with the visual representations or descriptions provided by catalogues, samples and display parts, particularly variations in the colour, texture and grain of wood, and in fabrics.
- Typical variations in leather, such as cracks, insect bites or creasing, and variations in the colour or formation of creases due to the elasticity of the leather.
- Marks (from fingers), dirt and shine on dark and/or matt finishes.
- Marks or darker areas caused by failure to suitably protect the contact surface.

Warranty Conditions

It is the Customer's responsibility to check the received product before and during unloading, and to:

- Note any incident on the delivery note: suspicion of faulty packaging and/or product, wrong number of packages, and in this event:
- Take photographs of the load/package/product and make a complaint urgently, providing all relevant information, by email to the email address on the order confirmation request sent to the Customer.

If the Customer detects a non-conformity, then it must proceed to report the fact by email to info@brdr-kruger.dk, including/ attaching:

1. Description of the defect.
2. Photos of the defect, in general and in detail.
3. Clear identification of the product (order number): legible photo of the label, copy of the delivery note, copy of the invoice.

Any claim made which fails to provide the information described will not be accepted by Brdr. Krüger.

In the event of incidents detected during assembly, the Customer must proceed to report the fact, as indicated, within a maximum period of 72 hours. Any claim made after this period will not be accepted by Brdr. Krüger.

Brdr. Krüger reserves the right to request that damaged products be returned before proceeding to replace them. Brdr. Krüger reserves the right to request all necessary information for the analysis of the claim.

Under no circumstance may the replacement of product components or component repair during the warranty period be used to extend the warranty period. Brdr. Krüger's liability is limited to the obligations indicated and to a maximum amount equivalent to the amount for which the customer was invoiced, excluding all types of compensation for indirect immaterial damages or operating losses.

If the parties fail to reach agreement concerning the origin of the damage suffered by the products, their nature or the way in which claims are dealt with financially, liability for damage will be assumed in accordance with the document Economic conditions to apply concerning claims made by the Customer / Distributor, available on our extranet.

Care and Maintenance

The subsequent care instructions are recommendations only. For general surfaces, we recommend using a damp cloth and we recommend that you always use environmentally friendly cleaning products and care for your furniture regularly and frequently. Before using any cleaning product, you should test it on an inconspicuous spot. Please follow the cleaning product manufacturer's instructions.

Fabrics:

To care for fabrics, simply Hoover dust and lint regularly. Stain removal: Fresh stains can usually be removed quickly by wiping immediately with an absorbent, lint-free sponge or cloth. Start from the outer edge of the stain and work towards the centre to avoid creating a halo effect. We recommend using normal household distilled water to prevent limescale residue from building up on dark fabrics after drying. Treatment of persevering stains: Brush dry stains lightly with a soft brush (such as a clothes brush). Depending on the type of stain, the use of solvents may be necessary. In such cases, it is essential to consult a

professional. Under no circumstances should cover fabric surfaces be rubbed vigorously. Please be sure to consult a specialist before using any solvent-based cleaning product.

Leather:

Leather furniture should not be exposed to direct sunlight

and should be kept some distance away from sources of heat; otherwise, the leather can dry out and become rigid. To ensure that leather remains soft and supple and that its natural protective film against water and grease remains intact, we recommend that you treat your furniture once a year with a mild cleaner. Stain removal: Superficial dirt can be removed with a damp cloth as long as care is taken not to wet the leather and not to apply direct pressure. You should also avoid rubbing too hard. For cleaning, we recommend using a special leather cleaner in foam or liquid form. Small dirt stains or pen stains are best removed with a colourless pencil eraser. To prevent the leather from drying out, you should subsequently always apply a designated care product from a specialist retailer. Liquids should be dabbed away immediately with a cloth and, if necessary, wiped off with a little water. Please do not use any aggressive agents such as stain removers, turpentine, shoe polish, etc.

Metal:

Stain removal: For quick removal of contaminants on polished high-shine, matte chrome and aluminium surfaces, apply a glass cleaner with a clean, soft cloth and subsequently wipe the surface dry with a soft cloth. For stainless steel, we recommend using a special stainless steel care spray, steel cleaner or detergent. Powder-coated surfaces should be cleaned with aqueous solutions made from pH-neutral (pH 5-8) detergents or cleaning products and soft, non-abrasive cloths, rags or industrial cotton batting. Always clean metal surfaces gently and without scrubbing so that the surface is not scratched. Never use cleaners containing granular substances, acetic acid or citric acid.

Wood:

Wood is long-lasting, especially when its qualities are properly exploited. Furniture made of wood reacts to its environment; exposure to light, for example, alters its colour. And it is able to adapt its own moisture content levels to that of its environment. In the case of excessive fluctuations in temperature and humidity, however, it reacts by cracking and warping. Brdr. Krüger treats its solid wood tabletops with oil and other treatments to highlight and protect the properties of the natural material. To avoid stains and other damage, liquids should be wiped away immediately. Brdr. Krüger seals its veneers with a high-quality finish. Because of this, a soft, slightly damp cloth – with a mild detergent in the case of stubborn dirt – is sufficient for cleaning solid wood and veneer surfaces. Wet surfaces should be dried immediately with a cloth. Do not use any harsh cleaning agents or care products containing silicone or abrasives. If possible, avoid rubbing

the surface while cleaning it, as this will make matte finishes shiny and charge the varnish with static electricity which will attract more dust. We do not recommend using furniture polish or wax, as they contain unsuitable solvents and/or colour additives and leave a coating that is very difficult to remove.

Laminate And Glass Table Tops:

Clean with a soft cloth tightly wrung out in clean water. For dirty surfaces, use a mild soap flake solution or a mild universal cleaning agent. Then polish with a soft, dry cloth.

Check the goods when you receive it.

Our shipments are sometimes damaged during transport, even though we pack carefully. It is not always possible to check on the packaging whether the product is damaged in shipping.

To cover the transport damage, do the following:

1. While the driver is present: Unpack the items from the packaging and check them for damage before signing the shipment note.

If all goods are damaged, refuse receipt. If only some items are damaged or are slightly damaged, please write on the shipping note that the items are received subject to shipping damage.

2. The driver does not have time to wait: Please note on the consignment note that the goods are received subject to transport damage. Then check the goods and notify us immediately if the shipment is damaged.

It is very important that you immediately check the shipment for damage. You risk losing the right to cover the carrier's damages if not stated on the shipping note.

Brdr. Krüger is not responsible for damages caused during transport. On the other hand, we may hold the carrier responsible if you comply with your obligation to investigate the shipment upon receipt and respond promptly in the event that the shipment is damaged.

It is a good idea to take photos of the damage and of the consignment note, or to have documentation.

Contact Brdr. Krüger at info@brdr-kruger.dk or
Tel: +45 39 56 15 55

Contact Information



SALES DIRECTOR

JYLIANE KRÜGER
Info@brdr-kruger.dk
T: +45 39 56 15 55
M: +45 20 93 09 59

COMMUNICATION AND PRESS

JONAS KRÜGER
Jonas@brdr-kruger.dk
T: +45 39 56 15 55
M: +45 30 25 61 31

FACTORY ADDRESS

BRDR. KRÜGER
Walgerholm 20
DK-3500

SHOWROOM ADDRESS

Bredgade 28
DK-1260

WEBSITE:

www.brdr-kruger.com

