

woggTM

Preisliste

Liste de prix

Price list

WOGG™

Swiss Precision Furniture

Preisliste
Empfohlene Verkaufspreise
Gültig ab 1. Juni 2022

Liste de prix
Prix de vente recommandés
Valable à partir du 1^{er} juin 2022

Price list
Recommended retail prices
Valid from 1 June 2022

Vorwort Préambule Foreword	4
Kollektion Collection Collection	6
Farben & Materialien Couleurs & matériaux Colours & materials	226
Anhang Annexe Appendix	234
Designgeschichte Histoire du design Design history	240
Impressum Impressum Imprint	250

Wir freuen uns, dass Sie unsere neue Preisliste in Händen halten. Auf den nächsten Seiten finden Sie vor allem detaillierte Informationen rund um unsere Produkte und unser Handwerk.

Unsere aktuelle Kollektion macht zeitgemässes Leben besser. Besser bedeutet für uns: Möbel dienen ihrem Zweck, sie sparen Platz, sind aber alles andere als unscheinbar und sie haben das gewisse Etwas. In ihnen konzentriert sich unser neuestes Wissen und jahrelange Erfahrung aus der Zusammenarbeit mit Designern und Werkstoffspezialisten aus Textil-, Holz-, Metall- oder Kunststoffverarbeitung.

Wir laden Sie ein, die Wogg-Welt zu entdecken. Alle Möbel fügen sich nicht nur flexibel in Räume ein. In Aussehen und Nutzen sind sie einzigartig, weil von uns entwickelte technische Lösungen neue Formen und echten Komfort möglich machen.

Willi Glaeser (CEO)
Christophe Marchand (Creative Director)

C'est un grand plaisir pour nous que de savoir notre liste de prix entre vos mains. Vous trouverez dans les pages qui suivent des informations détaillées concernant l'ensemble de nos produits et de notre métier.

Notre nouvelle collection se donne pour objectif l'amélioration de la vie moderne. Car pour nous, une vie meilleure est synonyme de meubles qui remplissent leur fonction, permettent de gagner de la place – sans être le moins du monde invisibles – et font montre d'une forte personnalité. Ils sont un concentré de nos toutes dernières solutions, fruits d'une longue expérience dans la collaboration entre designers et spécialistes dans le travail du textile, du bois, du métal et du plastique.

Nous vous invitons à découvrir le monde de WOOG. Non seulement l'ensemble de nos meubles s'insèrent dans l'espace avec une grande flexibilité, mais ils sont également uniques en leur genre sur les plans esthétique et fonctionnel – et ce, grâce à nos solutions techniques qui leur confèrent des formes inédites tout en assurant le plus grand confort.

Willi Glaeser (CEO)
Christophe Marchand (Creative Director)

We are thrilled that you are holding our new price list in your hands. On the following pages, you will find all sorts of detailed information about our products and our craftsmanship.

Our current collection makes contemporary living better. And by better we mean: we make furniture that serves its purpose and saves space, yet is anything but nondescript; furniture that has that special something. Our up-to-date knowledge and years of experience collaborating with designers and materials experts from textile, wood, metal or plastics production go into every piece of our new collection.

We are inviting you to discover the world of Wogg. Our furniture not only blends well into virtually any kind of space: each piece has its own unique appearance and function. We engineer technological solutions that make new forms and true comfort possible.

Willi Glaeser (CEO)
Christophe Marchand (Creative Director)

wogg 18
Design:
Benny Mosimann

Classicboard
8
10
12

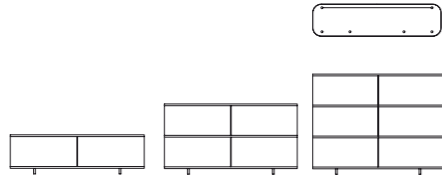

wogg 44
Design:
Benny Mosimann

Longboard
22

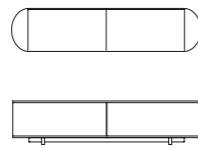

wogg 17
Design:
Benny Mosimann

Ellipsetower
30
32
34

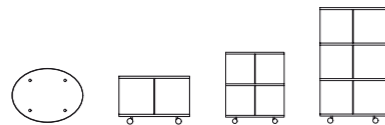

wogg 67
Design:
Benny Mosimann

Ellipsetower wood
44
46
48

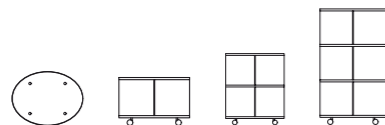

wogg 73
Design:
Benny Mosimann

Cylinder D40
56

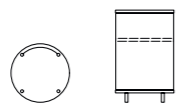

wogg 74
Design:
Benny Mosimann

Cylinder D50
66
72
78

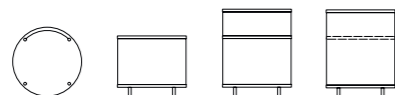

wogg 13
Design:
Hans Eichenberger

Pillar box tray
92
Pillar box display
100
Pillar box drawer (2)
108
Pillar box drawer (4)
116

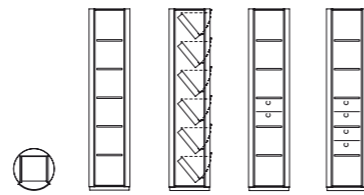

wogg 80
Hommage to
Hans Eichenberger

Pillar box small tray
128
Pillar box small display
136

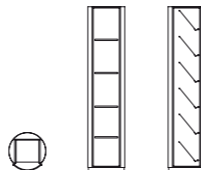

wogg 79
Design:
Christophe Marchand

Wardrobe
146
Cupboard
150

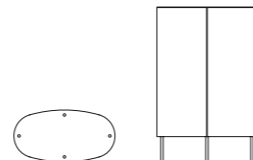

wogg 81
Design:
Christophe Marchand

Bigboard high
156

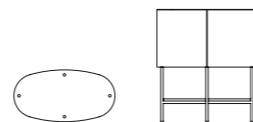

wogg 82
Design:
Christophe Marchand

Sideboard
162

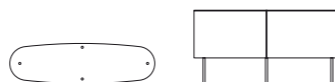

wogg 83
Design:
Christophe Marchand

Bar
168



wogg 84
Design:
Christophe Marchand

Smallboard
174



wogg 25
Design:
Christophe Marchand

Shelf tower
180

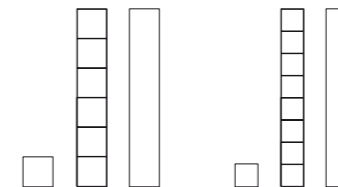

wogg 52
Design:
Christophe Marchand

Shelf box
182

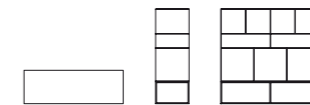

wogg 70
Design:
Matthieu Girel

Shelf system H2
186
Shelf system H4
190



wogg 38
Design:
Alfredo Häberli

Table
196

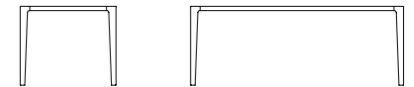

wogg 54
Design:
Christophe Marchand

Desk small
200
Desk big
202

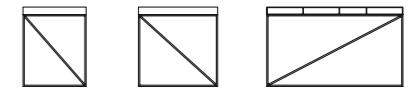

wogg 72
Design:
Christophe Marchand

Lounger textile
206
Lounger leather
216

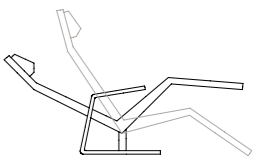



Design:
Benny Mosimann
1997

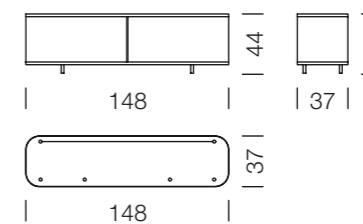

Masse in cm
Dimensions en cm
Dimensions in cm



Bestell-Nr. N° de commande Reference no.	Ausführung, Farbe & Material	Finition, matériau & couleur
	Boden: Melamin seidenmatt schwarz aProfile: Aluminium schwarz eloxiert Rückwand: Melamin seidenmatt schwarz Füße: Aluminium schwarz lackiert Fusshöhe: 6.5 cm	Base: mélamine noire satinée Portes coulissantes: plastique (PP) noir Profilé: aluminium anodisé noir Panneau arrière: mélamine noire satinée Pieds: aluminium laqué noir Hauteur du pied: 6.5 cm
18-001-221-221-071-014	Abdeckung: Melamin seidenmatt schwarz	Dessus: mélamine noire satinée
18-001-221-571-071-014	Abdeckung: Klarglas schwarz unterlackiert	Dessus: verre transparent au dessous laqué noir
	Boden: Melamin seidenmatt weiss Schieber: Kunststoff (PP) opalweiss Profile: Aluminium natur eloxiert Rückwand: Melamin seidenmatt weiss Füße: Aluminium natur lackiert Fusshöhe: 6.5 cm	Base: mélamine blanche satinée Portes coulissantes: plastique (PP) blanc opalin Profilé: aluminium anodisé naturel Panneau arrière: mélamine blanche satinée Pieds: aluminium laqué naturel Hauteur du pied: 6.5 cm
18-001-229-229-056-013	Abdeckung: Melamin seidenmatt weiss	Dessus: mélamine blanche satinée
18-001-229-561-056-013	Abdeckung: Klarglas weiss unterlackiert	Dessus: verre transparent au dessous laqué blanc

Finish, material & colour	Verpackungsmasse Dimensions de l'emballage Package dimensions	Gewicht Poids Weight	CHF	EUR
Base: melamine, silky matt black Sliding doors: plastic (PP), black Profiles: aluminium, black anodized Back wall: melamine, silky matt black Feet: aluminium, black lacquered Foot height: 6.5 cm	→ 158 cm ↗ 47 cm ↑ 50 cm			
Cover: melamine, silky matt black		27 kg	1699.-	1619.-
Cover: clear glass, black-lacquered underside		33 kg	1899.-	1809.-
Base: melamine, silky matt white Sliding doors: plastic (PP), opal white Profiles: aluminium, natural anodized Back wall: melamine, silky matt white Feet: aluminium, natural lacquered Foot height: 6.5 cm	→ 158 cm ↗ 47 cm ↑ 50 cm			
Cover: melamine, silky matt white		27 kg	1499.-	1429.-
Cover: clear glass, white-lacquered underside		33 kg	1699.-	1619.-



Preise: UVP exkl. MwSt.
 Prix: prix de vente
 conseillés hors TVA
 Prices: RRP ex. VAT

Design:
Benny Mosimann
1997

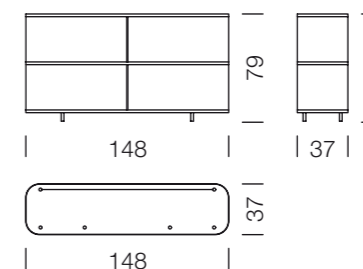

Masse in cm
Dimensions en cm
Dimensions in cm



Bestell-Nr. N° de commande Reference no.	Ausführung, Farbe & Material	Finition, matériau & couleur
	Boden: Melamin seidenmatt schwarz Schieber: Kunststoff (PP) schwarz Profil: Aluminium schwarz eloxiert Rückwand: Melamin seidenmatt schwarz Füsse: Aluminium schwarz lackiert Fusshöhe: 6.5 cm	Base: mélamine noire satinée Portes coulissantes: plastique (PP) noir Profilé: aluminium anodisé noir Panneau arrière: mélamine noire satinée Pieds: aluminium laqué noir Hauteur du pied: 6.5 cm
18-002-221-221-071-014	Abdeckung: Melamin seidenmatt schwarz	Dessus: mélamine noire satinée
18-002-221-571-071-014	Abdeckung: Klarglas schwarz unterlackiert	Dessus: verre transparent au dessous laqué noir
	Boden: Melamin seidenmatt weiss Schieber: Kunststoff (PP) opalweiss Profil: Aluminium natur eloxiert Rückwand: Melamin seidenmatt weiss Füsse: Aluminium natur lackiert Fusshöhe: 6.5 cm	Base: mélamine blanche satinée Portes coulissantes: plastique (PP) blanc opalin Profilé: aluminium anodisé naturel Panneau arrière: mélamine blanche satinée Pieds: aluminium laqué naturel Hauteur du pied: 6.5 cm
18-002-229-229-056-013	Abdeckung: Melamin seidenmatt weiss	Dessus: mélamine blanche satinée
18-002-229-561-056-013	Abdeckung: Klarglas weiss unterlackiert	Dessus: verre transparent au dessous laqué blanc

Finish, material & colour	Verpackungsmasse Dimensions de l'emballage Package dimensions	Gewicht Poids Weight	CHF	EUR
Base: melamine, silky matt black Sliding doors: plastic (PP), black Profiles: aluminium, black anodized Back wall: melamine, silky matt black Feet: aluminium, black lacquered Foot height: 6.5 cm	→ 158 cm ↗ 47 cm ↑ 84 cm	41 kg	2499.-	2389.-
Cover: melamine, silky matt black Cover: clear glass, black-lacquered underside		45 kg	2699.-	2579.-
Base: melamine, silky matt white Sliding doors: plastic (PP), opal white Profiles: aluminium, natural anodized Back wall: melamine, silky matt white Feet: aluminium, natural lacquered Foot height: 6.5 cm	→ 158 cm ↗ 47 cm ↑ 84 cm	41 kg	2499.-	2389.-
Cover: melamine, silky matt white Cover: clear glass, white-lacquered underside		45 kg	2699.-	2579.-



Preise: UVP exkl. MwSt.
 Prix: prix de vente
 conseillés hors TVA
 Prices: RRP ex. VAT

Design:
Benny Mosimann
1997



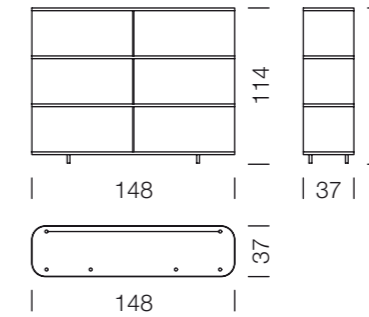



Masse in cm
Dimensions en cm
Dimensions in cm





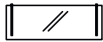
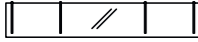

Bestell-Nr. N° de commande Reference no.	Ausführung, Farbe & Material	Finition, matériau & couleur
	Boden: Melamin seidenmatt schwarz Schieber: Kunststoff (PP) schwarz Profil: Aluminium schwarz eloxiert Rückwand: Melamin seidenmatt schwarz Füsse: Aluminium schwarz lackiert Fusshöhe: 6.5 cm	Base: mélamine noire satinée Portes coulissantes: plastique (PP) noir Profilé: aluminium anodisé noir Panneau arrière: mélamine noire satinée Pieds: aluminium laqué noir Hauteur du pied: 6.5 cm
18-003-221-221-071-014	Abdeckung: Melamin seidenmatt schwarz	Dessus: mélamine noire satinée
18-003-221-571-071-014	Abdeckung: Klarglas schwarz unterlackiert	Dessus: verre transparent au dessous laqué noir
	Boden: Melamin seidenmatt weiss Schieber: Kunststoff (PP) opalweiss Profil: Aluminium natur eloxiert Rückwand: Melamin seidenmatt weiss Füsse: Aluminium natur lackiert Fusshöhe: 6.5 cm	Base: mélamine blanche satinée Portes coulissantes: plastique (PP) blanc opalin Profilé: aluminium anodisé naturel Panneau arrière: mélamine blanche satinée Pieds: aluminium laqué naturel Hauteur du pied: 6.5 cm
18-003-229-229-056-013	Abdeckung: Melamin seidenmatt weiss	Dessus: mélamine blanche satinée
18-003-229-561-056-013	Abdeckung: Klarglas weiss unterlackiert	Dessus: verre transparent au dessous laqué blanc

Finish, material & colour	Verpackungsmasse Dimensions de l'emballage Package dimensions	Gewicht Poids Weight	CHF	EUR
Base: melamine, silky matt black Sliding doors: plastic (PP), black Profiles: aluminium, black anodized Back wall: melamine, silky matt black Feet: aluminium, black lacquered Foot height: 6.5 cm	→ 158 cm ↗ 47 cm ↑ 121 cm			
Cover: melamine, silky matt black		58 kg	3199.-	3049.-
Cover: clear glass, black-lacquered underside		62 kg	3399.-	3239.-
Base: melamine, silky matt white Sliding doors: plastic (PP), opal white Profiles: aluminium, natural anodized Back wall: melamine, silky matt white Feet: aluminium, natural lacquered Foot height: 6.5 cm	→ 158 cm ↗ 47 cm ↑ 121 cm			
Cover: melamine, silky matt white		58 kg	3199.-	3049.-
Cover: clear glass, white-lacquered underside		62 kg	3399.-	3239.-

Preise: UVP exkl. MwSt.
 Prix: prix de vente
 conseillés hors TVA
 Prices: RRP ex. VAT

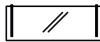
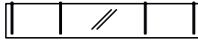

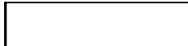



Bestell-Nr. N° de commande Reference no.	Zubehör	Accessoires
	Glastablar mittig, Tablar: Klarglas Grösse: 70.5 x 25 cm h= 0.8 cm Tablarträger: 2 höhenverstellbare Konsolen Acryl (Raster: 4 cm)	Étagère du milieu en verre, étagère: verre transparent Dimensions: 70.5 x 25 cm h= 0.8 cm Supports d'étagère: 2 consoles en acrylique réglables en hauteur (pas: 4 cm)
18-011-551-051		
	Glastablar über ganze Länge, Tablar: Klarglas Grösse: 142 x 25 cm h= 0.8 cm Tablarträger: 4 höhenverstellbare Konsolen Acryl (Raster: 4 cm)	Étagère en verre de longueur complète, étagère: verre transparent; Dimensions: 142 x 25 cm h= 0.8 cm; Supports d'étagère: 4 consoles en acrylique réglables en hauteur (pas: 4 cm)
18-013-551-051		
	Kabeldurchführung schwarz, Farbe: Kunststoff schwarz Durchmesser: 7 cm, Innendurchmesser: 5.5 cm Positionierung: hinten mittig Wahlweise in Deckel / Boden / Abdeckung aus Melamin	Passage de câbles, couleur: plastique noir Diamètre: 7 cm, diamètre intérieur: 5.5 cm Positionnement: arrière au milieu Au choix dans plateau/base/dessus en mélamine
18-012-062		
	Kabeldurchführung weiss, Farbe: Kunststoff weiss Durchmesser: 7 cm, Innendurchmesser: 5.5 cm Positionierung: hinten mittig Wahlweise in Deckel / Boden / Abdeckung aus Melamin	Passage de câbles, couleur: plastique blanc Diamètre: 7 cm, diamètre intérieur: 5.5 cm Positionnement: arrière au milieu Au choix dans plateau/base/dessus en mélamine
18-012-061		
	Glasabdeckplatte, Klarglas schwarz unterlackiert Inkl. Klebeband zum auflegen und aufkleben, auf bestehenden Deckel (aus Melamin)	Plaque de dessus en verre, verre transparent au dessous laqué noir, avec bande adhésive à poser et à coller sur dessus d'origine (en mélamine)
18-030-571		
	Glasabdeckplatte, Klarglas weiss unterlackiert Inkl. Klebeband zum auflegen und aufkleben, auf den bestehenden Deckel (aus Melamin)	Plaque de dessus en verre, verre transparent au dessous laqué blanc, avec bande adhésive à poser et à coller sur dessus d'origine (en mélamine)
18-030-561		

Accessories	Verpackungsmasse Dimensions de l'emballage Package dimensions	Gewicht Poids Weight	CHF	EUR
Glass shelf, centred; Shelf: clear glass Dimensions: 70.5 x 25 cm h= 0.8 cm Shelf supports: 2 height-adjustable acrylic brackets (in 4 cm increments)	→ 75 cm ↗ 29 cm ↑ 3 cm	2 kg	329.-	319.-
Glass shelf, full length; Shelf: clear glass Dimensions: 142 x 25 cm h= 0.8 cm Shelf supports: 4 height-adjustable acrylic brackets (in 4 cm increments)	→ 146 cm ↗ 29 cm ↑ 3 cm	5 kg	499.-	1749.-
Cable grommet, Colour: plastic, black Diameter: 7 cm, Inner diameter: 5.5 cm Positioning: centre back Optional lid / base / cover made of melamine			49.-	49.-
Cable grommet, Colour: plastic, white Diameter: 7 cm, Inner diameter: 5.5 cm Positioning: centre back Optional lid / base / cover made of melamine			49.-	49.-
Glass cover plate; clear glass, black-lacquered underside Incl. adhesive tape to place and affix existing lid (made of melamine)	→ 158 cm ↗ 47 cm ↑ 4 cm	10 kg	449.-	429.-
Glass cover plate; clear glass, white-lacquered underside Incl. adhesive tape to place and affix existing lid (made of melamine)	→ 158 cm ↗ 47 cm ↑ 4 cm	10 kg	449.-	429.-

Bestell-Nr. N° de commande Reference no.	Ersatzteile	Pièces de rechange
	Ersatztablarträger Höhenverstellbare Konsolen Acryl (Raster: 4 cm) 2 Stück	Supports d'étagère de rechange Consoles en acrylique réglables en hauteur (pas: 4 cm) 2 pièces
18-011-051		
	Ersatzglastablar mittig Tablar: Klarglas Grösse: 70.5 x 25 cm h= 0.8 cm	Étagère en verre du milieu de rechange Étagère: verre transparent Dimensions: 70.5 x 25 cm h= 0.8 cm
18-011-551		
	Ersatzglastablar über ganze Länge Tablar: Klarglas Grösse: 142 x 25 cm h= 0.8 cm	Étagère en verre de longueur complète, de rechange Étagère: verre transparent Dimensions: 142 x 25 cm h= 0.8 cm
18-013-551		
	Ersatzschieber, 2 Stück Farbe: Kunststoff (PP) schwarz Grösse: 113.4 x 33.9 cm Profil: Aluminium natur eloxiert	Portes coulissantes de rechange, 2 pièces Couleur: plastique (PP) noir Dimensions: 113.4 x 33.9 cm Profilé: aluminium anodisé naturel
18-020-071-013		
	Ersatzschieber, 2 Stück Farbe: Kunststoff (PP) schwarz Grösse: 113.4 x 33.9 cm Profil: Aluminium schwarz eloxiert	Portes coulissantes de rechange, 2 pièces Couleur: plastique (PP) noir Dimensions: 113.4 x 33.9 cm Profilé: aluminium anodisé noir
18-020-071-014		
	Ersatzschieber, 2 Stück Farbe: Kunststoff (PP) opalweiss Grösse: 113.4 x 33.9 cm Profil: Aluminium natur eloxiert	Portes coulissantes de rechange, 2 pièces Couleur: plastique (PP) blanc opalin Dimensions: 113.4 x 33.9 cm Profilé: aluminium anodisé naturel
18-020-056-013		
	Ersatzrückwand Grösse: 124.5 x 34 cm Melamin seidenmatt schwarz	Panneau arrière de rechange Dimensions: 124.5 x 34 cm Mélamine noire satinée
18-021-221		

Spare parts	Verpackungsmasse Dimensions de l'emballage Package dimensions	Gewicht Poids Weight	CHF	EUR
Replacement tray supports Height-adjustable acrylic brackets (in 4 cm increments) 2 pieces	→ 40 cm ↗ 20 cm ↑ 20 cm	1 kg	189.-	189.-
Replacement glass shelf, centred Shelf: clear glass Dimensions: 70.5 x 25 cm h= 0.8 cm	→ 75 cm ↗ 29 cm ↑ 3 cm	2 kg	179.-	179.-
Replacement glass shelf, full length Shelf: clear glass Dimensions: 142 x 25 cm h= 0.8 cm	→ 146 cm ↗ 29 cm ↑ 3 cm	5 kg	239.-	229.-
Replacement sliding doors, 2 pieces Colour: plastic (PP), black Dimensions: 113.4 x 33.9 cm Profiles: aluminium, natural anodized	→ 40 cm ↗ 40 cm ↑ 40 cm	2 kg	339.-	329.-
Replacement sliding doors, 2 pieces Colour: plastic (PP), black Dimensions: 113.4 x 33.9 cm Profiles: aluminium, black anodized	→ 40 cm ↗ 40 cm ↑ 40 cm	2 kg	339.-	329.-
Replacement sliding doors, 2 pieces Colour: plastic (PP), opal white Dimensions: 113.4 x 33.9 cm Profiles: aluminium, natural anodized	→ 40 cm ↗ 40 cm ↑ 40 cm	2 kg	339.-	329.-
Replacement back wall Dimensions: 124.5 x 34 cm Melamine, silky matt black	→ 130 cm ↗ 40 cm ↑ 3 cm	5 kg	169.-	169.-

Preise: UVP exkl. MwSt.
Prix: prix de vente
conseillés hors TVA
Prices: RRP ex. VAT

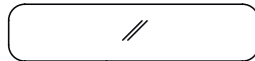
Bestell-Nr. N° de commande Reference no.	Ersatzteile	Pièces de rechange
	Ersatzrückwand Grösse: 124.5 x 34 cm Melamin seidenmatt weiss	Panneau arrière de rechange Dimensions: 124.5 x 34 cm Mélamine blanche satinée
18-021-229		
	Ersatzfuss Aluminium schwarz eloxiert Fusshöhe: 6.5 cm	Pied de rechange Aluminium anodisé noir Hauteur du pied: 6.5 cm
18-022-014		
	Ersatzfuss Aluminium natur eloxiert Fusshöhe: 6.5 cm	Pied de rechange Aluminium anodisé naturel Hauteur du pied: 6.5 cm
18-022-013		
	Ersatzabdeckung Abdeckung: Melamin seidenmatt schwarz Profil: Aluminium natur eloxiert	Dessus de rechange Dessus: mélamine noire satinée Profilé: aluminium anodisé naturel
18-040-221-013		
	Ersatzabdeckung Abdeckung: Melamin seidenmatt schwarz Profil: Aluminium schwarz eloxiert	Dessus de rechange Dessus: mélamine noire satinée Profilé: aluminium anodisé noir
18-040-221-014		
	Ersatzabdeckung Abdeckung: Melamin seidenmatt weiss Profil: Aluminium natur eloxiert	Dessus de rechange Dessus: mélamine blanche satinée Profilé: aluminium anodisé naturel
18-040-229-013		
	Ersatzglasabdeckung Abdeckung: Klarglas schwarz unterlackiert Profil: Aluminium natur eloxiert	Dessus en verre de rechange Dessus: verre transparent au dessous laqué noir Profilé: aluminium anodisé naturel
18-040-571-013		

Spare parts	Verpackungsmasse Dimensions de l'emballage Package dimensions	Gewicht Poids Weight	CHF	EUR
Replacement back wall Dimensions: 124.5 x 34 cm Melamine, silky matt white	→ 130 cm ↗ 40 cm ↑ 3 cm			
		5 kg	169.-	169.-
Replacement foot Aluminium, black anodized Foot height: 6.5 cm	→ 20 cm ↗ 20 cm ↑ 5 cm			
		1 kg	29.-	29.-
Replacement foot Aluminium, natural anodized Foot height: 6.5 cm	→ 20 cm ↗ 20 cm ↑ 5 cm			
		1 kg	29.-	29.-
Replacement cover Cover: melamine, silky matt black Profiles: aluminium, natural anodized	→ 158 cm ↗ 47 cm ↑ 4 cm			
		10 kg	339.-	329.-
Replacement cover Cover: melamine, silky matt black Profiles: aluminium, black anodized	→ 158 cm ↗ 47 cm ↑ 4 cm			
		10 kg	339.-	329.-
Replacement cover Cover: melamine, silky matt white Profiles: aluminium, natural anodized	→ 158 cm ↗ 47 cm ↑ 4 cm			
		10 kg	339.-	329.-
Replacement glass cover Cover: clear glass, black-lacquered underside Profiles: aluminium, natural anodized	→ 158 cm ↗ 47 cm ↑ 4 cm			
		20 kg	799.-	769.-

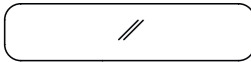
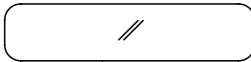
Bestell-Nr. N° de commande Reference no.	Ersatzteile	Pièces de rechange
	 Ersatzglasabdeckung Abdeckung: Klarglas schwarz unterlackiert Profil: Aluminium schwarz eloxiert	Dessus en verre de rechange Dessus: verre transparent au dessous laqué noir Profilé: aluminium anodisé noir
18-040-571-014		
	 Ersatzglasabdeckung Abdeckung: Klarglas weiss unterlackiert Profil: Aluminium natur eloxiert	Dessus en verre de rechange Dessus: verre transparent au dessous laqué blanc Profilé: aluminium anodisé naturel
18-040-561-013		



Spare parts	Verpackungsmasse Dimensions de l'emballage Package dimensions	Gewicht Poids Weight	CHF	EUR
Replacement glass cover Cover: clear glass, black-lacquered underside Profiles: aluminium, black anodized	→ 158 cm ↗ 47 cm ↑ 4 cm			
		20 kg	799.-	769.-
Replacement glass cover Cover: clear glass, white-lacquered underside Profiles: aluminium, natural anodized	→ 158 cm ↗ 47 cm ↑ 4 cm			
		20 kg	799.-	769.-

Design:
Benny Mosimann
2007



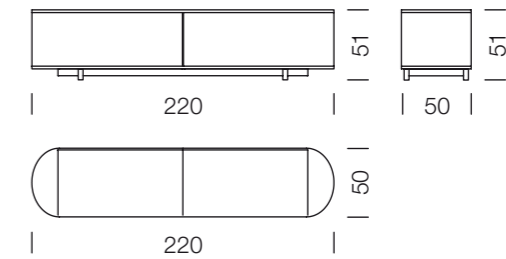

Masse in cm
Dimensions en cm
Dimensions in cm



Bestell-Nr. N° de commande Reference no.	Ausführung, Farbe & Material	Finition, matériau & couleur
	<p>Basis / Zwischenwände: Melamin seidenmatt schwarz Boden: Melamin seidenmatt schwarz Schieber: Kunststoff (PP) schwarz Profil: Aluminium schwarz eloxiert Rückwand: Melamin seidenmatt schwarz Untergestell: schwarz lackiert, nivellierbar Gestellhöhe: 8 cm</p>	<p>Base / cloisons de séparation: mélamine noire satinée Base: mélamine noire satinée Portes coulissantes: plastique (PP) noir Profilé: aluminium anodisé noir Panneau arrière: mélamine noire satinée Piètement: aluminium laqué noir, ajustable Hauteur du piètement: 8 cm</p>
44-001-221-221-071-014	Abdeckung: Melamin seidenmatt schwarz	Dessus: mélamine noire satinée
44-001-221-561-071-014	Abdeckung: Klarglas schwarz unterlackiert	Dessus: verre transparent au dessous laqué noir
	<p>Basis / Zwischenwände: Melamin seidenmatt weiss Boden: Melamin seidenmatt weiss Schieber: Kunststoff (PP) opalweiss Profil: Aluminium natur eloxiert Rückwand: Melamin seidenmatt weiss Untergestell: Aluminium natur lackiert, nivellierbar Gestellhöhe: 8 cm</p>	<p>Base / cloisons de séparation: mélamine blanche satinée Base: mélamine blanche satinée Portes coulissantes: plastique (PP) blanc opalin Profilé: aluminium anodisé naturel Panneau arrière: mélamine blanche satinée Piètement: aluminium laqué naturel, ajustable Hauteur du piètement: 8 cm</p>
44-001-229-229-056-013	Abdeckung: Melamin seidenmatt weiss	Dessus: mélamine blanche satinée
44-001-229-571-056-013	Abdeckung: Klarglas weiss unterlackiert	Dessus: verre transparent au dessous laqué blanc

Finish, material & colour	Verpackungsmasse Dimensions de l'emballage Package dimensions	Gewicht Poids Weight	CHF	EUR
<p>Base / partition walls: melamine, silky matt black Base: melamine, silky matt black Sliding doors: plastic (PP), black Profiles: aluminium, black anodized Back wall: melamine, silky matt black Base frame: aluminium, black lacquered, height adjustable Frame height: 8 cm</p>	<p>→ 230 cm ↗ 60 cm ↑ 56 cm</p>			
Cover: melamine, silky matt black		68 kg	3999.-	3809.-
Cover: clear glass, black-lacquered underside		75 kg	4399.-	4189.-
<p>Base / partition walls: melamine, silky matt white Base: melamine, silky matt white Sliding doors: plastic (PP), opal white Profiles: aluminium, natural anodized Back wall: melamine, silky matt white Base frame: aluminium, natural lacquered, height adjustable Frame height: 8 cm</p>	<p>→ 230 cm ↗ 60 cm ↑ 56 cm</p>			
Cover: melamine, silky matt white		68 kg	3999.-	3809.-
Cover: clear glass, white-lacquered underside		75 kg	4399.-	4189.-

Preise: UVP exkl. MwSt.
Prix: prix de vente
conseillés hors TVA
Prices: RRP ex. VAT

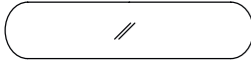
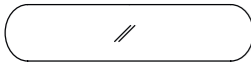
Bestell-Nr. N° de commande Reference no.	Zubehör	Accessoires
	Glastablar links/rechts, Tablar: Klarglas Grösse: 88 x 42 cm h= 0.8 cm Tablarträger: höhenverstellbar (Raster: 3.5 cm)	Étagère en verre gauche/droite, étagère: verre transparent Dimensions: 88 x 42 cm h= 0.8 cm Supports: réglables en hauteur (pas: 3.5 cm)
44-011-551		
	Kabeldurchführung, Farbe: Kunststoff schwarz Durchmesser: 7 cm, Innendurchmesser: 5.5 cm Positionierung: hinten mittig links u/o rechts Wahlweise in Boden u/o Abdeckung aus Melamin	Passage de câbles, couleur: plastique noir Diamètre: 7 cm, diamètre intérieur: 5.5 cm Positionnement: arrière central gauche et/ou droite Au choix dans plateau/base/dessus en mélamine
44-012-062		
	Kabeldurchführung, Farbe: Kunststoff opalweiss Durchmesser: 7 cm, Innendurchmesser: 5.5 cm Positionierung: hinten mittig links u/o rechts Wahlweise in Boden u/o Abdeckung aus Melamin	Passage de câbles, couleur: plastique blanc opalin Diamètre: 7 cm, diamètre intérieur: 5.5 cm Positionnement: arrière central gauche et/ou droite Au choix dans plateau/base/dessus en mélamine
44-012-061		
	Glasabdeckplatte, Klarglas schwarz unterlackiert Inkl. Klebeband zum auflegen und aufkleben, auf bestehenden Deckel (aus Melamin)	Plaque de dessus en verre, verre transparent au dessous laqué noir Avec bande adhésive à poser et à coller sur dessus d'origine (en mélamine)
44-030-571		
	Glasabdeckplatte, Klarglas weiss unterlackiert Inkl. Klebeband zum auflegen und aufkleben, auf den bestehenden Deckel (aus Melamin)	Plaque de dessus en verre, verre transparent au dessous laqué blanc Avec bande adhésive à poser et à coller sur dessus d'origine (en mélamine)
44-030-561		

Accessories	Verpackungsmasse Dimensions de l'emballage Package dimensions	Gewicht Poids Weight	CHF	EUR
Glass shelf, left/right, Shelf: clear glass Dimensions: 88 x 42 cm h= 0.8 cm Supports: height adjustable (in 3.5 cm increments)	→ 91 cm ↗ 45 cm ↑ 3 cm	7 kg	199.-	189.-
Cable grommet, Colour: plastic, black Diameter: 7 cm, Inner diameter: 5.5 cm Positioning: centre back left and/or right Optional lid / base / cover made of melamine			49.-	49.-
Cable grommet, Colour: plastic opal white Diameter: 7 cm, Inner diameter: 5.5 cm Positioning: centre back left and/or right Optional lid / base / cover made of melamine			49.-	49.-
Glass cover plate, Clear glass, black-lacquered underside Incl. adhesive tape to place and stick on existing lid (made of melamine)	→ 230 cm ↗ 60 cm ↑ 4 cm	20 kg	539.-	519.-
Glass cover plate, Clear glass, white-lacquered underside Incl. adhesive tape to place and stick on existing lid (made of melamine)	→ 230 cm ↗ 60 cm ↑ 4 cm	20 kg	539.-	519.-

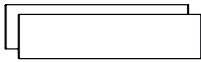
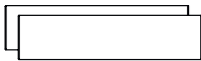
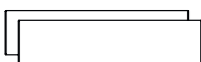
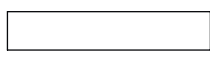
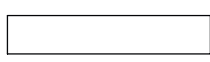
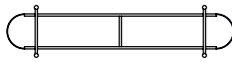
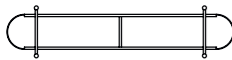
Bestell-Nr. N° de commande Reference no.	Ersatzteile	Pièces de rechange
	Ersatzschieber, 2 Stück Farbe: Kunststoff (PP) schwarz Grösse: 161 x 39.2 cm Profil: Aluminium natur eloxiert	Portes coulissantes de rechange, 2 pièces Couleur: plastique (PP) noir Dimensions: 161 x 39.2 cm Profilé: aluminium anodisé naturel
44-020-071-013		
	Ersatzschieber, 2 Stück Farbe: Kunststoff (PP) schwarz Grösse: 161 x 39.2 cm Profil: Aluminium schwarz eloxiert	Portes coulissantes de rechange, 2 pièces Couleur: plastique (PP) noir Dimensions: 161 x 39.2 cm Profilé: aluminium anodisé noir
44-020-071-014		
	Ersatzschieber, 2 Stück Farbe: Kunststoff (PP) opalweiss Grösse: 161 x 39.2 cm Profil: Aluminium natur eloxiert	Portes coulissantes de rechange, 2 pièces Couleur: plastique (PP) blanc opalin Dimensions: 161 x 39.2 cm Profilé: aluminium anodisé naturel
44-020-056-013		
	Ersatzrückwand Grösse: 179 x 40 cm Melamin weiss seidenmatt	Panneau arrière de rechange Dimensions: 179 x 40 cm Mélamine noire satinée
44-021-221		
	Ersatzrückwand Grösse: 179 x 40 cm Melamin schwarz seidenmatt	Panneau arrière de rechange Dimensions: 179 x 40 cm Mélamine blanche satinée
44-021-229		
	Ersatzuntergestell Schwarz lackiert, nivellierbar Gestellhöhe: 8 cm	Piètement de remplacement Aluminium laqué noir, ajustable Hauteur du piètement: 8 cm
44-022-114		
	Ersatzuntergestell Aluminium natur lackiert, nivellierbar Gestellhöhe: 8 cm	Piètement de remplacement Aluminium laqué naturel, ajustable Hauteur du piètement: 8 cm
44-022-113		

Spare parts	Verpackungsmasse Dimensions de l'emballage Package dimensions	Gewicht Poids Weight	CHF	EUR
Replacement sliding doors, 2 pieces Colour: plastic (PP), black Dimensions: 161 x 39.2 cm Profiles: aluminium, natural anodized	→ 40 cm ↗ 40 cm ↑ 40 cm	2 kg	399.-	389.-
Replacement sliding doors, 2 pieces Colour: plastic (PP), black Dimensions: 161 x 39.2 cm Profiles: aluminium, black anodized	→ 40 cm ↗ 40 cm ↑ 40 cm	2 kg	399.-	389.-
Replacement sliding doors, 2 pieces Colour: plastic (PP), opal white Dimensions: 161 x 39.2 cm Profiles: aluminium, natural anodized	→ 40 cm ↗ 40 cm ↑ 40 cm	2 kg	399.-	389.-
Replacement back wall Dimensions: 179 x 40 cm Melamine, silky matt black	→ 185 cm ↗ 45 cm ↑ 3 cm	8 kg	239.-	229.-
Replacement back wall Dimensions: 179 x 40 cm Melamine, silky matt white	→ 185 cm ↗ 45 cm ↑ 3 cm	8 kg	239.-	229.-
Replacement base frame Aluminium, black lacquered, height adjustable Frame height: 8 cm	→ 210 cm ↗ 52 cm ↑ 15 cm	30 kg	1189.-	1139.-
Replacement base frame Aluminium, natural lacquered, height adjustable Frame height: 8 cm	→ 210 cm ↗ 52 cm ↑ 15 cm	30 kg	1189.-	1139.-

Bestell-Nr. N° de commande Reference no.	Ersatzteile	Pièces de rechange
44-040-221-013	 Ersatzabdeckung Abdeckung: Melamin seidenmatt schwarz Profil: Aluminium natur eloxiert	Dessus de rechange Dessus: mélamine noire satinée Profilé: aluminium anodisé naturel
44-040-221-014	 Ersatzabdeckung Abdeckung: Melamin seidenmatt schwarz Profil: Aluminium schwarz eloxiert	Dessus de rechange Dessus: mélamine noire satinée Profilé: aluminium anodisé noir
44-040-229-013	 Ersatzabdeckung Abdeckung: Melamin seidenmatt weiss Profil: Aluminium natur eloxiert	Dessus de rechange Dessus: mélamine blanche satinée Profilé: aluminium anodisé naturel
44-040-571-013	 Ersatzglasabdeckung Abdeckung: Klarglas schwarz unterlackiert Profil: Aluminium natur eloxiert	Dessus de rechange Dessus: verre transparent au dessous laqué noir Profilé: aluminium anodisé naturel
44-040-571-014	 Ersatzglasabdeckung Abdeckung: Klarglas schwarz unterlackiert Profil: Aluminium schwarz eloxiert	Dessus de rechange Dessus: verre transparent au dessous laqué noir Profilé: aluminium anodisé noir
44-040-561-013	 Ersatzglasabdeckung Abdeckung: Klarglas weiss unterlackiert Profil: Aluminium natur eloxiert	Dessus de rechange Dessus: verre transparent au dessous laqué blanc Profilé: aluminium anodisé naturel

Spare parts	Verpackungsmasse Dimensions de l'emballage Package dimensions	Gewicht Poids Weight	CHF	EUR
Replacement cover Cover: melamine, silky matt black Profiles: aluminium, natural anodized	→ 230 cm ↗ 60 cm ↑ 4 cm	15 kg	479.-	459.-
Replacement cover Cover: melamine, silky matt black Profiles: aluminium, black anodized	→ 230 cm ↗ 60 cm ↑ 4 cm	15 kg	479.-	459.-
Replacement cover Cover: melamine, silky matt white Profiles: aluminium, natural anodized	→ 230 cm ↗ 60 cm ↑ 4 cm	15 kg	479.-	459.-
Replacement cover Cover: clear glass, black-lacquered underside Profiles: aluminium, natural anodized	→ 230 cm ↗ 60 cm ↑ 4 cm	35 kg	979.-	939.-
Replacement cover Cover: clear glass, black-lacquered underside Profiles: aluminium, black anodized	→ 230 cm ↗ 60 cm ↑ 4 cm	35 kg	979.-	939.-
Replacement cover Cover: clear glass, white-lacquered underside Profiles: aluminium, natural anodized	→ 230 cm ↗ 60 cm ↑ 4 cm	35 kg	979.-	939.-



Ellipsetower

Design:
Benny Mosimann
1996

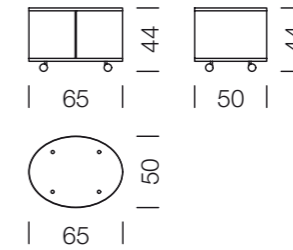

Masse in cm
Dimensions en cm
Dimensions in cm



Bestell-Nr. N° de commande Reference no.	Ausführung, Farbe & Material	Finition, matériau & couleur
	Boden: Melamin seidenmatt schwarz Schieber: Kunststoff (PP) schwarz Profilé: Aluminium schwarz eloxiert Rückwand: Kunststoff (PP) schwarz Schwenkrollen: Kunststoff schwarz Rollenhöhe: 6.5 cm	Base: mélamine noire satinée Portes coulissantes: plastique (PP) noir Profilé: aluminium anodisé noir Panneau arrière: plastique (PP) noir Roulettes pivotantes: plastique noir Hauteur des roulettes: 6.5 cm
17-001-221-221-071-014	Abdeckung: Melamin seidenmatt schwarz	Dessus: mélamine noire satinée
17-001-221-571-071-014	Abdeckung: Klarglas schwarz unterlackiert	Dessus: verre transparent au dessous laqué noir
	Boden: Melamin seidenmatt weiss Schieber: Kunststoff (PP) opalweiss Profilé: Aluminium natur eloxiert Rückwand: Kunststoff (PP) opalweiss Schwenkrollen: Kunststoff grau Rollenhöhe: 6.5 cm	Base: mélamine blanche satinée Portes coulissantes: plastique (PP) blanc opalin Profilé: aluminium anodisé naturel Panneau arrière: plastique (PP) blanc opalin Roulettes pivotantes: plastique gris Hauteur des roulettes: 6.5 cm
17-001-229-229-056-013	Abdeckung: Melamin seidenmatt weiss	Dessus: mélamine blanche satinée
17-001-229-561-056-013	Abdeckung: Klarglas weiss unterlackiert	Dessus: verre transparent au dessous laqué blanc

Finish, material & colour	Verpackungsmasse Dimensions de l'emballage Package dimensions	Gewicht Poids Weight	CHF	EUR
Base: melamine, silky matt black Sliding doors: plastic (PP), black Profiles: aluminium, black anodized Back wall: plastic (PP), black Castors: plastic, black Castor height: 6.5 cm	→ 71 cm ↗ 56 cm ↑ 48 cm			
Cover: melamine, silky matt black		12 kg	1149.-	1099.-
Cover: clear glass, black-lacquered underside		15 kg	1329.-	1269.-
Base: melamine, silky matt white Sliding doors: plastic (PP), opal white Profiles: aluminium, natural anodized Back wall: plastic (PP), opal white Castors: plastic, grey Castor height: 6.5 cm	→ 71 cm ↗ 56 cm ↑ 48 cm			
Cover: melamine, silky matt white		12 kg	1149.-	1099.-
Cover: clear glass, white-lacquered underside		15 kg	1329.-	1269.-

Preise: UVP exkl. MwSt.
 Prix: prix de vente
 conseillés hors TVA
 Prices: RRP ex. VAT



Ellipsetower

Design:
Benny Mosimann
1996

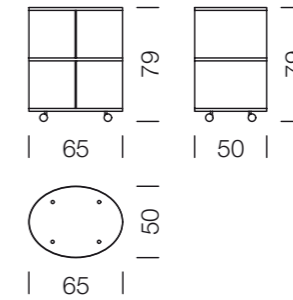

Masse in cm
Dimensions en cm
Dimensions in cm



Bestell-Nr. N° de commande Reference no.	Ausführung, Farbe & Material	Finition, matériau & couleur
	Boden: Melamin seidenmatt schwarz Schieber: Kunststoff (PP) schwarz Profil: Aluminium schwarz eloxiert Rückwand: Kunststoff (PP) schwarz Schwenkrollen: Kunststoff schwarz Rollenhöhe: 6.5 cm	Base: mélamine noire satinée Portes coulissantes: plastique (PP) noir Profilé: aluminium anodisé noir Panneau arrière: plastique (PP) noir Roulettes pivotantes: plastique noir Hauteur des roulettes: 6.5 cm
17-002-221-221-071-014	Abdeckung: Melamin seidenmatt schwarz	Dessus: mélamine noire satinée
17-002-221-571-071-014	Abdeckung: Klarglas schwarz unterlackiert	Dessus: verre transparent au dessous laqué noir
	Boden: Melamin seidenmatt weiss Schieber: Kunststoff (PP) opalweiss Profil: Aluminium natur eloxiert Rückwand: Kunststoff (PP) opalweiss Schwenkrollen: Kunststoff grau Rollenhöhe: 6.5 cm	Base: mélamine blanche satinée Portes coulissantes: plastique (PP) blanc opalin Profilé: aluminium anodisé naturel Panneau arrière: plastique (PP) blanc opalin Roulettes pivotantes: plastique gris Hauteur des roulettes: 6.5 cm
17-002-229-229-056-013	Abdeckung: Melamin seidenmatt weiss	Dessus: mélamine blanche satinée
17-002-229-561-056-013	Abdeckung: Klarglas weiss unterlackiert	Dessus: verre transparent au dessous laqué blanc

Finish, material & colour	Verpackungsmasse Dimensions de l'emballage Package dimensions	Gewicht Poids Weight	CHF	EUR
Base: melamine, silky matt black Sliding doors: plastic (PP), black Profiles: aluminium, black anodized Back wall: plastic (PP), black Castors: plastic, black Castor height: 6.5 cm	→ 71 cm ↗ 56 cm ↑ 83 cm			
Cover: melamine, silky matt black		18 kg	1599.-	1529.-
Cover: clear glass, black-lacquered underside		21 kg	1779.-	1699.-
Base: melamine, silky matt white Sliding doors: plastic (PP), opal white Profiles: aluminium, natural anodized Back wall: plastic (PP), opal white Castors: plastic, grey Castor height: 6.5 cm	→ 71 cm ↗ 56 cm ↑ 83 cm			
Cover: melamine, silky matt white		18 kg	1599.-	1529.-
Cover: clear glass, white-lacquered underside		21 kg	1779.-	1699.-

Preise: UVP exkl. MwSt.
 Prix: prix de vente
 conseillés hors TVA
 Prices: RRP ex. VAT

Ellipsetower

Design:
Benny Mosimann
1996



Masse in cm
Dimensions en cm
Dimensions in cm

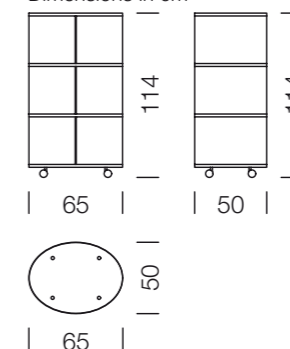





Bestell-Nr. N° de commande Reference no.	Ausführung, Farbe & Material	Finition, matériau & couleur
	<p>Boden: Melamin seidenmatt schwarz Schieber: Kunststoff (PP) schwarz Profil: Aluminium schwarz eloxiert Rückwand: Kunststoff (PP) schwarz Schwenkrollen: Kunststoff schwarz Rollenhöhe: 6.5 cm</p>	<p>Base: mélamine noire satinée Portes coulissantes: plastique (PP) noir Profilé: aluminium anodisé noir Panneau arrière: plastique (PP) noir Roulettes pivotantes: plastique noir Hauteur des roulettes: 6.5 cm</p>
17-003-221-221-071-014	Abdeckung: Melamin seidenmatt schwarz	Dessus: mélamine noire satinée
17-003-221-571-071-014	Abdeckung: Klarglas schwarz unterlackiert	Dessus: verre transparent au dessous laqué noir

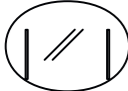

	<p>Boden: Melamin seidenmatt weiss Schieber: Kunststoff (PP) opalweiss Profil: Aluminium natur eloxiert Rückwand: Kunststoff (PP) opalweiss Schwenkrollen: Kunststoff grau Rollenhöhe: 6.5 cm</p>	<p>Base: mélamine blanche satinée Portes coulissantes: plastique (PP) blanc opalin Profilé: aluminium anodisé naturel Panneau arrière: plastique (PP) blanc opalin Roulettes pivotantes: plastique gris Hauteur des roulettes: 6.5 cm</p>
17-003-229-229-056-013	Abdeckung: Melamin seidenmatt weiss	Dessus: mélamine blanche satinée
17-003-229-561-056-013	Abdeckung: Klarglas weiss unterlackiert	Dessus: verre transparent au dessous laqué blanc

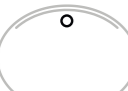
Finish, material & colour	Verpackungsmasse Dimensions de l'emballage Package dimensions	Gewicht Poids Weight	CHF	EUR
<p>Base: melamine, silky matt black Sliding doors: plastic (PP), black Profiles: aluminium, black anodized Back wall: plastic (PP), black Castors: plastic, black Castor height: 6.5 cm</p>	<p>→ 71 cm ↗ 56 cm ↑ 118 cm</p>			
Cover: melamine, silky matt black		23 kg	2199.-	2099.-
Cover: clear glass, black-lacquered underside		26 kg	2379.-	2269.-
<p>Base: melamine, silky matt white Sliding doors: plastic (PP), opal white Profiles: aluminium, natural anodized Back wall: plastic (PP), opal white Castors: plastic, grey Castor height: 6.5 cm</p>	<p>→ 71 cm ↗ 56 cm ↑ 118 cm</p>			
Cover: melamine, silky matt white		23 kg	2199.-	2099.-
Cover: clear glass, white-lacquered underside		26 kg	2379.-	2269.-

Preise: UVP exkl. MwSt.
Prix: prix de vente
conseillés hors TVA
Prices: RRP ex. VAT

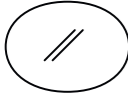
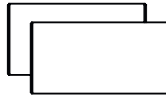
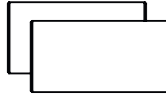
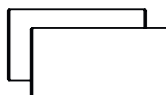

Bestell-Nr. N° de commande Reference no.	Zubehör	Accessoires
	Glastablar, Tablar: Klarglas Grösse: 56 x 42 cm h= 0.8 cm Tablarträger: 2 höhenverstellbare Konsolen Acryl (Raster: 4 cm)	Étagère en verre, étagère: verre transparent Dimensions: 56 x 42 cm h= 0.8 cm Supports d'étagère: 2 consoles en acrylique réglables en hauteur (pas: 4 cm)
17-011-551-051		
	Kabeldurchführung, Farbe: Kunststoff schwarz Durchmesser: 7 cm, Innendurchmesser: 5.5 cm Polistionierung: hinten mittig Wahlweise in Deckel / Boden / Abdeckung aus Melamin	Passage de câbles, couleur: plastique noir Diamètre: 7 cm, diamètre intérieur: 5.5 cm Positionnement: arrière central Au choix dans plateau/base/dessus en mélamine
17-012-062		
	Kabeldurchführung, Farbe: Kunststoff weiss Durchmesser: 7 cm, Innendurchmesser: 5.5 cm Polistionierung: hinten mittig Wahlweise in Deckel / Boden / Abdeckung aus Melamin	Passage de câbles, couleur: plastique blanc Diamètre: 7 cm, diamètre intérieur: 5.5 cm Positionnement: arrière central Au choix dans plateau/base/dessus en mélamine
17-012-061		
	Glasabdeckplatte, Klarglas schwarz unterlackiert Inkl. Klebeband zum auflegen und aufkleben, auf den bestehenden Deckel (aus Melamin)	Plaque de dessus en verre, verre transparent au dessous laqué noir Avec bande adhésive à poser et à coller sur dessus d'origine (en mélamine)
17-030-571		
	Glasabdeckplatte, Klarglas weiss unterlackiert Inkl. Klebeband zum auflegen und aufkleben, auf den bestehenden Deckel (aus Melamin)	Plaque de dessus en verre, verre transparent au dessous laqué blanc Avec bande adhésive à poser et à coller sur dessus d'origine (en mélamine)
17-030-561		

Accessories	Verpackungsmasse Dimensions de l'emballage Package dimensions	Gewicht Poids Weight	CHF	EUR
Glass shelf, Shelf: clear glass Dimensions: 56 x 42 cm h= 0.8 cm Shelf supports: 2 height-adjustable acrylic brackets (in 4 cm increments)	→ 60 cm ↗ 46 cm ↑ 3 cm	5 kg	299.-	289.-
Cable grommet, Colour: plastic, black Diameter: 7 cm, Inner diameter: 5.5 cm Positioning: centre back Optional lid / base / cover made of melamine			49.-	49.-
Cable grommet, Colour: plastic, white Diameter: 7 cm, Inner diameter: 5.5 cm Positioning: centre back Optional lid / base / cover made of melamine			49.-	49.-
Glass cover plate, Clear glass, black-lacquered underside Incl. adhesive tape to place and stick on existing lid (made of melamine)	→ 71 cm ↗ 56 cm ↑ 4 cm	6 kg	249.-	239.-
Glass cover plate, Clear glass, white-lacquered underside Incl. adhesive tape to place and stick on existing lid (made of melamine)	→ 71 cm ↗ 56 cm ↑ 4 cm	6 kg	249.-	239.-

Bestell-Nr. N° de commande Reference no.	Ersatzteile	Pièces de rechange
	Ersatztablarträger, 2 Stück Höhenverstellbare Konsolen Acryl (Raster: 4 cm)	Supports d'étagère de rechange, 2 pièces Consoles en acrylique réglables en hauteur (pas: 4 cm)
17-011-051		
	Ersatzglastablar Tablar: Klarglas Grösse: 56 x 42 cm h= 0.8 cm	Étagère en verre de rechange Étagère: verre transparent Dimensions: 56 x 42 cm h= 0.8 cm
17-011-551		
	Ersatzschieber, 2 Stück Farbe: Kunststoff (PP) schwarz Grösse: 65.6 x 33.9 cm Profil: Aluminium natur	Portes coulissantes de rechange, 2 pièces Couleur: plastique (PP) noir Dimensions: 65.6 x 33.9 cm Profilé: aluminium naturel
17-020-071-013		
	Ersatzschieber, 2 Stück Farbe: Kunststoff (PP) schwarz Grösse: 65.6 x 33.9 cm Profil: Aluminium schwarz eloxiert	Portes coulissantes de rechange, 2 pièces Couleur: plastique (PP) noir Dimensions: 65.6 x 33.9 cm Profilé: aluminium anodisé noir
17-020-071-014		
	Ersatzschieber, 2 Stück Farbe: Kunststoff (PP) opalweiss Grösse: 65.6 x 33.9 cm Profil: Aluminium natur	Portes coulissantes de rechange, 2 pièces Couleur: plastique (PP) blanc opalin Dimensions: 65.6 x 33.9 cm Profilé: aluminium naturel
17-020-056-013		
	Ersatzrückwand Grösse: 50.5 x 34 cm Kunststoff (PP) schwarz	Panneau arrière de rechange Dimensions: 50.5 x 34 cm Plastique noir
17-021-071		
	Ersatzrückwand Grösse: 50.5 x 34 cm Kunststoff (PP) opalweiss	Panneau arrière de rechange Dimensions: 50.5 x 34 cm Plastique blanc opalin
17-021-056		

Spare parts	Verpackungsmasse Dimensions de l'emballage Package dimensions	Gewicht Poids Weight	CHF	EUR
Replacement tray supports, 2 pieces Height-adjustable acrylic brackets (in 4 cm increments)	→ 40 cm ↗ 20 cm ↑ 20 cm	2 kg	189.-	189.-
Replacement glass shelf Shelf: clear glass Dimensions: 56 x 42 cm h= 0.8 cm	→ 60 cm ↗ 46 cm ↑ 3 cm	4 kg	119.-	119.-
Replacement sliding doors, 2 pieces Colour: plastic (PP), black Dimensions: 65.6 x 33.9 cm Profiles: aluminium, natural anodized	→ 40 cm ↗ 40 cm ↑ 40 cm	2 kg	319.-	309.-
Replacement sliding doors, 2 pieces Colour: plastic (PP), black Dimensions: 65.6 x 33.9 cm Profiles: aluminium, black anodized	→ 40 cm ↗ 40 cm ↑ 40 cm	2 kg	319.-	309.-
Replacement sliding doors, 2 pieces Colour: plastic (PP), opal white Dimensions: 65.6 x 33.9 cm Profiles: aluminium, natural anodized	→ 40 cm ↗ 40 cm ↑ 40 cm	2 kg	319.-	309.-
Replacement back wall Dimensions: 50.5 x 34 cm Plastic, black	→ 40 cm ↗ 40 cm ↑ 40 cm	1 kg	49.-	49.-
Replacement back wall Dimensions: 50.5 x 34 cm Plastic, opal white	→ 40 cm ↗ 40 cm ↑ 40 cm	1 kg	49.-	49.-

Preise: UVP exkl. MwSt.
Prix: prix de vente
conseillés hors TVA
Prices: RRP ex. VAT

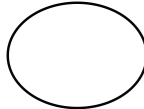
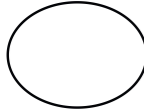
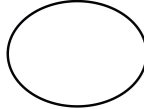
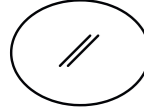
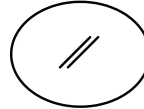
Bestell-Nr. N° de commande Reference no.	Ersatzteile	Pièces de rechange
	Ersatzschwenkrolle Kunststoff schwarz Rollenhöhe: 6.5 cm	Roulette pivotante de rechange Plastique noir Hauteur de la roulette: 6.5 cm
17-022-062		
	Ersatzschwenkrolle Kunststoff grau Rollenhöhe: 6.5 cm	Roulette pivotante de rechange Plastique gris Hauteur de la roulette: 6.5 cm
17-022-063		
	Ersatzabdeckung Abdeckung: Melamin seidenmatt schwarz Profil: Aluminium natur eloxiert	Dessus de rechange Dessus: mélamine noire satinée Profilé: aluminium anodisé naturel
17-040-221-013		
	Ersatzabdeckung Abdeckung: Melamin seidenmatt schwarz Profil: Aluminium schwarz eloxiert	Dessus de rechange Dessus: mélamine noire satinée Profilé: aluminium anodisé noir
17-040-221-014		
	Ersatzabdeckung Abdeckung: Melamin seidenmatt weiss Profil: Aluminium natur eloxiert	Dessus de rechange Dessus: mélamine blanche satinée Profilé: aluminium anodisé naturel
17-040-229-013		
	Ersatzglasabdeckung Abdeckung: Klarglas schwarz unterlackiert Profil: Aluminium natur eloxiert	Dessus en verre de rechange Dessus: verre transparent au dessous laqué noir Profilé: aluminium anodisé naturel
17-040-571-013		
	Ersatzglasabdeckung Abdeckung: Klarglas schwarz unterlackiert Profil: Aluminium schwarz eloxiert	Dessus en verre de rechange Dessus: verre transparent au dessous laqué noir Profilé: aluminium anodisé noir
17-040-571-014		

Spare parts	Verpackungsmasse Dimensions de l'emballage Package dimensions	Gewicht Poids Weight	CHF	EUR
Replacement castor Plastic, black Castor height: 6.5 cm	→ 20 cm ↗ 20 cm ↑ 20 cm	1 kg	29.-	29.-
Replacement castor Plastic, grey Castor height: 6.5 cm	→ 20 cm ↗ 20 cm ↑ 20 cm	1 kg	29.-	29.-
Replacement cover Cover: melamine, silky matt black Profiles: aluminium, natural anodized	→ 71 cm ↗ 56 cm ↑ 4 cm	5 kg	289.-	279.-
Replacement cover Cover: melamine, silky matt black Profiles: aluminium, black anodized	→ 71 cm ↗ 56 cm ↑ 4 cm	5 kg	289.-	279.-
Replacement cover Cover: melamine, silky matt white Profiles: aluminium, natural anodized	→ 71 cm ↗ 56 cm ↑ 4 cm	5 kg	289.-	279.-
Replacement glass cover Cover: clear glass, black-lacquered underside Profiles: aluminium, natural anodized	→ 71 cm ↗ 56 cm ↑ 4 cm	11 kg	649.-	619.-
Replacement glass cover Cover: clear glass, black-lacquered underside Profiles: aluminium, black anodized	→ 71 cm ↗ 56 cm ↑ 4 cm	11 kg	649.-	619.-

Preise: UVP exkl. MwSt.
Prix: prix de vente
conseillés hors TVA
Prices: RRP ex. VAT

Bestell-Nr. N° de commande Reference no.	Ersatzteile	Pièces de rechange
	Ersatzglasabdeckung Abdeckung: Klarglas weiss unterlackiert Profil: Aluminium natur eloxiert	Dessus en verre de rechange Dessus: verre transparent au dessous laqué blanc Profilé: aluminium anodisé naturel
17-040-561-013		

Spare parts	Verpackungsmasse Dimensions de l'emballage Package dimensions	Gewicht Poids Weight	CHF	EUR
Replacement glass cover Cover: clear glass, white-lacquered underside Profiles: aluminium, natural anodized	→ 71 cm ↗ 56 cm ↑ 4 cm			
		11 kg	649.-	619.-

Design:
Benny Mosimann
2019



Masse in cm
Dimensions en cm
Dimensions in cm

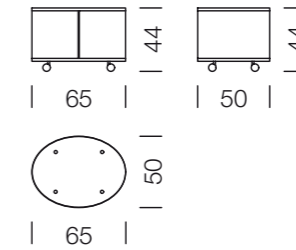

Bestell-Nr. N° de commande Reference no.	Ausführung, Farbe & Material	Finition, matériau & couleur
	Boden: Eichenfurnier schwarz Schieber: Eichenfurnier schwarz Profil: Aluminium schwarz eloxiert Rückwand: Eichenfurnier schwarz Schwenkrollen: Kunststoff schwarz	Base: chêne plaqué noir Portes coulissantes: chêne plaqué noir Profilé: aluminium anodisé naturel Panneau arrière: chêne plaqué noir Roulettes pivotantes: plastique noir
67-001-077-077-077-014	Abdeckung: Eichenfurnier schwarz	Dessus: chêne plaqué noir
67-001-077-571-077-014	Abdeckung: Klarglas schwarz unterlackiert	Dessus: verre transparent au dessous laqué noir

	Boden: Eichenfurnier weiss Schieber: Eichenfurnier weiss Profil: Aluminium natur eloxiert Rückwand: Eichenfurnier weiss Schwenkrollen: Kunststoff grau	Base: chêne plaqué blanc Portes coulissantes: chêne plaqué blanc Profilé: aluminium anodisé blanc Panneau arrière: chêne plaqué noir Roulettes pivotantes: plastique gris
67-001-076-076-076-013	Abdeckung: Eichenfurnier weiss	Dessus: chêne plaqué blanc
67-001-076-561-076-013	Abdeckung: Klarglas weiss unterlackiert	Dessus: verre transparent au dessous laqué blanc

Finish, material & colour	Verpackungsmasse Dimensions de l'emballage Package dimensions	Gewicht Poids Weight	CHF	EUR
Base: oak veneer, black Sliding doors: oak veneer, black Profiles: aluminium, black anodized Back wall: oak veneer, black Castors: plastic, black	→ 71 cm ↗ 56 cm ↑ 48 cm			
Cover: oak veneer, black		12 kg	1699.-	1619.-
Cover: clear glass, black-lacquered underside		15 kg	1879.-	1789.-
Base: oak veneer, white Sliding doors: oak veneer, white Profiles: aluminium, natural anodized Back wall: oak veneer, white Castors: plastic, grey	→ 71 cm ↗ 56 cm ↑ 48 cm			
Cover: oak veneer, white		12 kg	1699.-	1619.-
Cover: clear glass, white-lacquered underside		15 kg	1879.-	1789.-

Preise: UVP exkl. MwSt.
Prix: prix de vente
conseillés hors TVA
Prices: RRP ex. VAT

Design:
Benny Mosimann
2019



Masse in cm
Dimensions en cm
Dimensions in cm

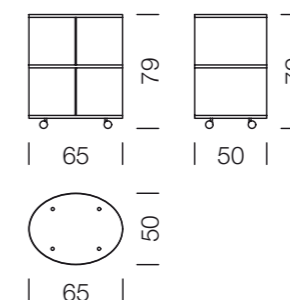

Bestell-Nr. N° de commande Reference no.	Ausführung, Farbe & Material	Finition, matériau & couleur
	Boden: Eichenfurnier schwarz Schieber: Eichenfurnier schwarz Profil: Aluminium schwarz eloxiert Rückwand: Eichenfurnier schwarz Schwenkrollen: Kunststoff schwarz	Base: chêne plaqué noir Portes coulissantes: chêne plaqué noir Profilé: aluminium anodisé noir Panneau arrière: chêne plaqué noir Roulettes pivotantes: plastique noir
67-002-077-077-077-014	Abdeckung: Eichenfurnier schwarz	Dessus: chêne plaqué noir
67-002-077-571-077-014	Abdeckung: Klarglas schwarz unterlackiert	Dessus: verre transparent au dessous laqué noir

	Boden: Eichenfurnier weiss Schieber: Eichenfurnier weiss Profil: Aluminium natur eloxiert Rückwand: Eichenfurnier weiss Schwenkrollen: Kunststoff grau	Base: chêne plaqué blanc Portes coulissantes: chêne plaqué blanc Profilé: aluminium anodisé naturel Panneau arrière: chêne plaqué blanc Roulettes pivotantes: plastique gris
67-002-076-076-076-013	Abdeckung: Eichenfurnier weiss	Dessus: chêne plaqué blanc
67-002-076-561-076-013	Abdeckung: Klarglas weiss unterlackiert	Dessus: verre transparent au dessous laqué blanc

Finish, material & colour	Verpackungsmasse Dimensions de l'emballage Package dimensions	Gewicht Poids Weight	CHF	EUR
Base: oak veneer, black Sliding doors: oak veneer, black Profiles: aluminium, black anodized Back wall: oak veneer, black Castors: plastic, black	→ 71 cm ↗ 56 cm ↑ 83 cm			
Cover: oak veneer, black		18 kg	2699.-	2579.-
Cover: clear glass, black-lacquered underside		21 kg	3079.-	2939.-
Base: oak veneer, white Sliding doors: oak veneer, white Profiles: aluminium, natural anodized Back wall: oak veneer, white Castors: plastic, grey	→ 71 cm ↗ 56 cm ↑ 83 cm			
Cover: oak veneer, white		18 kg	2699.-	2579.-
Cover: clear glass, white-lacquered underside		21 kg	3079.-	2939.-

Preise: UVP exkl. MwSt.
Prix: prix de vente
conseillés hors TVA
Prices: RRP ex. VAT

Ellipsetower wood

Design:
Benny Mosimann
2019



Masse in cm
Dimensions en cm
Dimensions in cm

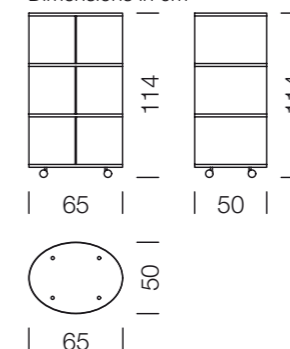





Bestell-Nr. N° de commande Reference no.	Ausführung, Farbe & Material	Finition, matériau & couleur
	Boden: Eichenfurnier schwarz Schieber: Eichenfurnier schwarz Profil: Aluminium schwarz eloxiert Rückwand: Eichenfurnier schwarz Schwenkrollen: Kunststoff schwarz	Base: chêne plaqué noir Portes coulissantes: chêne plaqué noir Profilé: aluminium anodisé noir Panneau arrière: chêne plaqué noir Roulettes pivotantes: plastique noir
67-003-077-077-077-014	Abdeckung: Eichenfurnier schwarz	Dessus: chêne plaqué noir
67-003-077-571-077-014	Abdeckung: Klarglas schwarz unterlackiert	Dessus: verre transparent au dessous laqué noir



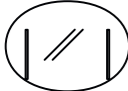

	Boden: Eichenfurnier weiss Schieber: Eichenfurnier weiss Profil: Aluminium natur eloxiert Rückwand: Eichenfurnier weiss Schwenkrollen: Kunststoff grau	Base: chêne plaqué blanc Portes coulissantes: chêne plaqué blanc Profilé: aluminium anodisé naturel Panneau arrière: chêne plaqué blanc Roulettes pivotantes: plastique gris
67-003-076-076-076-013	Abdeckung: Eichenfurnier weiss	Dessus: chêne plaqué blanc
67-003-076-561-076-013	Abdeckung: Klarglas weiss unterlackiert	Dessus: verre transparent au dessous laqué blanc

Finish, material & colour	Verpackungsmasse Dimensions de l'emballage Package dimensions	Gewicht Poids Weight	CHF	EUR
Base: oak veneer, black Sliding doors: oak veneer, black Profiles: aluminium, black anodized Back wall: oak veneer, black Castors: plastic, black	→ 71 cm ↗ 56 cm ↑ 118 cm			
Cover: oak veneer, black		23 kg	3799.-	3619.-
Cover: clear glass, black-lacquered underside		26 kg	3979.-	3789.-
Base: oak veneer, white Sliding doors: oak veneer, white Profiles: aluminium, natural anodized Back wall: oak veneer, white Castors: plastic, grey	→ 71 cm ↗ 56 cm ↑ 118 cm			
Cover: oak veneer, white		23 kg	3799.-	3619.-
Cover: clear glass, white-lacquered underside		26 kg	3979.-	3789.-

Preise: UVP exkl. MwSt.
 Prix: prix de vente
 conseillés hors TVA
 Prices: RRP ex. VAT

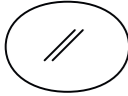
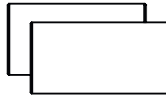
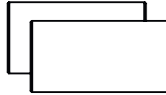
Bestell-Nr. N° de commande Reference no.	Zubehör	Accessoires
	Glastablar, Tablar: Klarglas Grösse: 56 x 42 cm h= 0.8 cm Tablarträger: 2 höhenverstellbare Konsolen Acryl (Raster: 4 cm)	Étagère en verre, étagère: verre transparent Dimensions: 56 x 42 cm h= 0.8 cm Supports d'étagère: 2 consoles en acrylique réglables en hauteur (pas: 4 cm)
67-011-551-051		
	Kabeldurchführung, Farbe: Kunststoff schwarz Durchmesser: 7 cm, Innendurchmesser: 5.5 cm Positionierung: hinten mittig Wahlweise in Deckel / Boden / Abdeckung aus Melamin	Passage de câbles, couleur: plastique noir Diamètre: 7 cm, diamètre intérieur: 5.5 cm Positionnement: arrière central Au choix dans plateau/base/dessus en mélamine
67-012-062		
	Kabeldurchführung, Farbe: Kunststoff weiss Durchmesser: 7 cm, Innendurchmesser: 5.5 cm Positionierung: hinten mittig Wahlweise in Deckel / Boden / Abdeckung aus Melamin	Passage de câbles, couleur: plastique blanc Diamètre: 7 cm, diamètre intérieur: 5.5 cm Positionnement: arrière central Au choix dans plateau/base/dessus en mélamine
67-012-061		
	Glasabdeckplatte, Klarglas schwarz unterlackiert Inkl. Klebeband zum auflegen und aufkleben, auf den bestehenden Deckel (aus Melamin)	Plaque de dessus en verre, verre transparent au dessous laqué noir Avec bande adhésive à poser et à coller sur dessus d'origine (en mélamine)
67-030-571		
	Glasabdeckplatte, Klarglas weiss unterlackiert Inkl. Klebeband zum auflegen und aufkleben, auf den bestehenden Deckel (aus Melamin)	Plaque de dessus en verre, verre transparent au dessous laqué blanc Avec bande adhésive à poser et à coller sur dessus d'origine (en mélamine)
67-030-561		

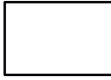
Accessories	Verpackungsmasse Dimensions de l'emballage Package dimensions	Gewicht Poids Weight	CHF	EUR
Glass shelf, Shelf: clear glass Dimensions: 56 x 42 cm h= 0.8 cm Shelf supports: 2 height-adjustable acrylic brackets (in 4 cm increments)	→ 60 cm ↗ 46 cm ↑ 3 cm	5 kg	299.-	289.-
Cable grommet, Colour: plastic, black Diameter: 7 cm, Inner diameter: 5.5 cm Positioning: centre back Optional lid / base / cover made of melamine			49.-	49.-
Cable grommet, Colour: plastic, white Diameter: 7 cm, Inner diameter: 5.5 cm Positioning: centre back Optional lid / base / cover made of melamine			49.-	49.-
Glass cover plate, Clear glass, black-lacquered underside Incl. adhesive tape to place and stick on existing lid (made of melamine)	→ 71 cm ↗ 56 cm ↑ 4 cm	6 kg	249.-	239.-
Glass cover plate, Clear glass, white-lacquered underside Incl. adhesive tape to place and stick on existing lid (made of melamine)	→ 71 cm ↗ 56 cm ↑ 4 cm	6 kg	249.-	239.-

Bestell-Nr. N° de commande Reference no.	Ersatzteile	Pièces de rechange
	Ersatztablarträger, 2 Stück Höhenverstellbare Konsolen Acryl (Raster: 4 cm)	Supports d'étagère de rechange, 2 pièces Consoles en acrylique réglables en hauteur (pas: 4 cm)
67-011-051		
	Ersatzglastablar Tablar: Klarglas Grösse: 56 x 42 cm h= 0.8 cm	Étagère en verre de rechange Étagère: verre transparent Dimensions: 56 x 42 cm h= 0.8 cm
67-011-551		
	Ersatzschieber, 2 Stück Farbe: Eichenfurnier schwarz Grösse: 65.6 x 33.9 cm Profil: Aluminium schwarz eloxiert	Portes coulissantes de rechange, 2 pièces Couleur: chêne plaqué noir Dimensions: 65.6 x 33.9 cm Profilé: aluminium anodisé noir
67-020-077-014		
	Ersatzschieber, 2 Stück Farbe: Eichenfurnier weiss Grösse: 65.6 x 33.9 cm Profil: Aluminium natur eloxiert	Portes coulissantes de rechange, 2 pièces Couleur: chêne plaqué blanc Dimensions: 65.6 x 33.9 cm Profilé: aluminium anodisé naturel
67-020-076-013		
	Ersatzrückwand Farbe: Eichenfurnier schwarz Grösse: 50.5 x 34 cm	Panneau arrière de rechange Couleur: chêne plaqué noir Dimensions: 50.5 x 34 cm
67-021-077		
	Ersatzrückwand Farbe: Eichenfurnier weiss Grösse: 50.5 x 34 cm	Panneau arrière de rechange Couleur: chêne plaqué blanc Dimensions: 50.5 x 34 cm
67-021-076		
	Ersatzschwenkrolle Kunststoff schwarz	Roulette pivotante de rechange Plastique noir
67-022-062		

Spare parts	Verpackungsmasse Dimensions de l'emballage Package dimensions	Gewicht Poids Weight	CHF	EUR
Replacement tray supports, 2 pieces Height-adjustable acrylic brackets (in 4 cm increments)	→ 40 cm ↗ 20 cm ↑ 20 cm	2 kg	189.-	189.-
Replacement glass shelf Shelf: clear glass Dimensions: 56 x 42 cm h= 0.8 cm	→ 60 cm ↗ 46 cm ↑ 3 cm	4 kg	119.-	119.-
Replacement sliding doors, 2 pieces Colour: oak veneer, black Dimensions: 65.6 x 33.9 cm Profiles: aluminium, black anodized	→ 40 cm ↗ 40 cm ↑ 40 cm	2 kg	499.-	479.-
Replacement sliding doors, 2 pieces Colour: oak veneer, white Dimensions: 65.6 x 33.9 cm Profiles: aluminium, natural anodized	→ 40 cm ↗ 40 cm ↑ 40 cm	2 kg	499.-	479.-
Replacement back wall Colour: oak veneer, black Dimensions: 50.5 x 34 cm	→ 40 cm ↗ 40 cm ↑ 40 cm	1 kg	199.-	189.-
Replacement back wall Colour: oak veneer, white Dimensions: 50.5 x 34 cm	→ 40 cm ↗ 40 cm ↑ 40 cm	1 kg	199.-	189.-
Replacement castor Plastic, black	→ 20 cm ↗ 20 cm ↑ 20 cm	1 kg	29.-	29.-

Preise: UVP exkl. MwSt.
Prix: prix de vente
conseillés hors TVA
Prices: RRP ex. VAT

Bestell-Nr. N° de commande Reference no.	Ersatzteile	Pièces de rechange
	Ersatzschwenkrolle Kunststoff grau	Roulette pivotante de rechange Plastique gris
67-022-063		
	Ersatzabdeckung Abdeckung: Eichenfurnier schwarz Profil: Aluminium schwarz eloxiert	Dessus de rechange Dessus: chêne plaqué noir Profilé: aluminium anodisé noir
67-040-077-014		
	Ersatzabdeckung Abdeckung: Eichenfurnier weiss Profil: Aluminium natur eloxiert	Dessus de rechange Dessus: chêne plaqué blanc Profilé: aluminium anodisé naturel
67-040-067-013		
	Ersatzglasabdeckung Abdeckung: Klarglas schwarz unterlackiert Profil: Aluminium schwarz eloxiert	Dessus en verre de rechange Dessus: verre transparent au dessous laqué noir Profilé: aluminium anodisé noir
67-040-571-016		
	Ersatzglasabdeckung Abdeckung: Klarglas weiss unterlackiert Profil: Aluminium natur eloxiert	Dessus en verre de rechange Dessus: verre transparent au dessous laqué blanc Profilé: aluminium anodisé naturel
67-040-561-013		

Spare parts	Verpackungsmasse Dimensions de l'emballage Package dimensions	Gewicht Poids Weight	CHF	EUR
Replacement castor Plastic, grey	→ 20 cm ↗ 20 cm ↑ 20 cm	1 kg	29.-	29.-
Replacement cover Cover: oak veneer, black Profiles: aluminium, black anodized	→ 71 cm ↗ 56 cm ↑ 4 cm	5 kg	359.-	349.-
Replacement cover Cover: oak veneer, white Profiles: aluminium, natural anodized	→ 71 cm ↗ 56 cm ↑ 4 cm	5 kg	359.-	349.-
Replacement glass cover Cover: clear glass, black-lacquered underside Profiles: aluminium, black anodized	→ 71 cm ↗ 56 cm ↑ 4 cm	11 kg	649.-	619.-
Replacement glass cover Cover: clear glass, white-lacquered underside Profiles: aluminium, natural anodized	→ 71 cm ↗ 56 cm ↑ 4 cm	11 kg	649.-	619.-

Preise: UVP exkl. MwSt.
Prix: prix de vente
conseillés hors TVA
Prices: RRP ex. VAT

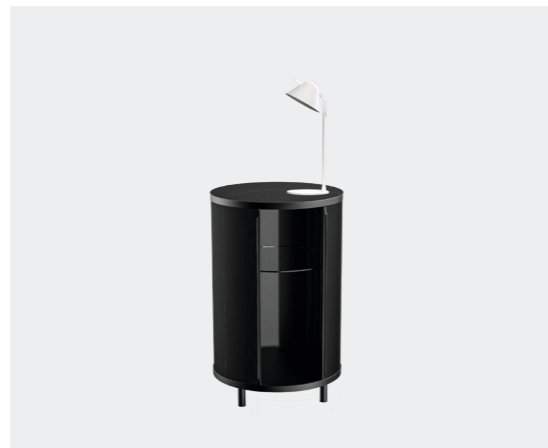

Cylinder D40
(wood)

Design:
Benny Mosimann
2020

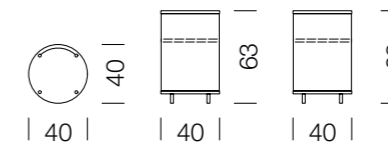

Masse in cm
Dimensions en cm
Dimensions in cm



Bestell-Nr. N° de commande Reference no.	Ausführung, Farbe & Material	Finition, matériau & couleur
	Schieber: Eichenfurnier schwarz Boden: Melamin seidenmatt schwarz Profile: Aluminium schwarz eloxiert Rückwand: Kunststoff (PP) schwarz Fixtablar: Klarglas, d= 33.2 cm h= 0.5 cm Fuss: Aluminium schwarz eloxiert Fusshöhe: 6.5 cm	Portes coulissantes: chêne plaqué noir Base: mélamine noire satinée Profilé: aluminium anodisé noir Panneau arrière: plastique (PP) noir Étagère fixe: verre transparent, d= 33.2 cm h= 0.5 cm Pieds: aluminium anodisé noir Hauteur du pied: 6.5 cm
73-003-221-221-077-014	Abdeckung: Melamin seidenmatt schwarz	Dessus: mélamine noire satinée
73-003-221-571-077-014	Abdeckung: Klarglas schwarz unterlackiert	Dessus: verre transparent au dessous laqué noir
	Schieber: Eichenfurnier weiss Boden: Melamin seidenmatt weiss Profile: Aluminium natur eloxiert Rückwand: Kunststoff (PP) opalweiss Fixtablar: Klarglas, d= 33.2 cm h= 0.5 cm Fuss: Aluminium natur eloxiert Fusshöhe: 6.5 cm	Portes coulissantes: chêne plaqué blanc Base: mélamine blanche satinée Profilé: aluminium anodisé naturel Panneau arrière: plastique (PP) blanc opalin Étagère fixe: verre transparent, d= 33.2 cm h= 0.5 cm Pieds: aluminium anodisé naturel Hauteur du pied: 6.5 cm
73-003-229-229-076-013	Abdeckung: Melamin seidenmatt weiss	Dessus: mélamine blanche satinée
73-003-229-561-076-013	Abdeckung: Klarglas weiss unterlackiert	Dessus: verre transparent au dessous laqué blanc

Finish, material & colour	Verpackungsmasse Dimensions de l'emballage Package dimensions	Gewicht Poids Weight	CHF	EUR
Sliding doors: oak veneer, black Base: melamine, silky matt black Profiles: aluminium, black anodized Back wall: plastic (PP), black Fixed shelf: clear glass, d= 33.2 cm h= 0.5 cm Feet: aluminium, black anodized Foot height: 6.5 cm	→ 47 cm ↗ 47 cm ↑ 66.5 cm			
Cover: melamine, silky matt black		12 kg	1619.-	1549.-
Cover: clear glass, black-lacquered underside		13 kg	1779.-	1699.-
Sliding doors: oak veneer, white Base: melamine, silky matt white Profiles: aluminium, natural anodized Back wall: plastic (PP), opal white Fixed shelf: clear glass, d= 33.2 cm h= 0.5 cm Feet: aluminium, natural anodized Foot height: 6.5 cm	→ 47 cm ↗ 47 cm ↑ 66.5 cm			
Cover: melamine, silky matt white		12 kg	1619.-	1549.-
Cover: clear glass, white-lacquered underside		13 kg	1779.-	1699.-

Preise: UVP exkl. MwSt.
Prix: prix de vente
conseillés hors TVA
Prices: RRP ex. VAT

Bestell-Nr. N° de commande Reference no.	Ausführung, Farbe & Material	Finition, matériau & couleur
	Schieber: Eichenfurnier natur Boden: Melamin seidenmatt schwarz Profil: Aluminium schwarz eloxiert Rückwand: Kunststoff (PP) schwarz Fixtablar: Klarglas, d= 33.2 cm h= 0.5 cm Fuss: Aluminium schwarz eloxiert Fusshöhe: 6.5 cm	Portes coulissantes: chêne plaqué naturel Base: mélamine noire satinée Profilé: aluminium anodisé noir Panneau arrière: plastique (PP) noir Étagère fixe: verre transparent, d= 33.2 cm h= 0.5 cm Pieds: aluminium anodisé noir Hauteur du pied: 6.5 cm
73-003-221-221-075-014	Abdeckung: Melamin seidenmatt schwarz	Dessus: mélamine noire satinée
73-003-221-571-075-014	Abdeckung: Klarglas schwarz unterlackiert	Dessus: verre transparent au dessous laqué noir





	Schieber: Eichenfurnier natur Boden: Melamin seidenmatt weiss Profil: Aluminium natur eloxiert Rückwand: Kunststoff (PP) opalweiss Fixtablar: Klarglas, d= 33.2 cm h= 0.5 cm Fuss: Aluminium natur eloxiert Fusshöhe: 6.5 cm	Portes coulissantes: chêne plaqué naturel Base: mélamine blanche satinée Profilé: aluminium anodisé naturel Panneau arrière: plastique (PP) blanc opalin Étagère fixe: verre transparent, d= 33.2 cm h= 0.5 cm Pieds: aluminium anodisé naturel Hauteur du pied: 6.5 cm
73-003-229-229-075-013	Abdeckung: Melamin seidenmatt weiss	Dessus: mélamine blanche satinée
73-003-229-561-075-013	Abdeckung: Klarglas weiss unterlackiert	Dessus: verre transparent au dessous laqué blanc

Finish, material & colour	Verpackungsmasse Dimensions de l'emballage Package dimensions	Gewicht Poids Weight	CHF	EUR
Sliding doors: oak veneer, natural Base: melamine, silky matt black Profiles: aluminium, black anodized Back wall: plastic (PP), black Fixed shelf: clear glass, d= 33.2 cm h= 0.5 cm Feet: aluminium, black anodized Foot height: 6.5 cm	→ 47 cm ↗ 47 cm ↑ 66.5 cm			
Cover: melamine, silky matt black		12 kg	1619.-	1549.-
Cover: clear glass, black-lacquered underside		13 kg	1779.-	1699.-
Sliding doors: oak veneer, natural Base: melamine, silky matt white Profiles: aluminium, natural anodized Back wall: plastic (PP), opal white Fixed shelf: clear glass, d= 33.2 cm h= 0.5 cm Feet: aluminium, natural anodized Foot height: 6.5 cm	→ 47 cm ↗ 47 cm ↑ 66.5 cm			
Cover: melamine, silky matt white		12 kg	1619.-	1549.-
Cover: clear glass, white-lacquered underside		13 kg	1779.-	1699.-

Bestell-Nr. N° de commande Reference no.	Ausführung, Farbe & Material	Finition, matériau & couleur
	Schieber: Kunststoff (PP) schwarz Boden: Melamin seidenmatt schwarz Profil: Aluminium schwarz eloxiert Rückwand: Kunststoff (PP) schwarz Fixtablar: Klarglas, d= 33.2 cm h= 0.5 cm Fuss: Aluminium schwarz eloxiert Fusshöhe: 6.5 cm	Base: mélamine noire satinée Portes coulissantes: plastique (PP) noir Profilé: aluminium anodisé noir Panneau arrière: plastique (PP) noir Étagère fixe: verre transparent, d= 33.2 cm h= 0.5 cm Pieds: aluminium anodisé noir Hauteur du pied: 6.5 cm
73-003-221-221-071-014	Abdeckung: Melamin seidenmatt schwarz	Dessus: mélamine noire satinée
73-003-221-571-071-014	Abdeckung: Klarglas schwarz unterlackiert	Dessus: verre transparent au dessous laqué noir

	Schieber: Kunststoff (PP) opalweiss Boden: Melamin seidenmatt weiss Profil: Aluminium natur eloxiert Rückwand: Kunststoff (PP) opalweiss Fixtablar: Klarglas, d= 33.2 cm h= 0.5 cm Fuss: Aluminium natur eloxiert Fusshöhe: 6.5 cm	Base: mélamine blanche satinée Portes coulissantes: plastique (PP) blanc opalin Profilé: aluminium anodisé naturel Panneau arrière: plastique (PP) blanc opalin Étagère fixe: verre transparent, d= 33.2 cm h= 0.5 cm Pieds: aluminium anodisé naturel Hauteur du pied: 6.5 cm
73-003-229-229-056-013	Abdeckung: Melamin seidenmatt weiss	Dessus: mélamine blanche satinée
73-003-229-561-056-013	Abdeckung: Klarglas weiss unterlackiert	Dessus: verre transparent au dessous laqué blanc

Finish, material & colour	Verpackungsmasse Dimensions de l'emballage Package dimensions	Gewicht Poids Weight	CHF	EUR
Base: melamine, silky matt black Sliding doors: plastic (PP), black Profiles: aluminium, black anodized Back wall: plastic (PP), black Fixed shelf: clear glass, d= 33.2 cm h= 0.5 cm Feet: aluminium, black anodized Foot height: 6.5 cm	→ 47 cm ↗ 47 cm ↑ 66.5 cm			
Cover: melamine, silky matt black			1299.-	1239.-
Cover: clear glass, black-lacquered underside			1459.-	1389.-
Base: melamine, silky matt white Sliding doors: plastic (PP), opal white Profiles: aluminium, natural anodized Back wall: plastic (PP), opal white Fixed shelf: clear glass, d= 33.2 cm h= 0.5 cm Feet: aluminium, natural anodized Foot height: 6.5 cm	→ 47 cm ↗ 47 cm ↑ 66.5 cm			
Cover: melamine, silky matt white			1299.-	1239.-
Cover: clear glass, white-lacquered underside			1459.-	1389.-

Bestell-Nr. N° de commande Reference no.	Zubehör	Accessoires
	Kabeldurchführung, Farbe: Kunststoff schwarz Durchmesser: 7 cm, Innendurchmesser: 5.5 cm Positionierung: hinten mittig Wahlweise in Deckel / Boden / Abdeckung aus Melamin	Passage de câbles, couleur: plastique noir Diamètre: 7 cm, diamètre intérieur: 5.5 cm Positionnement: arrière central Au choix dans plateau/base/dessus en mélamine
73-012-062		
	Kabeldurchführung, Farbe: Kunststoff weiss Durchmesser: 7 cm, Innendurchmesser: 5.5 cm Positionierung: hinten mittig Wahlweise in Deckel / Boden / Abdeckung aus Melamin	Passage de câbles, couleur: plastique blanc Diamètre: 7 cm, diamètre intérieur: 5.5 cm Positionnement: arrière central Au choix dans plateau/base/dessus en mélamine
73-012-061		
	Glasabdeckplatte, Klarglas schwarz unterlackiert Inkl. Klebeband zum auflegen und aufkleben, auf den bestehenden Deckel (aus Melamin)	Plaque de dessus en verre, verre transparent au dessous laqué noir Avec bande adhésive à poser et à coller sur dessus d'origine (en mélamine)
73-030-571		
	Glasabdeckplatte, Klarglas weiss unterlackiert Inkl. Klebeband zum auflegen und aufkleben, auf den bestehenden Deckel (aus Melamin)	Plaque de dessus en verre, verre transparent au dessous laqué blanc Avec bande adhésive à poser et à coller sur dessus d'origine (en mélamine)
73-030-561		

Accessories	Verpackungsmasse Dimensions de l'emballage Package dimensions	Gewicht Poids Weight	CHF	EUR
Cable grommet, Colour: plastic, black Diameter: 7 cm, Inner diameter: 5.5 cm Positioning: centre back Optional lid / base / cover made of melamine			49.-	49.-
Cable grommet, Colour: plastic, white Diameter: 7 cm, Inner diameter: 5.5 cm Positioning: centre back Optional lid / base / cover made of melamine			49.-	49.-
Glass cover plate, Clear glass, black-lacquered underside Incl. adhesive tape to place and stick on existing lid (made of melamine)	→ 45 cm ↗ 45 cm ↑ 4 cm	4 kg	199.-	189.-
Glass cover plate, Clear glass, white-lacquered underside Incl. adhesive tape to place and stick on existing lid (made of melamine)	→ 45 cm ↗ 45 cm ↑ 4 cm	4 kg	199.-	189.-

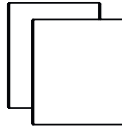
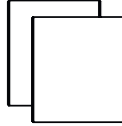
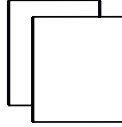
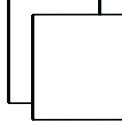
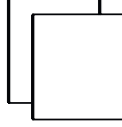
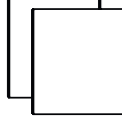
Bestell-Nr. N° de commande Reference no.	Ersatzteile	Pièces de rechange
	Ersatzglastablar Tablar: Klarglas Grösse: d= 33.2 cm h= 0.6 cm	Étagère en verre de rechange Étagère: verre transparent Dimensions: d= 33.2 cm h= 0.6 cm
73-011-551		
	Ersatzschieber, 2 Stück Farbe: Kunststoff (PP) schwarz Grösse: 46.5 x 52.9 cm Profil: Aluminium schwarz eloxiert	Portes coulissantes de rechange, 2 pièces Couleur: plastique (PP) noir Dimensions: 46.5 x 52.9 cm Profilé: aluminium anodisé noir
73-020-071-014		
	Ersatzschieber, 2 Stück Farbe: Kunststoff (PP) opalweiss Grösse: 46.5 x 52.9 cm Profil: Aluminium natur eloxiert	Portes coulissantes de rechange, 2 pièces Couleur: plastique (PP) blanc opalin Dimensions: 46.5 x 52.9 cm Profilé: aluminium anodisé naturel
73-020-056-013		
	Ersatzschieber, 2 Stück Farbe: Eichenfurnier schwarz Grösse: 46.5 x 52.9 cm Profil: Aluminium schwarz eloxiert	Portes coulissantes de rechange, 2 pièces Couleur: chêne plaqué noir Dimensions: 46.5 x 52.9 cm Profilé: aluminium anodisé noir
73-020-077-014		
	Ersatzschieber, 2 Stück Farbe: Eichenfurnier weiss Grösse: 46.5 x 52.9 cm Profil: Aluminium natur eloxiert	Portes coulissantes de rechange, 2 pièces Couleur: chêne plaqué blanc Dimensions: 46.5 x 52.9 cm Profilé: aluminium anodisé naturel
73-020-076-013		
	Ersatzschieber, 2 Stück Farbe: Eichenfurnier natur Grösse: 46.5 x 52.9 cm Profil: Aluminium schwarz eloxiert	Portes coulissantes de rechange, 2 pièces Couleur: chêne plaqué naturel Dimensions: 46.5 x 52.9 cm Profilé: aluminium anodisé noir
73-020-075-014		
	Ersatzschieber, 2 Stück Farbe: Eichenfurnier natur Grösse: 46.5 x 52.9 cm Profil: Aluminium natur eloxiert	Portes coulissantes de rechange, 2 pièces Couleur: chêne plaqué naturel Dimensions: 46.5 x 52.9 cm Profilé: aluminium anodisé naturel
73-020-075-013		

Spare parts	Verpackungsmasse Dimensions de l'emballage Package dimensions	Gewicht Poids Weight	CHF	EUR
Replacement glass shelf Shelf: clear glass Dimensions: d= 33.2 cm h= 0.6 cm	→ 40 cm ↗ 40 cm ↑ 3 cm			
		3 kg	149.-	149.-
Replacement sliding doors, 2 pieces Colour: plastic (PP), black Dimensions: 46.5 x 52.9 cm Profiles: aluminium, black anodized	→ 40 cm ↗ 40 cm ↑ 60 cm			
		2 kg	319.-	309.-
Replacement sliding doors, 2 pieces Colour: plastic (PP), opal white Dimensions: 46.5 x 52.9 cm Profiles: aluminium, natural anodized	→ 40 cm ↗ 40 cm ↑ 60 cm			
		2 kg	319.-	309.-
Replacement sliding doors, 2 pieces Colour: oak veneer, black Dimensions: 46.5 x 52.9 cm Profiles: aluminium, black anodized	→ 40 cm ↗ 40 cm ↑ 60 cm			
		2 kg	549.-	529.-
Replacement sliding doors, 2 pieces Colour: oak veneer, white Dimensions: 46.5 x 52.9 cm Profiles: aluminium, natural anodized	→ 40 cm ↗ 40 cm ↑ 60 cm			
		2 kg	549.-	529.-
Replacement sliding doors, 2 pieces Colour: oak veneer, natural Dimensions: 46.5 x 52.9 cm Profiles: aluminium, black anodized	→ 40 cm ↗ 40 cm ↑ 60 cm			
		2 kg	549.-	529.-
Replacement sliding doors, 2 pieces Colour: oak veneer, natural Dimensions: 46.5 x 52.9 cm Profiles: aluminium, natural anodized	→ 40 cm ↗ 40 cm ↑ 60 cm			
		2 kg	549.-	529.-



Preise: UVP exkl. MwSt.
Prix: prix de vente
conseillés hors TVA
Prices: RRP ex. VAT

wogg 74

**Cylinder D50
(wood)****Design:
Benny Mosimann
2020**

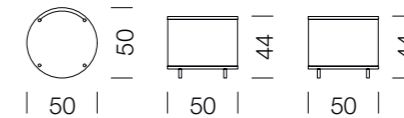
wogg 74

Masse in cm
Dimensions en cm
Dimensions in cm

Bestell-Nr. N° de commande Reference no.	Ausführung, Farbe & Material	Finition, matériau & couleur
	Schieber: Eichenfurnier schwarz Boden: Melamin seidenmatt schwarz Profil: Aluminium schwarz eloxiert Rückwand: Kunststoff (PP) schwarz Fuss: Aluminium schwarz eloxiert Fusshöhe: 6.5 cm	Portes coulissantes: chêne plaqué noir Base: mélamine noire satinée Profilé: aluminium anodisé noir Panneau arrière: plastique (PP) noir Pieds: aluminium anodisé noir Hauteur du pied: 6.5 cm
74-001-221-221-077-014	Abdeckung: Melamin seidenmatt schwarz	Dessus: mélamine noire satinée
74-001-221-571-077-014	Abdeckung: Klarglas schwarz unterlackiert	Dessus: verre transparent au dessous laqué noir
	Schieber: Eichenfurnier weiss Boden: Melamin seidenmatt weiss Profil: Aluminium natur eloxiert Rückwand: Kunststoff (PP) opalweiss Fuss: Aluminium natur eloxiert Fusshöhe: 6.5 cm	Portes coulissantes: chêne plaqué blanc Base: mélamine blanche satinée Profilé: aluminium anodisé naturel Panneau arrière: plastique (PP) blanc opalin Pieds: aluminium anodisé naturel Hauteur du pied: 6.5 cm
74-001-229-229-076-013	Abdeckung: Melamin seidenmatt weiss	Dessus: mélamine blanche satinée
74-001-229-561-076-013	Abdeckung: Klarglas weiss unterlackiert	Dessus: verre transparent au dessous laqué blanc

Finish, material & colour	Verpackungsmasse Dimensions de l'emballage Package dimensions	Gewicht Poids Weight	CHF	EUR
Sliding doors: oak veneer, black Base: melamine, silky matt black Profile: aluminium, black anodized Back wall: plastic (PP), black Feet: aluminium, black anodized Foot height: 6.5 cm	→ 56 cm ↗ 56 cm ↑ 47 cm			
Cover: melamine, silky matt black		12 kg	1349.-	1289.-
Cover: clear glass, black-lacquered underside		16 kg	1519.-	1449.-
Sliding doors: oak veneer, white Base: melamine, silky matt white Profile: aluminium, natural anodized Back wall: plastic (PP), opal white Feet: aluminium, natural anodized Foot height: 6.5 cm	→ 56 cm ↗ 56 cm ↑ 47 cm			
Cover: melamine, silky matt white		12 kg	1349.-	1289.-
Cover: clear glass, white-lacquered underside		16 kg	1519.-	1449.-

Preise: UVP exkl. MwSt.
Prix: prix de vente
conseillés hors TVA
Prices: RRP ex. VAT

Bestell-Nr. N° de commande Reference no.	Ausführung, Farbe & Material	Finition, matériau & couleur
	Schieber: Eichenfurnier natur Boden: Melamin seidenmatt schwarz Profil: Aluminium schwarz eloxiert Rückwand: Kunststoff (PP) schwarz Fuss: Aluminium schwarz eloxiert Fusshöhe: 6.5 cm	Portes coulissantes: chêne plaqué naturel Base: mélamine noire satinée Profilé: aluminium anodisé noir Panneau arrière: plastique (PP) noir Pieds: aluminium anodisé noir Hauteur du pied: 6.5 cm
74-001-221-221-075-014	Abdeckung: Melamin seidenmatt schwarz	Dessus: mélamine noire satinée
74-001-221-571-075-014	Abdeckung: Klarglas schwarz unterlackiert	Dessus: verre transparent au dessous laqué noir

	Schieber: Eichenfurnier natur Boden: Melamin seidenmatt weiss Profil: Aluminium natur eloxiert Rückwand: Kunststoff (PP) opalweiss Fuss: Aluminium natur eloxiert Fusshöhe: 6.5 cm	Portes coulissantes: chêne plaqué naturel Base: mélamine blanche satinée Profilé: aluminium anodisé naturel Panneau arrière: plastique (PP) blanc opalin Pieds: aluminium anodisé naturel Hauteur du pied: 6.5 cm
74-001-229-229-075-013	Abdeckung: Melamin seidenmatt weiss	Dessus: mélamine blanche satinée
74-001-229-561-075-013	Abdeckung: Klarglas weiss unterlackiert	Dessus: verre transparent au dessous laqué blanc

Finish, material & colour	Verpackungsmasse Dimensions de l'emballage Package dimensions	Gewicht Poids Weight	CHF	EUR
Sliding doors: oak veneer, natural Base: melamine, silky matt black Profile: aluminium, black anodized Back wall: plastic (PP), black Feet: aluminium, black anodized Foot height: 6.5 cm	→ 56 cm ↗ 56 cm ↑ 47 cm			
Cover: melamine, silky matt black		12 kg	1349.-	1289.-
Cover: clear glass, black-lacquered underside		16 kg	1519.-	1449.-
Sliding doors: oak veneer, natural Base: melamine, silky matt white Profile: aluminium, natural anodized Back wall: plastic (PP), opal white Feet: aluminium, natural anodized Foot height: 6.5 cm	→ 56 cm ↗ 56 cm ↑ 47 cm			
Cover: melamine, silky matt white		12 kg	1349.-	1289.-
Cover: clear glass, white-lacquered underside		16 kg	1519.-	1449.-

Bestell-Nr. N° de commande Reference no.	Ausführung, Farbe & Material	Finition, matériau & couleur
	Schieber: Kunststoff (PP) schwarz Boden: Melamin seidenmatt schwarz Profil: Aluminium schwarz eloxiert Rückwand: Kunststoff (PP) schwarz Fuss: Aluminium schwarz eloxiert Fusshöhe: 6.5 cm	Portes coulissantes: plastique (PP) noir Base: mélamine noire satinée Profilé: aluminium anodisé noir Panneau arrière: plastique (PP) noir Pieds: aluminium anodisé noir Hauteur du pied: 6.5 cm
74-001-221-221-071-014	Abdeckung: Melamin seidenmatt schwarz	Dessus: mélamine noire satinée
74-001-221-571-071-014	Abdeckung: Klarglas schwarz unterlackiert	Dessus: verre transparent au dessous laqué noir

	Schieber: Kunststoff (PP) opalweiss Boden: Melamin seidenmatt weiss Profil: Aluminium natur eloxiert Rückwand: Kunststoff (PP) opalweiss Fuss: Aluminium natur eloxiert Fusshöhe: 6.5 cm	Portes coulissantes: plastique (PP) blanc opalin Base: mélamine blanche satinée Profilé: aluminium anodisé naturel Panneau arrière: plastique (PP) blanc opalin Pieds: aluminium anodisé naturel Hauteur du pied: 6.5 cm
74-001-229-229-056-013	Abdeckung: Melamin seidenmatt weiss	Dessus: mélamine blanche satinée
74-001-229-561-056-013	Abdeckung: Klarglas weiss unterlackiert	Dessus: verre transparent au dessous laqué blanc

Finish, material & colour	Verpackungsmasse Dimensions de l'emballage Package dimensions	Gewicht Poids Weight	CHF	EUR
Sliding doors: plastic (PP), black Base: melamine, silky matt black Profiles: aluminium, black anodized Back wall: plastic (PP), black Feet: aluminium, black anodized Foot height: 6.5 cm	→ 56 cm ↗ 56 cm ↑ 47 cm			
Cover: melamine, silky matt black		12 kg	1089.-	1039.-
Cover: clear glass, black-lacquered underside		16 kg	1259.-	1199.-
Sliding doors: plastic (PP), opal white Base: melamine, silky matt white Profiles: aluminium, natural anodized Back wall: plastic (PP), opal white Feet: aluminium, natural anodized Foot height: 6.5 cm	→ 56 cm ↗ 56 cm ↑ 47 cm			
Cover: melamine, silky matt white		12 kg	1089.-	1039.-
Cover: clear glass, white-lacquered underside		16 kg	1259.-	1199.-



**Cylinder D50
(wood)**

**Design:
Benny Mosimann
2020**

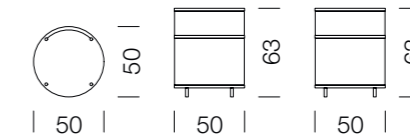

Masse in cm
Dimensions en cm
Dimensions in cm



Bestell-Nr. N° de commande Reference no.	Ausführung, Farbe & Material	Finition, matériau & couleur
	Schieber: Eichenfurnier schwarz Boden: Melamin seidenmatt schwarz Profil: Aluminium schwarz eloxiert Rückwand: Kunststoff (PP) schwarz Fuss: Aluminium schwarz eloxiert Fusshöhe: 6.5 cm	Portes coulissantes: chêne plaqué noir Base: mélamine noire satinée Profilé: aluminium anodisé noir Panneau arrière: plastique (PP) noir Pieds: aluminium anodisé noir Hauteur du pied: 6.5 cm
74-002-221-221-077-014	Abdeckung: Melamin seidenmatt schwarz	Dessus: mélamine noire satinée
74-002-221-571-077-014	Abdeckung: Klarglas schwarz unterlackiert	Dessus: verre transparent au dessous laqué noir
	Schieber: Eichenfurnier weiss Boden: Melamin seidenmatt weiss Profil: Aluminium natur eloxiert Rückwand: Kunststoff (PP) opalweiss Fuss: Aluminium natur eloxiert Fusshöhe: 6.5 cm	Portes coulissantes: chêne plaqué blanc Base: mélamine blanche satinée Profilé: aluminium anodisé naturel Panneau arrière: plastique (PP) blanc opalin Pieds: aluminium anodisé naturel Hauteur du pied: 6.5 cm
74-002-229-229-076-013	Abdeckung: Melamin seidenmatt weiss	Dessus: mélamine blanche satinée
74-002-229-561-076-013	Abdeckung: Klarglas weiss unterlackiert	Dessus: verre transparent au dessous laqué blanc

Finish, material & colour	Verpackungsmasse Dimensions de l'emballage Package dimensions	Gewicht Poids Weight	CHF	EUR
Sliding doors: oak veneer, black Base: melamine, silky matt black Profile: aluminium, black anodized Back wall: plastic (PP), black Feet: aluminium, black anodized Foot height: 6.5 cm	→ 56 cm ↗ 56 cm ↑ 66 cm			
Cover: melamine, silky matt black		14 kg	2049.-	1959.-
Cover: clear glass, black-lacquered underside		18 kg	2219.-	2119.-
Sliding doors: oak veneer, white Base: melamine, silky matt white Profile: aluminium, natural anodized Back wall: plastic (PP), opal white Feet: aluminium, natural anodized Foot height: 6.5 cm	→ 56 cm ↗ 56 cm ↑ 66 cm			
Cover: melamine, silky matt white		14 kg	2049.-	1959.-
Cover: clear glass, white-lacquered underside		18 kg	2219.-	2119.-

Preise: UVP exkl. MwSt.
Prix: prix de vente
conseillés hors TVA
Prices: RRP ex. VAT

Bestell-Nr. N° de commande Reference no.	Ausführung, Farbe & Material	Finition, matériau & couleur
	Schieber: Eichenfurnier natur Boden: Melamin seidenmatt schwarz Profil: Aluminium schwarz eloxiert Rückwand: Kunststoff (PP) schwarz Fuss: Aluminium schwarz eloxiert Fusshöhe: 6.5 cm	Portes coulissantes: chêne plaqué naturel Base: mélamine noire satinée Profilé: aluminium anodisé noir Panneau arrière: plastique (PP) noir Pieds: aluminium anodisé noir Hauteur du pied: 6.5 cm
74-002-221-221-075-014	Abdeckung: Melamin seidenmatt schwarz	Dessus: mélamine noire satinée
74-002-221-571-075-014	Abdeckung: Klarglas schwarz unterlackiert	Dessus: verre transparent au dessous laqué noir

	Schieber: Eichenfurnier natur Boden: Melamin seidenmatt weiss Profil: Aluminium natur eloxiert Rückwand: Kunststoff (PP) opalweiss Fuss: Aluminium natur eloxiert Fusshöhe: 6.5 cm	Portes coulissantes: chêne plaqué naturel Base: mélamine blanche satinée Profilé: aluminium anodisé naturel Panneau arrière: plastique (PP) blanc opalin Pieds: aluminium anodisé naturel Hauteur du pied: 6.5 cm
74-002-229-229-075-013	Abdeckung: Melamin seidenmatt weiss	Dessus: mélamine blanche satinée
74-002-229-561-075-013	Abdeckung: Klarglas weiss unterlackiert	Dessus: verre transparent au dessous laqué blanc



Finish, material & colour	Verpackungsmasse Dimensions de l'emballage Package dimensions	Gewicht Poids Weight	CHF	EUR
Sliding doors: oak veneer, natural Base: melamine, silky matt black Profile: aluminium, black anodized Back wall: plastic (PP), black Feet: aluminium, black anodized Foot height: 6.5 cm	→ 56 cm ↗ 56 cm ↑ 66 cm			
Cover: melamine, silky matt black		14 kg	1919.-	1829.-
Cover: clear glass, black-lacquered underside		18 kg	2089.-	1989.-
Sliding doors: oak veneer, natural Base: melamine, silky matt white Profile: aluminium, natural anodized Back wall: plastic (PP), opal white Feet: aluminium, natural anodized Foot height: 6.5 cm	→ 56 cm ↗ 56 cm ↑ 66 cm			
Cover: melamine, silky matt white		14 kg	2049.-	1959.-
Cover: clear glass, white-lacquered underside		18 kg	2219.-	2119.-

Bestell-Nr. N° de commande Reference no.	Ausführung, Farbe & Material	Finition, matériau & couleur
	Schieber: Kunststoff (PP) schwarz Boden: Melamin seidenmatt schwarz Profil: Aluminium schwarz eloxiert Rückwand: Kunststoff (PP) schwarz Fuss: Aluminium schwarz eloxiert Fusshöhe: 6.5 cm	Portes coulissantes: plastique (PP) noir Base: mélamine noire satinée Profilé: aluminium anodisé noir Panneau arrière: plastique (PP) noir Pieds: aluminium anodisé noir Hauteur du pied: 6.5 cm
74-002-221-221-071-014	Abdeckung: Melamin seidenmatt schwarz	Dessus: mélamine noire satinée
74-002-221-571-071-014	Abdeckung: Klarglas schwarz unterlackiert	Dessus: verre transparent au dessous laqué noir

	Schieber: Kunststoff (PP) opalweiss Boden: Melamin seidenmatt weiss Profil: Aluminium natur eloxiert Rückwand: Kunststoff (PP) opalweiss Fuss: Aluminium natur eloxiert Fusshöhe: 6.5 cm	Portes coulissantes: plastique (PP) blanc opalin Base: mélamine blanche satinée Profilé: aluminium anodisé naturel Panneau arrière: plastique (PP) blanc opalin Pieds: aluminium anodisé naturel Hauteur du pied: 6.5 cm
74-002-229-229-056-013	Abdeckung: Melamin seidenmatt weiss	Dessus: mélamine blanche satinée
74-002-229-561-056-013	Abdeckung: Klarglas weiss unterlackiert	Dessus: verre transparent au dessous laqué blanc

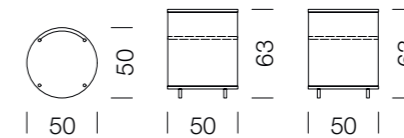
Finish, material & colour	Verpackungsmasse Dimensions de l'emballage Package dimensions	Gewicht Poids Weight	CHF	EUR
Sliding doors: plastic (PP), black Base: melamine, silky matt black Profiles: aluminium, black anodized Back wall: plastic (PP), black Feet: aluminium, black anodized Foot height: 6.5 cm	→ 56 cm ↗ 56 cm ↑ 66 cm			
Cover: melamine, silky matt black		14 kg	1849.-	1769.-
Cover: clear glass, black-lacquered underside		18 kg	2019.-	1929.-
Sliding doors: plastic (PP), opal white Base: melamine, silky matt white Profiles: aluminium, natural anodized Back wall: plastic (PP), opal white Feet: aluminium, natural anodized Foot height: 6.5 cm	→ 56 cm ↗ 56 cm ↑ 66 cm			
Cover: melamine, silky matt white		14 kg	1849.-	1769.-
Cover: clear glass, white-lacquered underside		18 kg	2019.-	1929.-

Design:
Benny Mosimann
2020Masse in cm
Dimensions en cm
Dimensions in cm

Bestell-Nr. N° de commande Reference no.	Ausführung, Farbe & Material	Finition, matériau & couleur
	Schieber: Eichenfurnier schwarz Boden: Melamin seidenmatt schwarz Profil: Aluminium schwarz eloxiert Rückwand: Kunststoff (PP) schwarz Fixtablar: Klarglas, d= 42.8 cm h= 0.5 cm Fuss: Aluminium schwarz eloxiert Fusshöhe: 6.5 cm	Portes coulissantes: chêne plaqué noir Base: mélamine noire satinée Profilé: aluminium anodisé noir Panneau arrière: plastique (PP) noir Étagère fixe: verre transparent, d= 42.8 cm h= 0.5 cm Pieds: aluminium anodisé noir Hauteur du pied: 6.5 cm
74-003-221-221-077-014	Abdeckung: Melamin seidenmatt schwarz	Dessus: mélamine noire satinée
74-003-221-571-077-014	Abdeckung: Klarglas schwarz unterlackiert	Dessus: verre transparent au dessous laqué noir
	Schieber: Eichenfurnier weiss Boden: Melamin seidenmatt weiss Profil: Aluminium natur eloxiert Rückwand: Kunststoff (PP) opalweiss Fixtablar: Klarglas, d= 42.8 cm h= 0.5 cm Fuss: Aluminium natur eloxiert Fusshöhe: 6.5 cm	Portes coulissantes: chêne plaqué blanc Base: mélamine blanche satinée Profilé: aluminium anodisé naturel Panneau arrière: plastique (PP) blanc opalin Étagère fixe: verre transparent, d= 42.8 cm h= 0.5 cm Pieds: aluminium anodisé naturel Hauteur du pied: 6.5 cm
74-003-229-229-076-013	Abdeckung: Melamin seidenmatt weiss	Dessus: mélamine blanche satinée
74-003-229-561-076-013	Abdeckung: Klarglas weiss unterlackiert	Dessus: verre transparent au dessous laqué blanc

Finish, material & colour	Verpackungsmasse Dimensions de l'emballage Package dimensions	Gewicht Poids Weight	CHF	EUR
Sliding doors: oak veneer, black Base: melamine, silky matt black Profile: aluminium, black anodized Back wall: plastic (PP), black Fixed shelf: clear glass, d= 42.8 cm h= 0.5 cm Feet: aluminium, black anodized Foot height: 6.5 cm	→ 56 cm ↗ 56 cm ↑ 66 cm			
Cover: melamine, silky matt black		14 kg	1919.-	1829.-
Cover: clear glass, black-lacquered underside		18 kg	2089.-	1989.-
Sliding doors: oak veneer, white Base: melamine, silky matt white Profile: aluminium, natural anodized Back wall: plastic (PP), opal white Fixed shelf: clear glass, d= 42.8 cm h= 0.5 cm Feet: aluminium, natural anodized Foot height: 6.5 cm	→ 56 cm ↗ 56 cm ↑ 66 cm			
Cover: melamine, silky matt white		14 kg	1919.-	1829.-
Cover: clear glass, white-lacquered underside		18 kg	2089.-	1989.-

Preise: UVP exkl. MwSt.
Prix: prix de vente
conseillés hors TVA
Prices: RRP ex. VAT

Bestell-Nr. N° de commande Reference no.	Ausführung, Farbe & Material	Finition, matériau & couleur
	Schieber: Eichenfurnier natur Boden: Melamin seidenmatt schwarz Profil: Aluminium schwarz eloxiert Rückwand: Kunststoff (PP) schwarz Fixtablar: Klarglas, d= 42.8 cm h= 0.5 cm Fuss: Aluminium schwarz eloxiert Fusshöhe: 6.5 cm	Portes coulissantes: chêne plaqué naturel Base: mélamine noire satinée Profilé: aluminium anodisé noir Panneau arrière: plastique (PP) noir Étagère fixe: verre transparent, d= 42.8 cm h= 0.5 cm Pieds: aluminium anodisé noir Hauteur du pied: 6.5 cm
74-003-221-221-075-014	Abdeckung: Melamin seidenmatt schwarz	Dessus: mélamine noire satinée
74-003-221-571-075-014	Abdeckung: Klarglas schwarz unterlackiert	Dessus: verre transparent au dessous laqué noir



	Schieber: Eichenfurnier natur Boden: Melamin seidenmatt weiss Profil: Aluminium natur eloxiert Rückwand: Kunststoff (PP) opalweiss Fixtablar: Klarglas, d= 42.8 cm h= 0.5 cm Fuss: Aluminium natur eloxiert Fusshöhe: 6.5 cm	Portes coulissantes: chêne plaqué naturel Base: mélamine blanche satinée Profilé: aluminium anodisé naturel Panneau arrière: plastique (PP) blanc opalin Étagère fixe: verre transparent, d= 42.8 cm h= 0.5 cm Pieds: aluminium anodisé naturel Hauteur du pied: 6.5 cm
74-003-229-229-075-013	Abdeckung: Melamin seidenmatt weiss	Dessus: mélamine blanche satinée
74-003-229-561-075-013	Abdeckung: Klarglas weiss unterlackiert	Dessus: verre transparent au dessous laqué blanc

Finish, material & colour	Verpackungsmasse Dimensions de l'emballage Package dimensions	Gewicht Poids Weight	CHF	EUR
Sliding doors: oak veneer, natural Base: melamine, silky matt black Profile: aluminium, black anodized Back wall: plastic (PP), black Fixed shelf: clear glass, d= 42.8 cm h= 0.5 cm Feet: aluminium, black anodized Foot height: 6.5 cm	→ 56 cm ↗ 56 cm ↑ 66 cm			
Cover: melamine, silky matt black		14 kg	1919.-	1829.-
Cover: clear glass, black-lacquered underside		18 kg	2089.-	1989.-
Sliding doors: oak veneer, natural Base: melamine, silky matt white Profile: aluminium, natural anodized Back wall: plastic (PP), opal white Fixed shelf: clear glass, d= 42.8 cm h= 0.5 cm Feet: aluminium, natural anodized Foot height: 6.5 cm	→ 56 cm ↗ 56 cm ↑ 66 cm			
Cover: melamine, silky matt white		14 kg	1919.-	1829.-
Cover: clear glass, white-lacquered underside		18 kg	2089.-	1989.-



Bestell-Nr. N° de commande Reference no.	Ausführung, Farbe & Material	Finition, matériau & couleur
	Schieber: Kunststoff (PP) schwarz Boden: Melamin seidenmatt schwarz Profil: Aluminium schwarz eloxiert Rückwand: Kunststoff (PP) schwarz Fixtablar: Klarglas, d= 42.8 cm h= 0.5 cm Fuss: Aluminium schwarz eloxiert Fusshöhe: 6.5 cm	Portes coulissantes: plastique (PP) noir Base: mélamine noire satinée Profilé: aluminium anodisé noir Panneau arrière: plastique (PP) noir Étagère fixe: verre transparent, d= 42.8 cm h= 0.5 cm Pieds: aluminium anodisé noir Hauteur du pied: 6.5 cm
74-003-221-221-071-014	Abdeckung: Melamin seidenmatt schwarz	Dessus: mélamine noire satinée
74-003-221-571-071-014	Abdeckung: Klarglas schwarz unterlackiert	Dessus: verre transparent au dessous laqué noir

	Schieber: Kunststoff (PP) opalweiss Boden: Melamin seidenmatt weiss Profil: Aluminium natur eloxiert Rückwand: Kunststoff (PP) opalweiss Fixtablar: Klarglas, d= 42.8 cm h= 0.5 cm Fuss: Aluminium natur eloxiert Fusshöhe: 6.5 cm	Portes coulissantes: plastique (PP) blanc opalin Base: mélamine blanche satinée Profilé: aluminium anodisé naturel Panneau arrière: plastique (PP) blanc opalin Étagère fixe: verre transparent, d= 42.8 cm h= 0.5 cm Pieds: aluminium anodisé naturel Hauteur du pied: 6.5 cm
74-003-229-229-056-013	Abdeckung: Melamin seidenmatt weiss	Dessus: mélamine blanche satinée
74-003-229-561-056-013	Abdeckung: Klarglas weiss unterlackiert	Dessus: verre transparent au dessous laqué blanc

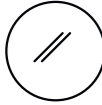
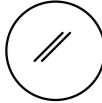
Finish, material & colour	Verpackungsmasse Dimensions de l'emballage Package dimensions	Gewicht Poids Weight	CHF	EUR
Sliding doors: plastic (PP), black Base: melamine, silky matt black Profiles: aluminium, black anodized Back wall: plastic (PP), black Fixed shelf: clear glass, d= 42.8 cm h= 0.5 cm Feet: aluminium, black anodized Foot height: 6.5 cm	→ 56 cm ↗ 56 cm ↑ 66 cm			
Cover: melamine, silky matt black		14 kg	1699.-	1619.-
Cover: clear glass, black-lacquered underside		18 kg	1869.-	1789.-
Sliding doors: plastic (PP), opal white Base: melamine, silky matt white Profiles: aluminium, natural anodized Back wall: plastic (PP), opal white Fixed shelf: clear glass, d= 42.8 cm h= 0.5 cm Feet: aluminium, natural anodized Foot height: 6.5 cm	→ 56 cm ↗ 56 cm ↑ 66 cm			
Cover: melamine, silky matt white		14 kg	1699.-	1619.-
Cover: clear glass, white-lacquered underside		18 kg	1869.-	1789.-



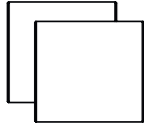
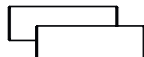
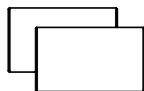
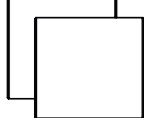

Bestell-Nr. N° de commande Reference no.	Zubehör	Accessoires
	Kabeldurchführung, Farbe: Kunststoff schwarz Durchmesser: 7 cm, Innendurchmesser: 5.5 cm Polistionierung: hinten mittig Wahlweise in Deckel / Boden / Abdeckung aus Melamin	Passage de câbles, couleur: plastique noir Diamètre: 7 cm, diamètre intérieur: 5.5 cm Positionnement: arrière central Au choix dans plateau/base/dessus en mélamine
73-012-062		
	Kabeldurchführung, Farbe: Kunststoff weiss Durchmesser: 7 cm, Innendurchmesser: 5.5 cm Polistionierung: hinten mittig Wahlweise in Deckel / Boden / Abdeckung aus Melamin	Passage de câbles, couleur: plastique blanc Diamètre: 7 cm, diamètre intérieur: 5.5 cm Positionnement: arrière central Au choix dans plateau/base/dessus en mélamine
74-012-061		
	Glasabdeckplatte, Klarglas schwarz unterlackiert Inkl. Klebeband zum auflegen und aufkleben, auf den bestehenden Deckel (aus Melamin)	Plaque de dessus en verre, verre transparent au dessous laqué noir Avec bande adhésive à poser et à coller sur dessus d'origine (en mélamine)
74-030-571		
	Glasabdeckplatte, Klarglas weiss unterlackiert Inkl. Klebeband zum auflegen und aufkleben, auf den bestehenden Deckel (aus Melamin)	Plaque de dessus en verre, verre transparent au dessous laqué blanc Avec bande adhésive à poser et à coller sur dessus d'origine (en mélamine)
74-030-561		

Accessories	Verpackungsmasse Dimensions de l'emballage Package dimensions	Gewicht Poids Weight	CHF	EUR
Cable grommet, Colour: plastic, black Diameter: 7 cm, Inner diameter: 5.5 cm Positioning: centre back Optional lid / base / cover made of melamine			49.-	49.-
Cable grommet, Colour: plastic, white Diameter: 7 cm, Inner diameter: 5.5 cm Positioning: centre back Optional lid / base / cover made of melamine			49.-	49.-
Glass cover plate, Clear glass, black-lacquered underside Incl. adhesive tape to place and stick on existing lid (made of melamine)	→ 55 cm ↗ 55 cm ↑ 4 cm	5 kg	219.-	209.-
Glass cover plate, Clear glass, white-lacquered underside Incl. adhesive tape to place and stick on existing lid (made of melamine)	→ 55 cm ↗ 55 cm ↑ 4 cm	5 kg	219.-	209.-

Bestell-Nr. N° de commande Reference no.	Ersatzteile	Pièces de rechange
	Ersatzglastablar Tablar: Klarglas Grösse: d= 42.8 cm h= 0.6 cm	Étagère en verre de rechange Étagère: verre transparent Dimensions: d= 42.8 cm h= 0.6 cm
74-011-551		
	Ersatzschieber schmal, 2 Stück Farbe: Kunststoff (PP) schwarz Grösse: 57.5 x 17.8 cm Profil: Aluminium schwarz eloxiert	Petites portes coulissantes de rechange, 2 pièces Couleur: plastique (PP) noir Dimensions: 57.5 x 17.8 cm Profilé: aluminium anodisé noir
74-020-071-014-S		
	Ersatzschieber hoch, 2 Stück Farbe: Kunststoff (PP) schwarz Grösse: 57.5 x 33.7 cm Profil: Aluminium schwarz eloxiert	Grandes portes coulissantes de rechange, 2 pièces Couleur: plastique (PP) noir Dimensions: 57.5 x 33.7 cm Profilé: aluminium anodisé noir
74-020-071-014-H		
	Ersatzschieber ganze Höhe, 2 Stück Farbe: Kunststoff (PP) schwarz Grösse: 57.5 x 52.9 cm Profil: Aluminium schwarz eloxiert	Portes coulissantes de rechange hauteur totale, 2 pièces Couleur: plastique (PP) noir Dimensions: 57.5 x 52.9 cm Profilé: aluminium anodisé noir
74-020-071-014-G		
	Ersatzschieber schmal, 2 Stück Farbe: Kunststoff (PP) opalweiss Grösse: 57.5 x 17.8 cm Profil: Aluminium natur eloxiert	Petites portes coulissantes de rechange, 2 pièces Couleur: plastique (PP) blanc opalin Dimensions: 57.5 x 17.8 cm Profilé: aluminium anodisé naturel
74-020-056-013-S		
	Ersatzschieber hoch, 2 Stück Farbe: Kunststoff (PP) opalweiss Grösse: 57.5 x 33.7 cm Profil: Aluminium natur eloxiert	Grandes portes coulissantes de rechange, 2 pièces Couleur: plastique (PP) blanc opalin Dimensions: 57.5 x 33.7 cm Profilé: aluminium anodisé naturel
74-020-056-013-H		
	Ersatzschieber ganze Höhe, 2 Stück Farbe: Kunststoff (PP) opalweiss Grösse: 57.5 x 52.9 cm Profil: Aluminium natur eloxiert	Portes coulissantes de rechange hauteur totale, 2 pièces Couleur: plastique (PP) blanc opalin Dimensions: 57.5 x 52.9 cm Profilé: aluminium anodisé naturel
74-020-056-013-G		

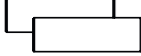
Spare parts	Verpackungsmasse Dimensions de l'emballage Package dimensions	Gewicht Poids Weight	CHF	EUR
Replacement glass shelf Shelf: clear glass Dimensions: d= 42.8 cm h= 0.6 cm	→ 50 cm ↗ 50 cm ↑ 3 cm			
		3 kg	159.-	159.-
Replacement sliding doors, slim, 2 pieces Colour: plastic (PP), black Dimensions: 57.5 x 17.8 cm Profiles: aluminium, black anodized	→ 40 cm ↗ 40 cm ↑ 40 cm			
		2 kg	199.-	189.-
Replacement sliding doors, high, 2 pieces Colour: plastic (PP), black Dimensions: 57.5 x 33.7 cm Profiles: aluminium, black anodized	→ 40 cm ↗ 40 cm ↑ 40 cm			
		2 kg	299.-	289.-
Replacement sliding doors, full height, 2 pieces Colour: plastic (PP), black Dimensions: 57.5 x 52.9 cm Profiles: aluminium, black anodized	→ 40 cm ↗ 40 cm ↑ 60 cm			
		2 kg	329.-	319.-
Replacement sliding doors, slim, 2 pieces Colour: plastic (PP), opal white Dimensions: 57.5 x 17.8 cm Profiles: aluminium, natural anodized	→ 40 cm ↗ 40 cm ↑ 40 cm			
		2 kg	199.-	189.-
Replacement sliding doors, high, 2 pieces Colour: plastic (PP), opal white Dimensions: 57.5 x 33.7 cm Profiles: aluminium, natural anodized	→ 40 cm ↗ 40 cm ↑ 40 cm			
		2 kg	299.-	289.-
Replacement sliding doors, full height, 2 pieces Colour: plastic (PP), opal white Dimensions: 57.5 x 52.9 cm Profiles: aluminium, natural anodized	→ 40 cm ↗ 40 cm ↑ 60 cm			
		2 kg	329.-	319.-

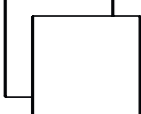
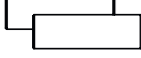
Preise: UVP exkl. MwSt.
Prix: prix de vente
conseillés hors TVA
Prices: RRP ex. VAT

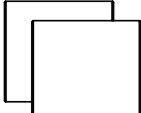
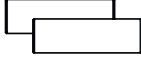
Bestell-Nr. N° de commande Reference no.	Ersatzteile	Pièces de rechange
	Ersatzschieber natur schmal, 2 Stück Farbe: Eichenfurnier natur Grösse: 57.5 x 17.8 cm Profil: Aluminium natur eloxiert	Petites portes coulissantes de rechange, 2 pièces Couleur: chêne plaqué naturel Dimensions: 57.5 x 17.8 cm Profilé: aluminium anodisé naturel
74-020-075-013-S		
	Ersatzschieber natur hoch, 2 Stück Farbe: Eichenfurnier natur Grösse: 57.5 x 33.7 cm Profil: Aluminium natur eloxiert	Grandes portes coulissantes de rechange, 2 pièces Couleur: chêne plaqué naturel Dimensions: 57.5 x 33.7 cm Profilé: aluminium anodisé naturel
74-020-075-013-H		
	Ersatzschieber natur ganze Höhe, 2 Stück Farbe: Eichenfurnier natur Grösse: 57.5 x 52.9 cm Profil: Aluminium natur eloxiert	Portes coulissantes de rechange hauteur totale, 2 pièces Couleur: chêne plaqué naturel Dimensions: 57.5 x 52.9 cm Profilé: aluminium anodisé naturel
74-020-075-013-G		
	Ersatzschieber natur schmal, 2 Stück Farbe: Eichenfurnier weiss Grösse: 57.5 x 17.8 cm Profil: Aluminium natur eloxiert	Petites portes coulissantes de rechange, 2 pièces Couleur: chêne plaqué blanc Dimensions: 57.5 x 17.8 cm Profilé: aluminium anodisé naturel
74-020-076-013-S		
	Ersatzschieber natur hoch, 2 Stück Farbe: Eichenfurnier weiss Grösse: 57.5 x 33.7 cm Profil: Aluminium natur eloxiert	Grandes portes coulissantes de rechange, 2 pièces Couleur: chêne plaqué blanc Dimensions: 57.5 x 33.7 cm Profilé: aluminium anodisé naturel
74-020-076-013-H		
	Ersatzschieber natur ganze Höhe, 2 Stück Farbe: Eichenfurnier weiss Grösse: 57.5 x 52.9 cm Profil: Aluminium natur eloxiert	Portes coulissantes de rechange hauteur totale, 2 pièces Couleur: chêne plaqué blanc Dimensions: 57.5 x 52.9 cm Profilé: aluminium anodisé naturel
74-020-076-013-G		
	Ersatzschieber natur schmal, 2 Stück Farbe: Eichenfurnier schwarz Grösse: 57.5 x 17.8 cm Profil: Aluminium natur eloxiert	Petites portes coulissantes de rechange, 2 pièces Couleur: chêne plaqué noir Dimensions: 57.5 x 17.8 cm Profilé: aluminium anodisé naturel
74-020-077-014-S		

Spare parts	Verpackungsmasse Dimensions de l'emballage Package dimensions	Gewicht Poids Weight	CHF	EUR
Replacement sliding doors, slim, 2 pieces Colour: oak veneer, natural Dimensions: 57.5 x 17.8 cm Profiles: aluminium, natural anodized	→ 40 cm ↗ 40 cm ↑ 40 cm	2 kg	449.-	429.-
Replacement sliding doors, high, 2 pieces Colour: oak veneer, natural Dimensions: 57.5 x 33.7 cm Profiles: aluminium, natural anodized	→ 40 cm ↗ 40 cm ↑ 40 cm	2 kg	519.-	499.-
Replacement sliding doors, full height, 2 pieces Colour: oak veneer, natural Dimensions: 57.5 x 52.9 cm Profiles: aluminium, natural anodized	→ 40 cm ↗ 40 cm ↑ 60 cm	2 kg	599.-	579.-
Replacement sliding doors, slim, 2 pieces Colour: oak veneer, white Dimensions: 57.5 x 17.8 cm Profiles: aluminium, natural anodized	→ 40 cm ↗ 40 cm ↑ 40 cm	2 kg	449.-	429.-
Replacement sliding doors, high, 2 pieces Colour: oak veneer, white Dimensions: 57.5 x 33.7 cm Profiles: aluminium, natural anodized	→ 40 cm ↗ 40 cm ↑ 40 cm	2 kg	519.-	499.-
Replacement sliding doors, full height, 2 pieces Colour: oak veneer, white Dimensions: 57.5 x 52.9 cm Profiles: aluminium, natural anodized	→ 40 cm ↗ 40 cm ↑ 60 cm	2 kg	599.-	579.-
Replacement sliding doors, slim, 2 pieces Colour: oak veneer, black Dimensions: 57.5 x 17.8 cm Profiles: aluminium, natural anodized	→ 40 cm ↗ 40 cm ↑ 40 cm	2 kg	449.-	429.-

Preise: UVP exkl. MwSt.
Prix: prix de vente
conseillés hors TVA
Prices: RRP ex. VAT

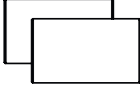
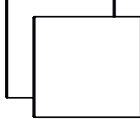
Bestell-Nr. N° de commande Reference no.	Ersatzteile	Pièces de rechange
	Ersatzschieber natur hoch, 2 Stück Farbe: Eichenfurnier schwarz Grösse: 57.5 x 33.7 cm Profil: Aluminium natur eloxiert	Grandes portes coulissantes de rechange, 2 pièces Couleur: chêne plaqué noir Dimensions: 57.5 x 33.7 cm Profilé: aluminium anodisé naturel
74-020-077-014-H		
	Ersatzschieber natur ganze Höhe, 2 Stück Farbe: Eichenfurnier schwarz Grösse: 57.5 x 52.9 cm Profil: Aluminium natur eloxiert	Portes coulissantes de rechange hauteur totale, 2 pièces Couleur: chêne plaqué noir Dimensions: 57.5 x 52.9 cm Profilé: aluminium anodisé naturel
74-020-077-014-G		

Spare parts	Verpackungsmasse Dimensions de l'emballage Package dimensions	Gewicht Poids Weight	CHF	EUR
Replacement sliding doors, high, 2 pieces Colour: oak veneer, black Dimensions: 57.5 x 33.7 cm Profiles: aluminium, natural anodized	→ 40 cm ↗ 40 cm ↑ 40 cm			
		2 kg	519.-	499.-
Replacement sliding doors, full height, 2 pieces Colour: oak veneer, black Dimensions: 57.5 x 52.9 cm Profiles: aluminium, natural anodized	→ 40 cm ↗ 40 cm ↑ 60 cm			
		2 kg	599.-	579.-



Pillar box tray

Design:
Hans Eichenberger
1994

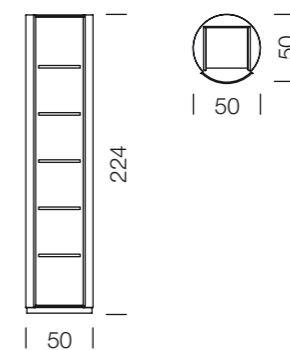

Masse in cm
Dimensions en cm
Dimensions in cm





Bestell-Nr. N° de commande Reference no.	Ausführung, Farbe & Material	Finition, matériau & couleur
	Mantel: Stahlblech pulverbeschichtet jetblack 5 x Tablar höhenverstellbar Mindestraumhöhe: 234 cm	Enveloppe cylindrique: tôle d'acier revêtue par poudre jetblack 5 étagères réglables en hauteur Hauteur minimale de la pièce: 234 cm
13-002-218-451	Korpus: HPL schwarz, Innen: Stahlblech schwarz	Corps intérieur: HPL noir, intérieur: tôle d'acier noire
13-002-299-451	Korpus: HPL weiss, Innen: Stahlblech weiss	Corps intérieur: HPL blanc, intérieur: tôle d'acier blanche
	Mantel: Stahlblech pulverbeschichtet traffic white 5 x Tablar höhenverstellbar Mindestraumhöhe: 234 cm	Enveloppe cylindrique: tôle d'acier revêtue par poudre traffic white 5 étagères réglables en hauteur Hauteur minimale de la pièce: 234 cm
13-002-218-453	Korpus: HPL schwarz, Innen: Stahlblech schwarz	Corps intérieur: HPL noir, intérieur: tôle d'acier noire
13-002-299-453	Korpus: HPL weiss, Innen: Stahlblech weiss	Corps intérieur: HPL blanc, intérieur: tôle d'acier blanche

Finish, material & colour	Verpackungsmasse Dimensions de l'emballage Package dimensions	Gewicht Poids Weight	CHF	EUR
Shell: sheet steel, powder-coated jetblack 5x shelves, height adjustable Minimum room height: 234 cm	→ 58 cm ↗ 55 cm ↑ 228 cm			
Base unit: HPL, black, Interior: Sheet steel, black		59 kg	3629.-	3459.-
Base unit: HPL, white, Interior: Sheet steel, white		59 kg	3629.-	3459.-
Shell: sheet steel, powder-coated traffic white 5x shelves, height adjustable Minimum room height: 234 cm	→ 58 cm ↗ 55 cm ↑ 228 cm			
Base unit: HPL, black, Interior: Sheet steel, black		59 kg	3629.-	3459.-
Base unit: HPL, white, Interior: Sheet steel, white		59 kg	3629.-	3459.-

Preise: UVP exkl. MwSt.
Prix: prix de vente
conseillés hors TVA
Prices: RRP ex. VAT



Bestell-Nr. N° de commande Reference no.	Ausführung, Farbe & Material	Finition, matériau & couleur
	Mantel: Stahlblech pulverbeschichtet stonegrey 5 x Tablar höhenverstellbar Mindestraumhöhe: 234 cm	Enveloppe cylindrique: tôle d'acier revêtue par poudre stonegrey 5 étagères réglables en hauteur Hauteur minimale de la pièce: 234 cm
13-002-218-454	Korpus: HPL schwarz, Innen: Stahlblech schwarz	Corps intérieur: HPL noir, intérieur: tôle d'acier noire
13-002-299-454	Korpus: HPL weiss, Innen: Stahlblech weiss	Corps intérieur: HPL blanc, intérieur: tôle d'acier blanche

	Mantel: Stahlblech pulverbeschichtet morning tea 5 x Tablar höhenverstellbar Mindestraumhöhe: 234 cm	Enveloppe cylindrique: tôle d'acier revêtue par poudre morning tea 5 étagères réglables en hauteur Hauteur minimale de la pièce: 234 cm
13-002-218-459	Korpus: HPL schwarz, Innen: Stahlblech schwarz	Corps intérieur: HPL noir, intérieur: tôle d'acier noire
13-002-299-459	Korpus: HPL weiss, Innen: Stahlblech weiss	Corps intérieur: HPL blanc, intérieur: tôle d'acier blanche

	Mantel: Stahlblech pulverbeschichtet saffron 5 x Tablar höhenverstellbar Mindestraumhöhe: 234 cm	Enveloppe cylindrique: tôle d'acier revêtue par poudre saffron 5 étagères réglables en hauteur Hauteur minimale de la pièce: 234 cm
13-002-218-462	Korpus: HPL schwarz, Innen: Stahlblech schwarz	Corps intérieur: HPL noir, intérieur: tôle d'acier noire
13-002-299-462	Korpus: HPL weiss, Innen: Stahlblech weiss	Corps intérieur: HPL blanc, intérieur: tôle d'acier blanche



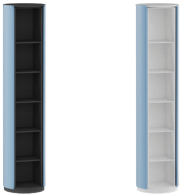

Finish, material & colour	Verpackungsmasse Dimensions de l'emballage Package dimensions	Gewicht Poids Weight	CHF	EUR
Shell: sheet steel, powder-coated stonegrey 5x shelves, height adjustable Minimum room height: 234 cm	→ 58 cm ↗ 55 cm ↑ 228 cm			
Base unit: HPL, black, Interior: Sheet steel, black		59 kg	3629.-	3459.-
Base unit: HPL, white, Interior: Sheet steel, white		59 kg	3629.-	3459.-
Shell: sheet steel, powder-coated morning tea 5x shelves, height adjustable Minimum room height: 234 cm	→ 58 cm ↗ 55 cm ↑ 228 cm			
Base unit: HPL, black, Interior: Sheet steel, black		59 kg	3629.-	3459.-
Base unit: HPL, white, Interior: Sheet steel, white		59 kg	3629.-	3459.-
Shell: sheet steel, powder-coated saffron 5x shelves, height adjustable Minimum room height: 234 cm	→ 58 cm ↗ 55 cm ↑ 228 cm			
Base unit: HPL, black, Interior: Sheet steel, black		59 kg	3629.-	3459.-
Base unit: HPL, white, Interior: Sheet steel, white		59 kg	3629.-	3459.-

Preise: UVP exkl. MwSt.
Prix: prix de vente
conseillés hors TVA
Prices: RRP ex. VAT

Bestell-Nr. N° de commande Reference no.	Ausführung, Farbe & Material	Finition, matériau & couleur
	Mantel: Stahlblech pulverbeschichtet olive 5 x Tablar höhenverstellbar Mindestraumhöhe: 234 cm	Enveloppe cylindrique: tôle d'acier revêtue par poudre olive 5 étagères réglables en hauteur Hauteur minimale de la pièce: 234 cm
13-002-218-466	Korpus: HPL schwarz, Innen: Stahlblech schwarz	Corps intérieur: HPL noir, intérieur: tôle d'acier noire
13-002-299-466	Korpus: HPL weiss, Innen: Stahlblech weiss	Corps intérieur: HPL blanc, intérieur: tôle d'acier blanche
	Mantel: Stahlblech pulverbeschichtet sky blue 5 x Tablar höhenverstellbar Mindestraumhöhe: 234 cm	Enveloppe cylindrique: tôle d'acier revêtue par poudre sky blue 5 étagères réglables en hauteur Hauteur minimale de la pièce: 234 cm
13-002-218-467	Korpus: HPL schwarz, Innen: Stahlblech schwarz	Corps intérieur: HPL noir, intérieur: tôle d'acier noire
13-002-299-467	Korpus: HPL weiss, Innen: Stahlblech weiss	Corps intérieur: HPL blanc, intérieur: tôle d'acier blanche
	Mantel: Stahlblech pulverbeschichtet light grey 5 x Tablar höhenverstellbar Mindestraumhöhe: 234 cm	Enveloppe cylindrique: tôle d'acier revêtue par poudre light grey 5 étagères réglables en hauteur Hauteur minimale de la pièce: 234 cm
13-002-218-468	Korpus: HPL schwarz, Innen: Stahlblech schwarz	Corps intérieur: HPL noir, intérieur: tôle d'acier noire
13-002-299-468	Korpus: HPL weiss, Innen: Stahlblech weiss	Corps intérieur: HPL blanc, intérieur: tôle d'acier blanche

Finish, material & colour	Verpackungsmasse Dimensions de l'emballage Package dimensions	Gewicht Poids Weight	CHF	EUR
Shell: sheet steel, powder-coated olive 5x shelves, height adjustable Minimum room height: 234 cm	→ 58 cm ↗ 55 cm ↑ 228 cm			
Base unit: HPL, black, Interior: Sheet steel, black		59 kg	3629.-	3459.-
Base unit: HPL, white, Interior: Sheet steel, white		59 kg	3629.-	3459.-
Shell: sheet steel, powder-coated sky blue 5x shelves, height adjustable Minimum room height: 234 cm	→ 58 cm ↗ 55 cm ↑ 228 cm			
Base unit: HPL, black, Interior: Sheet steel, black		59 kg	3629.-	3459.-
Base unit: HPL, white, Interior: Sheet steel, white		59 kg	3629.-	3459.-
Shell: sheet steel, powder-coated light grey 5x shelves, height adjustable Minimum room height: 234 cm	→ 58 cm ↗ 55 cm ↑ 228 cm			
Base unit: HPL, black, Interior: Sheet steel, black		59 kg	3629.-	3459.-
Base unit: HPL, white, Interior: Sheet steel, white		59 kg	3629.-	3459.-

Preise: UVP exkl. MwSt.
Prix: prix de vente
conseillés hors TVA
Prices: RRP ex. VAT

Bestell-Nr. N° de commande Reference no.	Ausführung, Farbe & Material	Finition, matériau & couleur
 	Mantel: Stahlblech pulverbeschichtet gold 5 x Tablar höhenverstellbar Mindestraumhöhe: 234 cm	Enveloppe cylindrique: tôle d'acier revêtue par poudre gold 5 étagères réglables en hauteur Hauteur minimale de la pièce: 234 cm
13-002-218-041	Korpus: HPL schwarz, Innen: Stahlblech schwarz	Corps intérieur: HPL noir, intérieur: tôle d'acier noire
13-002-299-041	Korpus: HPL weiss, Innen: Stahlblech weiss	Corps intérieur: HPL blanc, intérieur: tôle d'acier blanche
 	Mantel: Stahlblech pulverbeschichtet Sonderfarbe RAL/NCS 5 x Tablar höhenverstellbar Mindestraumhöhe: 234 cm	Enveloppe cylindrique: tôle d'acier revêtue par poudre couleur spéciale RAL/NCS 5 étagères réglables en hauteur Hauteur minimale de la pièce: 234 cm
13-002-218-500	Korpus: HPL schwarz, Innen: Stahlblech schwarz	Corps intérieur: HPL noir, intérieur: tôle d'acier noire
13-002-299-500	Korpus: HPL weiss, Innen: Stahlblech weiss	Corps intérieur: HPL blanc, intérieur: tôle d'acier blanche



Finish, material & colour	Verpackungsmasse Dimensions de l'emballage Package dimensions	Gewicht Poids Weight	CHF	EUR
Shell: sheet steel, powder-coated gold 5x shelves, height adjustable Minimum room height: 234 cm	→ 58 cm ↗ 55 cm ↑ 228 cm			
Base unit: HPL, black, Interior: Sheet steel, black		59 kg	3629.-	3459.-
Base unit: HPL, white, Interior: Sheet steel, white		59 kg	3629.-	3459.-
Shell: sheet steel, powder-coated custom RAL/NCS colour 5x shelves, height adjustable Minimum room height: 234 cm	→ 58 cm ↗ 55 cm ↑ 228 cm			
Base unit: HPL, black, Interior: Sheet steel, black		59 kg	4429.-	4219.-
Base unit: HPL, white, Interior: Sheet steel, white		59 kg	4429.-	4219.-

Preise: UVP exkl. MwSt.
Prix: prix de vente
conseillés hors TVA
Prices: RRP ex. VAT

Pillar box display

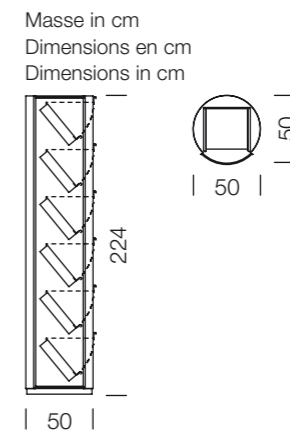

Design:
Hans Eichenberger
1994



Bestell-Nr. N° de commande Reference no.	Ausführung, Farbe & Material	Finition, matériau & couleur
	Mantel: Stahlblech pulverbeschichtet jetblack 6 x Schrägfächer (inkl. Tablare) Mindestraumhöhe: 234 cm	Enveloppe cylindrique: tôle d'acier revêtue par poudre jetblack 6 présentoirs inclinés (étagères comprises) Hauteur minimale de la pièce: 234 cm
13-003-218-451	Korpus: HPL schwarz, Innen: Stahlblech schwarz	Corps intérieur: HPL noir, intérieur: tôle d'acier noire
13-003-299-451	Korpus: HPL weiss, Innen: Stahlblech weiss	Corps intérieur: HPL blanc, intérieur: tôle d'acier blanche
	Mantel: Stahlblech pulverbeschichtet traffic white 6 x Schrägfächer (inkl. Tablare) Mindestraumhöhe: 234 cm	Enveloppe cylindrique: tôle d'acier revêtue par poudre traffic white 6 présentoirs inclinés (étagères comprises) Hauteur minimale de la pièce: 234 cm
13-003-218-453	Korpus: HPL schwarz, Innen: Stahlblech schwarz	Corps intérieur: HPL noir, intérieur: tôle d'acier noire
13-003-299-453	Korpus: HPL weiss, Innen: Stahlblech weiss	Corps intérieur: HPL blanc, intérieur: tôle d'acier blanche

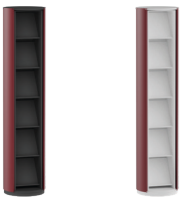

Finish, material & colour	Verpackungsmasse Dimensions de l'emballage Package dimensions	Gewicht Poids Weight	CHF	EUR
Shell: sheet steel, powder-coated jetblack 6x slanted display surfaces (incl. shelves) Minimum room height: 234 cm	→ 58 cm ↗ 55 cm ↑ 228 cm			
Base unit: HPL, black, Interior: Sheet steel, black		59 kg	4299.-	4099.-
Base unit: HPL, white, Interior: Sheet steel, white		59 kg	4299.-	4099.-
Shell: sheet steel, powder-coated traffic white 6x slanted display surfaces (incl. shelves) Minimum room height: 234 cm	→ 58 cm ↗ 55 cm ↑ 228 cm			
Base unit: HPL, black, Interior: Sheet steel, black		59 kg	4299.-	4099.-
Base unit: HPL, white, Interior: Sheet steel, white		59 kg	4299.-	4099.-

Preise: UVP exkl. MwSt.
Prix: prix de vente
conseillés hors TVA
Prices: RRP ex. VAT

Bestell-Nr. N° de commande Reference no.	Ausführung, Farbe & Material	Finition, matériau & couleur
	Mantel: Stahlblech pulverbeschichtet stonegrey 6 x Schrägfächer (inkl. Tablare) Mindestraumhöhe: 234 cm	Enveloppe cylindrique: tôle d'acier revêtue par poudre stonegrey 6 présentoirs inclinés (étagères comprises) Hauteur minimale de la pièce: 234 cm
13-003-218-454	Korpus: HPL schwarz, Innen: Stahlblech schwarz	Corps intérieur: HPL noir, intérieur: tôle d'acier noire
13-003-299-454	Korpus: HPL weiss, Innen: Stahlblech weiss	Corps intérieur: HPL blanc, intérieur: tôle d'acier blanche
	Mantel: Stahlblech pulverbeschichtet morning tea 6 x Schrägfächer (inkl. Tablare) Mindestraumhöhe: 234 cm	Enveloppe cylindrique: tôle d'acier revêtue par poudre morning tea 6 présentoirs inclinés (étagères comprises) Hauteur minimale de la pièce: 234 cm
13-003-218-459	Korpus: HPL schwarz, Innen: Stahlblech schwarz	Corps intérieur: HPL noir, intérieur: tôle d'acier noire
13-003-299-459	Korpus: HPL weiss, Innen: Stahlblech weiss	Corps intérieur: HPL blanc, intérieur: tôle d'acier blanche
	Mantel: Stahlblech pulverbeschichtet saffron 6 x Schrägfächer (inkl. Tablare) Mindestraumhöhe: 234 cm	Enveloppe cylindrique: tôle d'acier revêtue par poudre saffron 6 présentoirs inclinés (étagères comprises) Hauteur minimale de la pièce: 234 cm
13-003-218-462	Korpus: HPL schwarz, Innen: Stahlblech schwarz	Corps intérieur: HPL noir, intérieur: tôle d'acier noire
13-003-299-462	Korpus: HPL weiss, Innen: Stahlblech weiss	Corps intérieur: HPL blanc, intérieur: tôle d'acier blanche

Finish, material & colour	Verpackungsmasse Dimensions de l'emballage Package dimensions	Gewicht Poids Weight	CHF	EUR
Shell: sheet steel, powder-coated stonegrey 6x slanted display surfaces (incl. shelves) Minimum room height: 234 cm	→ 58 cm ↗ 55 cm ↑ 228 cm			
Base unit: HPL, black, Interior: Sheet steel, black		59 kg	4299.-	4099.-
Base unit: HPL, white, Interior: Sheet steel, white		59 kg	4299.-	4099.-
Shell: sheet steel, powder-coated morning tea 6x slanted display surfaces (incl. shelves) Minimum room height: 234 cm	→ 58 cm ↗ 55 cm ↑ 228 cm			
Base unit: HPL, black, Interior: Sheet steel, black		59 kg	4299.-	4099.-
Base unit: HPL, white, Interior: Sheet steel, white		59 kg	4299.-	4099.-
Shell: sheet steel, powder-coated saffron 6x slanted display surfaces (incl. shelves) Minimum room height: 234 cm	→ 58 cm ↗ 55 cm ↑ 228 cm			
Base unit: HPL, black, Interior: Sheet steel, black		59 kg	4299.-	4099.-
Base unit: HPL, white, Interior: Sheet steel, white		59 kg	4299.-	4099.-

Preise: UVP exkl. MwSt.
Prix: prix de vente
conseillés hors TVA
Prices: RRP ex. VAT

Bestell-Nr. N° de commande Reference no.	Ausführung, Farbe & Material	Finition, matériau & couleur
	Mantel: Stahlblech pulverbeschichtet olive 6 x Schrägfächer (inkl. Tablare) Mindestraumhöhe: 234 cm	Enveloppe cylindrique: tôle d'acier revêtue par poudre olive 6 présentoirs inclinés (étagères comprises) Hauteur minimale de la pièce: 234 cm
13-003-218-466	Korpus: HPL schwarz, Innen: Stahlblech schwarz	Corps intérieur: HPL noir, intérieur: tôle d'acier noire
13-003-299-466	Korpus: HPL weiss, Innen: Stahlblech weiss	Corps intérieur: HPL blanc, intérieur: tôle d'acier blanche
	Mantel: Stahlblech pulverbeschichtet sky blue 6 x Schrägfächer (inkl. Tablare) Mindestraumhöhe: 234 cm	Enveloppe cylindrique: tôle d'acier revêtue par poudre sky blue 6 présentoirs inclinés (étagères comprises) Hauteur minimale de la pièce: 234 cm
13-003-218-467	Korpus: HPL schwarz, Innen: Stahlblech schwarz	Corps intérieur: HPL noir, intérieur: tôle d'acier noire
13-003-299-467	Korpus: HPL weiss, Innen: Stahlblech weiss	Corps intérieur: HPL blanc, intérieur: tôle d'acier blanche
	Mantel: Stahlblech pulverbeschichtet light grey 6 x Schrägfächer (inkl. Tablare) Mindestraumhöhe: 234 cm	Enveloppe cylindrique: tôle d'acier revêtue par poudre light grey 6 présentoirs inclinés (étagères comprises) Hauteur minimale de la pièce: 234 cm
13-003-218-468	Korpus: HPL schwarz, Innen: Stahlblech schwarz	Corps intérieur: HPL noir, intérieur: tôle d'acier noire
13-003-299-468	Korpus: HPL weiss, Innen: Stahlblech weiss	Corps intérieur: HPL blanc, intérieur: tôle d'acier blanche

Finish, material & colour	Verpackungsmasse Dimensions de l'emballage Package dimensions	Gewicht Poids Weight	CHF	EUR
Shell: sheet steel, powder-coated olive 6x slanted display surfaces (incl. shelves) Minimum room height: 234 cm	→ 58 cm ↗ 55 cm ↑ 228 cm			
Base unit: HPL, black, Interior: Sheet steel, black		59 kg	4299.-	4099.-
Base unit: HPL, white, Interior: Sheet steel, white		59 kg	4299.-	4099.-
Shell: sheet steel, powder-coated sky blue 6x slanted display surfaces (incl. shelves) Minimum room height: 234 cm	→ 58 cm ↗ 55 cm ↑ 228 cm			
Base unit: HPL, black, Interior: Sheet steel, black		59 kg	4299.-	4099.-
Base unit: HPL, white, Interior: Sheet steel, white		59 kg	4299.-	4099.-
Shell: sheet steel, powder-coated light grey 6x slanted display surfaces (incl. shelves) Minimum room height: 234 cm	→ 58 cm ↗ 55 cm ↑ 228 cm			
Base unit: HPL, black, Interior: Sheet steel, black		59 kg	4299.-	4099.-
Base unit: HPL, white, Interior: Sheet steel, white		59 kg	4299.-	4099.-

Preise: UVP exkl. MwSt.
Prix: prix de vente
conseillés hors TVA
Prices: RRP ex. VAT

Bestell-Nr. N° de commande Reference no.	Ausführung, Farbe & Material	Finition, matériau & couleur
	Mantel: Stahlblech pulverbeschichtet gold 6 x Schrägfächer (inkl. Tablare) Mindestraumhöhe: 234 cm	Enveloppe cylindrique: tôle d'acier revêtue par poudre gold 6 présentoirs inclinés (étagères comprises) Hauteur minimale de la pièce: 234 cm
13-003-218-041	Korpus: HPL schwarz, Innen: Stahlblech schwarz	Corps intérieur: HPL noir, intérieur: tôle d'acier noire
13-003-299-041	Korpus: HPL weiss, Innen: Stahlblech weiss	Corps intérieur: HPL blanc, intérieur: tôle d'acier blanche

	Mantel: Stahlblech pulverbeschichtet Sonderfarbe RAL/NCS 6 x Schrägfächer (inkl. Tablare) Mindestraumhöhe: 234 cm	Enveloppe cylindrique: tôle d'acier revêtue par poudre couleur spéciale RAL/NCS 6 présentoirs inclinés (étagères comprises) Hauteur minimale de la pièce: 234 cm
13-003-218-500	Korpus: HPL schwarz, Innen: Stahlblech schwarz	Corps intérieur: HPL noir, intérieur: tôle d'acier noire
13-003-299-500	Korpus: HPL weiss, Innen: Stahlblech weiss	Corps intérieur: HPL blanc, intérieur: tôle d'acier blanche

Finish, material & colour	Verpackungsmasse Dimensions de l'emballage Package dimensions	Gewicht Poids Weight	CHF	EUR
Shell: sheet steel, powder-coated gold 6x slanted display surfaces (incl. shelves) Minimum room height: 234 cm	→ 58 cm ↗ 55 cm ↑ 228 cm			
Base unit: HPL, black, Interior: Sheet steel, black		59 kg	4299.-	4099.-
Base unit: HPL, white, Interior: Sheet steel, white		59 kg	4299.-	4099.-
Shell: sheet steel, powder-coated custom RAL/NCS colour 6x slanted display surfaces (incl. shelves) Minimum room height: 234 cm	→ 58 cm ↗ 55 cm ↑ 228 cm			
Base unit: HPL, black, Interior: Sheet steel, black		59 kg	5099.-	4859.-
Base unit: HPL, white, Interior: Sheet steel, white		59 kg	5099.-	4859.-

Preise: UVP exkl. MwSt.
Prix: prix de vente
conseillés hors TVA
Prices: RRP ex. VAT



Pillar box drawer (2)

Design:
Hans Eichenberger
1994



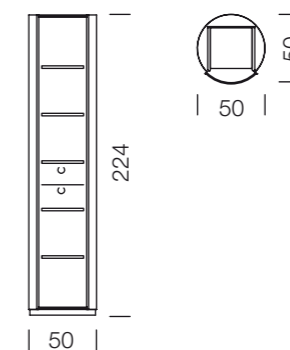

Masse in cm
Dimensions en cm
Dimensions in cm







Bestell-Nr. N° de commande Reference no.	Ausführung, Farbe & Material	Finition, matériau & couleur
	 <p>Mantel: Stahlblech pulverbeschichtet jetblack 5 x Tablare höhenverstellbar 2 x Schubladen H15 Fix montiert im 3. Fach von unten Mindestraumhöhe: 234 cm</p>	<p>Enveloppe cylindrique: tôle d'acier revêtue par poudre jetblack 5 étagères réglables en hauteur 2 tiroirs H15 Montage fixe dans le 3e compartiment en partant du bas Hauteur minimale de la pièce: 234 cm</p>
13-004-218-451	Korpus: HPL schwarz, Innen: Stahlblech schwarz	Corps intérieur: HPL noir, intérieur: tôle d'acier noire
13-004-299-451	Korpus: HPL weiss, Innen: Stahlblech weiss	Corps intérieur: HPL blanc, intérieur: tôle d'acier blanche
	 <p>Mantel: Stahlblech pulverbeschichtet traffic white 5 x Tablare höhenverstellbar 2 x Schubladen H15 Fix montiert im 3. Fach von unten Mindestraumhöhe: 234 cm</p>	<p>Enveloppe cylindrique: tôle d'acier revêtue par poudre traffic white 5 étagères réglables en hauteur 2 tiroirs H15 Montage fixe dans le 3e compartiment en partant du bas Hauteur minimale de la pièce: 234 cm</p>
13-004-218-453	Korpus: HPL schwarz, Innen: Stahlblech schwarz	Corps intérieur: HPL noir, intérieur: tôle d'acier noire
13-004-299-453	Korpus: HPL weiss, Innen: Stahlblech weiss	Corps intérieur: HPL blanc, intérieur: tôle d'acier blanche

Finish, material & colour	Verpackungsmasse Dimensions de l'emballage Package dimensions	Gewicht Poids Weight	CHF	EUR
<p>Shell: sheet steel, powder-coated jetblack 5x shelves, height adjustable 2x drawers H15 Fixed position: third shelf from the bottom Minimum room height: 234 cm</p>	<p>→ 58 cm ↗ 55 cm ↑ 228 cm</p>			
Base unit: HPL, black, Interior: Sheet steel, black		59 kg	4429.-	4219.-
Base unit: HPL, white, Interior: Sheet steel, white		59 kg	4429.-	4219.-
<p>Shell: sheet steel, powder-coated traffic white 5x shelves, height adjustable 2x drawers H15 Fixed position: third shelf from the bottom Minimum room height: 234 cm</p>	<p>→ 58 cm ↗ 55 cm ↑ 228 cm</p>			
Base unit: HPL, black, Interior: Sheet steel, black		59 kg	4429.-	4219.-
Base unit: HPL, white, Interior: Sheet steel, white		59 kg	4429.-	4219.-







Preise: UVP exkl. MwSt.
Prix: prix de vente
conseillés hors TVA
Prices: RRP ex. VAT

Bestell-Nr. N° de commande Reference no.	Ausführung, Farbe & Material	Finition, matériau & couleur
 	Mantel: Stahlblech pulverbeschichtet stonegrey 5 x Tablare höhenverstellbar 2 x Schubladen H15 Fix montiert im 3. Fach von unten Mindestraumhöhe: 234 cm	Enveloppe cylindrique: tôle d'acier revêtue par poudre stonegrey 5 étagères réglables en hauteur 2 tiroirs H15 Montage fixe dans le 3e compartiment en partant du bas Hauteur minimale de la pièce: 234 cm
13-004-218-454	Korpus: HPL schwarz, Innen: Stahlblech schwarz	Corps intérieur: HPL noir, intérieur: tôle d'acier noire
13-004-299-454	Korpus: HPL weiss, Innen: Stahlblech weiss	Corps intérieur: HPL blanc, intérieur: tôle d'acier blanche





 	Mantel: Stahlblech pulverbeschichtet morning tea 5 x Tablare höhenverstellbar 2 x Schubladen H15 Fix montiert im 3. Fach von unten Mindestraumhöhe: 234 cm	Enveloppe cylindrique: tôle d'acier revêtue par poudre morning tea 5 étagères réglables en hauteur 2 tiroirs H15 Montage fixe dans le 3e compartiment en partant du bas Hauteur minimale de la pièce: 234 cm
13-004-218-459	Korpus: HPL schwarz, Innen: Stahlblech schwarz	Corps intérieur: HPL noir, intérieur: tôle d'acier noire
13-004-299-459	Korpus: HPL weiss, Innen: Stahlblech weiss	Corps intérieur: HPL blanc, intérieur: tôle d'acier blanche

 	Mantel: Stahlblech pulverbeschichtet saffron 5 x Tablare höhenverstellbar 2 x Schubladen H15 Fix montiert im 3. Fach von unten Mindestraumhöhe: 234 cm	Enveloppe cylindrique: tôle d'acier revêtue par poudre saffron 5 étagères réglables en hauteur 2 tiroirs H15 Montage fixe dans le 3e compartiment en partant du bas Hauteur minimale de la pièce: 234 cm
13-004-218-462	Korpus: HPL schwarz, Innen: Stahlblech schwarz	Corps intérieur: HPL noir, intérieur: tôle d'acier noire
13-004-299-462	Korpus: HPL weiss, Innen: Stahlblech weiss	Corps intérieur: HPL blanc, intérieur: tôle d'acier blanche

Finish, material & colour	Verpackungsmasse Dimensions de l'emballage Package dimensions	Gewicht Poids Weight	CHF	EUR
Shell: sheet steel, powder-coated stonegrey 5x shelves, height adjustable 2x drawers H15 Fixed position: third shelf from the bottom Minimum room height: 234 cm	→ 58 cm ↗ 55 cm ↑ 228 cm			
Base unit: HPL, black, Interior: Sheet steel, black		59 kg	4429.-	4219.-
Base unit: HPL, white, Interior: Sheet steel, white		59 kg	4429.-	4219.-
Shell: sheet steel, powder-coated morning tea 5x shelves, height adjustable 2x drawers H15 Fixed position: third shelf from the bottom Minimum room height: 234 cm	→ 58 cm ↗ 55 cm ↑ 228 cm			
Base unit: HPL, black, Interior: Sheet steel, black		59 kg	4429.-	4219.-
Base unit: HPL, white, Interior: Sheet steel, white		59 kg	4429.-	4219.-
Shell: sheet steel, powder-coated saffron 5x shelves, height adjustable 2x drawers H15 Fixed position: third shelf from the bottom Minimum room height: 234 cm	→ 58 cm ↗ 55 cm ↑ 228 cm			
Base unit: HPL, black, Interior: Sheet steel, black		59 kg	4429.-	4219.-
Base unit: HPL, white, Interior: Sheet steel, white		59 kg	4429.-	4219.-

Bestell-Nr. N° de commande Reference no.	Ausführung, Farbe & Material	Finition, matériau & couleur
 	Mantel: Stahlblech pulverbeschichtet olive 5 x Tablare höhenverstellbar 2 x Schubladen H15 Fix montiert im 3. Fach von unten Mindestraumhöhe: 234 cm	Enveloppe cylindrique: tôle d'acier revêtue par poudre olive 5 étagères réglables en hauteur 2 tiroirs H15 Montage fixe dans le 3e compartiment en partant du bas Hauteur minimale de la pièce: 234 cm
13-004-218-466	Korpus: HPL schwarz, Innen: Stahlblech schwarz	Corps intérieur: HPL noir, intérieur: tôle d'acier noire
13-004-299-466	Korpus: HPL weiss, Innen: Stahlblech weiss	Corps intérieur: HPL blanc, intérieur: tôle d'acier blanche
 	Mantel: Stahlblech pulverbeschichtet sky blue 5 x Tablare höhenverstellbar 2 x Schubladen H15 Fix montiert im 3. Fach von unten Mindestraumhöhe: 234 cm	Enveloppe cylindrique: tôle d'acier revêtue par poudre sky blue 5 étagères réglables en hauteur 2 tiroirs H15 Montage fixe dans le 3e compartiment en partant du bas Hauteur minimale de la pièce: 234 cm
13-004-218-467	Korpus: HPL schwarz, Innen: Stahlblech schwarz	Corps intérieur: HPL noir, intérieur: tôle d'acier noire
13-004-299-467	Korpus: HPL weiss, Innen: Stahlblech weiss	Corps intérieur: HPL blanc, intérieur: tôle d'acier blanche
 	Mantel: Stahlblech pulverbeschichtet light grey 5 x Tablare höhenverstellbar 2 x Schubladen H15 Fix montiert im 3. Fach von unten Mindestraumhöhe: 234 cm	Enveloppe cylindrique: tôle d'acier revêtue par poudre light grey 5 étagères réglables en hauteur 2 tiroirs H15 Montage fixe dans le 3e compartiment en partant du bas Hauteur minimale de la pièce: 234 cm
13-004-218-468	Korpus: HPL schwarz, Innen: Stahlblech schwarz	Corps intérieur: HPL noir, intérieur: tôle d'acier noire
13-004-299-468	Korpus: HPL weiss, Innen: Stahlblech weiss	Corps intérieur: HPL blanc, intérieur: tôle d'acier blanche

Finish, material & colour	Verpackungsmasse Dimensions de l'emballage Package dimensions	Gewicht Poids Weight	CHF	EUR
Shell: sheet steel, powder-coated olive 5x shelves, height adjustable 2x drawers H15 Fixed position: third shelf from the bottom Minimum room height: 234 cm	→ 58 cm ↗ 55 cm ↑ 228 cm			
Base unit: HPL, black, Interior: Sheet steel, black		59 kg	4429.-	4219.-
Base unit: HPL, white, Interior: Sheet steel, white		59 kg	4429.-	4219.-
Shell: sheet steel, powder-coated sky blue 5x shelves, height adjustable 2x drawers H15 Fixed position: third shelf from the bottom Minimum room height: 234 cm	→ 58 cm ↗ 55 cm ↑ 228 cm			
Base unit: HPL, black, Interior: Sheet steel, black		59 kg	4429.-	4219.-
Base unit: HPL, white, Interior: Sheet steel, white		59 kg	4429.-	4219.-
Shell: sheet steel, powder-coated light grey 5x shelves, height adjustable 2x drawers H15 Fixed position: third shelf from the bottom Minimum room height: 234 cm	→ 58 cm ↗ 55 cm ↑ 228 cm			
Base unit: HPL, black, Interior: Sheet steel, black		59 kg	4429.-	4219.-
Base unit: HPL, white, Interior: Sheet steel, white		59 kg	4429.-	4219.-

Bestell-Nr. N° de commande Reference no.	Ausführung, Farbe & Material	Finition, matériau & couleur
 	Mantel: Stahlblech pulverbeschichtet gold 5 x Ablare höhenverstellbar 2 x Schubladen H15 Fix montiert im 3. Fach von unten Mindestraumhöhe: 234 cm	Enveloppe cylindrique: tôle d'acier revêtue par poudre gold 5 étagères réglables en hauteur 2 tiroirs H15 Montage fixe dans le 3e compartiment en partant du bas Hauteur minimale de la pièce: 234 cm
13-004-218-041	Korpus: HPL schwarz, Innen: Stahlblech schwarz	Corps intérieur: HPL noir, intérieur: tôle d'acier noire
13-004-299-041	Korpus: HPL weiss, Innen: Stahlblech weiss	Corps intérieur: HPL blanc, intérieur: tôle d'acier blanche
 	Mantel: Stahlblech pulverbeschichtet Sonderfarbe RAL/NCS 5 x Ablare höhenverstellbar 2 x Schubladen H15 Fix montiert im 3. Fach von unten Mindestraumhöhe: 234 cm	Enveloppe cylindrique: tôle d'acier revêtue par poudre couleur spéciale RAL/NCS 5 étagères réglables en hauteur 2 tiroirs H15 Montage fixe dans le 3e compartiment en partant du bas Hauteur minimale de la pièce: 234 cm
13-004-218-500	Korpus: HPL schwarz, Innen: Stahlblech schwarz	Corps intérieur: HPL noir, intérieur: tôle d'acier noire
13-004-299-500	Korpus: HPL weiss, Innen: Stahlblech weiss	Corps intérieur: HPL blanc, intérieur: tôle d'acier blanche

Finish, material & colour	Verpackungsmasse Dimensions de l'emballage Package dimensions	Gewicht Poids Weight	CHF	EUR
Shell: sheet steel, powder-coated gold 5x shelves, height adjustable 2x drawers H15 Fixed position: third shelf from the bottom Minimum room height: 234 cm	→ 58 cm ↗ 55 cm ↑ 228 cm			
Base unit: HPL, black, Interior: Sheet steel, black		59 kg	4429.-	4219.-
Base unit: HPL, white, Interior: Sheet steel, white		59 kg	4429.-	4219.-
Shell: sheet steel, powder-coated custom RAL/NCS colour 5x shelves, height adjustable 2x drawers H15 Fixed position: third shelf from the bottom Minimum room height: 234 cm	→ 58 cm ↗ 55 cm ↑ 228 cm			
Base unit: HPL, black, Interior: Sheet steel, black		59 kg	5229.-	4989.-
Base unit: HPL, white, Interior: Sheet steel, white		59 kg	5229.-	4989.-





Pillar box drawer (4)

Design:
Hans Eichenberger
1994

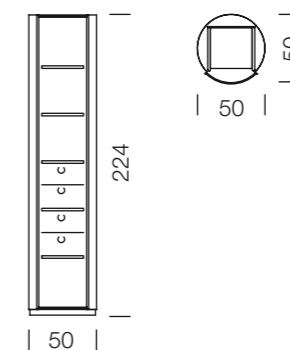







Masse in cm
Dimensions en cm
Dimensions in cm



Bestell-Nr. N° de commande Reference no.	Ausführung, Farbe & Material	Finition, matériau & couleur
 	Mantel: Stahlblech pulverbeschichtet jetblack Innenausstattung: 5 x Tablar höhenverstellbar 4 x Schublade H15 Fix montiert im 2. und 3. Fach von unten Mindestraumhöhe 234 cm	Enveloppe cylindrique: tôle d'acier revêtue par poudre jetblack 5 étagères réglables en hauteur 4 tiroirs H15 Montage fixe dans les 2e et 3e compartiments en partant du bas Hauteur minimale de la pièce: 234 cm
13-005-218-451	Korpus: HPL schwarz, Innen: Stahlblech schwarz	Corps intérieur: HPL noir, intérieur: tôle d'acier noire
13-005-299-451	Korpus: HPL weiss, Innen: Stahlblech weiss	Corps intérieur: HPL blanc, intérieur: tôle d'acier blanche
 	Mantel: Stahlblech pulverbeschichtet traffic white Innenausstattung: 5 x Tablar höhenverstellbar 4 x Schublade H15 Fix montiert im 2. und 3. Fach von unten Mindestraumhöhe 234 cm	Enveloppe cylindrique: tôle d'acier revêtue par poudre traffic white 5 étagères réglables en hauteur 4 tiroirs H15 Montage fixe dans les 2e et 3e compartiments en partant du bas Hauteur minimale de la pièce: 234 cm
13-005-218-453	Korpus: HPL schwarz, Innen: Stahlblech schwarz	Corps intérieur: HPL noir, intérieur: tôle d'acier noire
13-005-299-453	Korpus: HPL weiss, Innen: Stahlblech weiss	Corps intérieur: HPL blanc, intérieur: tôle d'acier blanche





Finish, material & colour	Verpackungsmasse Dimensions de l'emballage Package dimensions	Gewicht Poids Weight	CHF	EUR
Shell: sheet steel, powder-coated jetblack 5x shelves, height adjustable 4x drawers H15 Fixed position: second and third shelf from the bottom Minimum room height: 234 cm	→ 58 cm ↗ 55 cm ↑ 228 cm			
Base unit: HPL, black, Interior: Sheet steel, black		59 kg	5299.-	5049.-
Base unit: HPL, white, Interior: Sheet steel, white		59 kg	5299.-	5049.-
Shell: sheet steel, powder-coated traffic white 5x shelves, height adjustable 4x drawers H15 Fixed position: second and third shelf from the bottom Minimum room height: 234 cm	→ 58 cm ↗ 55 cm ↑ 228 cm			
Base unit: HPL, black, Interior: Sheet steel, black		59 kg	5299.-	5049.-
Base unit: HPL, white, Interior: Sheet steel, white		59 kg	5299.-	5049.-

Preise: UVP exkl. MwSt.
Prix: prix de vente
conseillés hors TVA
Prices: RRP ex. VAT

Bestell-Nr. N° de commande Reference no.	Ausführung, Farbe & Material	Finition, matériau & couleur
 	Mantel: Stahlblech pulverbeschichtet stonegrey Innenausstattung: 5 x Tablar höhenverstellbar 4 x Schublade H15 Fix montiert im 2. und 3. Fach von unten Mindestraumhöhe 234 cm	Enveloppe cylindrique: tôle d'acier revêtue par poudre stonegrey 5 étagères réglables en hauteur 4 tiroirs H15 Montage fixe dans les 2e et 3e compartiments en partant du bas Hauteur minimale de la pièce: 234 cm
13-005-218-454	Korpus: HPL schwarz, Innen: Stahlblech schwarz	Corps intérieur: HPL noir, intérieur: tôle d'acier noire
13-005-299-454	Korpus: HPL weiss, Innen: Stahlblech weiss	Corps intérieur: HPL blanc, intérieur: tôle d'acier blanche
 	Mantel: Stahlblech pulverbeschichtet morning tea Innenausstattung: 5 x Tablar höhenverstellbar 4 x Schublade H15 Fix montiert im 2. und 3. Fach von unten Mindestraumhöhe 234 cm	Enveloppe cylindrique: tôle d'acier revêtue par poudre morning tea 5 étagères réglables en hauteur 4 tiroirs H15 Montage fixe dans les 2e et 3e compartiments en partant du bas Hauteur minimale de la pièce: 234 cm
13-005-218-459	Korpus: HPL schwarz, Innen: Stahlblech schwarz	Corps intérieur: HPL noir, intérieur: tôle d'acier noire
13-005-299-459	Korpus: HPL weiss, Innen: Stahlblech weiss	Corps intérieur: HPL blanc, intérieur: tôle d'acier blanche
 	Mantel: Stahlblech pulverbeschichtet saffron Innenausstattung: 5 x Tablar höhenverstellbar 4 x Schublade H15 Fix montiert im 2. und 3. Fach von unten Mindestraumhöhe 234 cm	Enveloppe cylindrique: tôle d'acier revêtue par poudre saffron 5 étagères réglables en hauteur 4 tiroirs H15 Montage fixe dans les 2e et 3e compartiments en partant du bas Hauteur minimale de la pièce: 234 cm
13-005-218-462	Korpus: HPL schwarz, Innen: Stahlblech schwarz	Corps intérieur: HPL noir, intérieur: tôle d'acier noire
13-005-299-462	Korpus: HPL weiss, Innen: Stahlblech weiss	Corps intérieur: HPL blanc, intérieur: tôle d'acier blanche





Finish, material & colour	Verpackungsmasse Dimensions de l'emballage Package dimensions	Gewicht Poids Weight	CHF	EUR
Shell: sheet steel, powder-coated stonegrey 5x shelves, height adjustable 4x drawers H15 Fixed position: second and third shelf from the bottom Minimum room height: 234 cm	→ 58 cm ↗ 55 cm ↑ 228 cm			
Base unit: HPL, black, Interior: Sheet steel, black		59 kg	5299.-	5049.-
Base unit: HPL, white, Interior: Sheet steel, white		59 kg	5299.-	5049.-
Shell: sheet steel, powder-coated morning tea 5x shelves, height adjustable 4x drawers H15 Fixed position: second and third shelf from the bottom Minimum room height: 234 cm	→ 58 cm ↗ 55 cm ↑ 228 cm			
Base unit: HPL, black, Interior: Sheet steel, black		59 kg	5299.-	5049.-
Base unit: HPL, white, Interior: Sheet steel, white		59 kg	5299.-	5049.-
Shell: sheet steel, powder-coated saffron 5x shelves, height adjustable 4x drawers H15 Fixed position: second and third shelf from the bottom Minimum room height: 234 cm	→ 58 cm ↗ 55 cm ↑ 228 cm			
Base unit: HPL, black, Interior: Sheet steel, black		59 kg	5299.-	5049.-
Base unit: HPL, white, Interior: Sheet steel, white		59 kg	5299.-	5049.-

Preise: UVP exkl. MwSt.
Prix: prix de vente
conseillés hors TVA
Prices: RRP ex. VAT

Bestell-Nr. N° de commande Reference no.	Ausführung, Farbe & Material	Finition, matériau & couleur
 	Mantel: Stahlblech pulverbeschichtet olive Innenausstattung: 5 x Tablar höhenverstellbar 4 x Schublade H15 Fix montiert im 2. und 3. Fach von unten Mindestraumhöhe 234 cm	Enveloppe cylindrique: tôle d'acier revêtue par poudre olive 5 étagères réglables en hauteur 4 tiroirs H15 Montage fixe dans les 2e et 3e compartiments en partant du bas Hauteur minimale de la pièce: 234 cm
13-005-218-466	Korpus: HPL schwarz, Innen: Stahlblech schwarz	Corps intérieur: HPL noir, intérieur: tôle d'acier noire
13-005-299-466	Korpus: HPL weiss, Innen: Stahlblech weiss	Corps intérieur: HPL blanc, intérieur: tôle d'acier blanche
 	Mantel: Stahlblech pulverbeschichtet sky blue Innenausstattung: 5 x Tablar höhenverstellbar 4 x Schublade H15 Fix montiert im 2. und 3. Fach von unten Mindestraumhöhe 234 cm	Enveloppe cylindrique: tôle d'acier revêtue par poudre sky blue 5 étagères réglables en hauteur 4 tiroirs H15 Montage fixe dans les 2e et 3e compartiments en partant du bas Hauteur minimale de la pièce: 234 cm
13-005-218-467	Korpus: HPL schwarz, Innen: Stahlblech schwarz	Corps intérieur: HPL noir, intérieur: tôle d'acier noire
13-005-299-467	Korpus: HPL weiss, Innen: Stahlblech weiss	Corps intérieur: HPL blanc, intérieur: tôle d'acier blanche
 	Mantel: Stahlblech pulverbeschichtet light grey Innenausstattung: 5 x Tablar höhenverstellbar 4 x Schublade H15 Fix montiert im 2. und 3. Fach von unten Mindestraumhöhe 234 cm	Enveloppe cylindrique: tôle d'acier revêtue par poudre light grey 5 étagères réglables en hauteur 4 tiroirs H15 Montage fixe dans les 2e et 3e compartiments en partant du bas Hauteur minimale de la pièce: 234 cm
13-005-218-468	Korpus: HPL schwarz, Innen: Stahlblech schwarz	Corps intérieur: HPL noir, intérieur: tôle d'acier noire
13-005-299-468	Korpus: HPL weiss, Innen: Stahlblech weiss	Corps intérieur: HPL blanc, intérieur: tôle d'acier blanche

Finish, material & colour	Verpackungsmasse Dimensions de l'emballage Package dimensions	Gewicht Poids Weight	CHF	EUR
Shell: sheet steel, powder-coated olive 5x shelves, height adjustable 4x drawers H15 Fixed position: second and third shelf from the bottom Minimum room height: 234 cm	→ 58 cm ↗ 55 cm ↑ 228 cm			
Base unit: HPL, black, Interior: Sheet steel, black		59 kg	5299.-	5049.-
Base unit: HPL, white, Interior: Sheet steel, white		59 kg	5299.-	5049.-
Shell: sheet steel, powder-coated sky blue 5x shelves, height adjustable 4x drawers H15 Fixed position: second and third shelf from the bottom Minimum room height: 234 cm	→ 58 cm ↗ 55 cm ↑ 228 cm			
Base unit: HPL, black, Interior: Sheet steel, black		59 kg	5299.-	5049.-
Base unit: HPL, white, Interior: Sheet steel, white		59 kg	5299.-	5049.-
Shell: sheet steel, powder-coated light grey 5x shelves, height adjustable 4x drawers H15 Fixed position: second and third shelf from the bottom Minimum room height: 234 cm	→ 58 cm ↗ 55 cm ↑ 228 cm			
Base unit: HPL, black, Interior: Sheet steel, black		59 kg	5299.-	5049.-
Base unit: HPL, white, Interior: Sheet steel, white		59 kg	5299.-	5049.-

Preise: UVP exkl. MwSt.
Prix: prix de vente
conseillés hors TVA
Prices: RRP ex. VAT

Bestell-Nr. N° de commande Reference no.	Ausführung, Farbe & Material	Finition, matériau & couleur
 	Mantel: Stahlblech pulverbeschichtet gold Innenausstattung: 5 x Tablar höhenverstellbar 4 x Schubladen H15 Fix montiert im 2. und 3. Fach von unten Mindestraumhöhe: 234 cm	Enveloppe cylindrique: tôle d'acier revêtue par poudre gold 5 étagères réglables en hauteur 4 tiroirs H15 Montage fixe dans les 2e et 3e compartiments en partant du bas Hauteur minimale de la pièce: 234 cm
13-005-218-041	Korpus: HPL schwarz, Innen: Stahlblech schwarz	Corps intérieur: HPL noir, intérieur: tôle d'acier noire
13-005-299-041	Korpus: HPL weiss, Innen: Stahlblech weiss	Corps intérieur: HPL blanc, intérieur: tôle d'acier blanche
 	Mantel: Stahlblech pulverbeschichtet Sonderfarbe RAL/NCS Innenausstattung: 5 x Tablar höhenverstellbar 4 x Schublade H15 Fix montiert im 2. und 3. Fach von unten Mindestraumhöhe: 234 cm	Enveloppe cylindrique: tôle d'acier revêtue par poudre couleur spéciale RAL/NCS 5 étagères réglables en hauteur 4 tiroirs H15 Montage fixe dans les 2e et 3e compartiments en partant du bas Hauteur minimale de la pièce: 234 cm
13-005-218-500	Korpus: HPL schwarz, Innen: Stahlblech schwarz	Corps intérieur: HPL noir, intérieur: tôle d'acier noire
13-005-299-500	Korpus: HPL weiss, Innen: Stahlblech weiss	Corps intérieur: HPL blanc, intérieur: tôle d'acier blanche

Finish, material & colour	Verpackungsmasse Dimensions de l'emballage Package dimensions	Gewicht Poids Weight	CHF	EUR
Shell: sheet steel, powder-coated gold 5x shelves, height adjustable 4x drawers H15 Fixed position: second and third shelf from the bottom Minimum room height: 234 cm	→ 58 cm ↗ 55 cm ↑ 228 cm			
Base unit: HPL, black, Interior: Sheet steel, black		59 kg	5299.-	5049.-
Base unit: HPL, white, Interior: Sheet steel, white		59 kg	5299.-	5049.-
Shell: sheet steel, powder-coated custom RAL/NCS colour 5x shelves, height adjustable 4x drawers H15 Fixed position: second and third shelf from the bottom Minimum room height: 234 cm	→ 58 cm ↗ 55 cm ↑ 228 cm			
Base unit: HPL, black, Interior: Sheet steel, black		59 kg	6099.-	5809.-
Base unit: HPL, white, Interior: Sheet steel, white		59 kg	6099.-	5809.-

Preise: UVP exkl. MwSt.
Prix: prix de vente
conseillés hors TVA
Prices: RRP ex. VAT

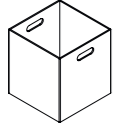
Bestell-Nr. N° de commande Reference no.	Zubehör	Accessoires
	Softbox hellgrau Grösse: 30 x 30 cm h= 30 cm	Softbox gris clair Dimensions: 30 x 30 cm h= 30 cm

13-443

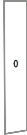
	Kabeldurchführung, Kunststoff schwarz Durchmesser: 7 cm, Innendurchmesser: 5.5 cm Positionierung: 1 x Durchführung Rückwand (im 3. Fach von oben), 1 x Kabelkanal Rückwand, 1 x Durchführung Sockel	Passage de câbles, couleur: plastique noir diamètre: 7 cm, diamètre intérieur: 5.5 cm Positionnement: 1 traversée du panneau arrière, dans le 3e compartiment en partant du haut, 1 passage de câbles panneau arrière 1 passage pour socle
--	---	---

13-012-062

	Kabeldurchführung, Kunststoff weiss Durchmesser: 7 cm, Innendurchmesser: 5.5 cm Positionierung: 1 x Durchführung Rückwand (im 3. Fach von oben), 1 x Kabelkanal Rückwand, 1 x Durchführung Sockel	Passage de câbles, couleur: plastique blanc diamètre: 7 cm, diamètre intérieur: 5.5 cm Positionnement: 1 traversée du panneau arrière, dans le 3e compartiment en partant du haut, 1 passage de câbles panneau arrière 1 passage pour socle
---	---	--



13-012-061

Accessories	Verpackungsmasse Dimensions de l'emballage Package dimensions	Gewicht Poids Weight	CHF	EUR
Softbox, light grey Dimensions: 30 x 30 cm h= 30 cm	→ 40 cm ↗ 40 cm ↑ 6 cm	2 kg	69.-	69.-

Cable grommet, Colour: plastic, black Diameter: 7 cm Inner diameter: 5.5 cm Positioning: 1x grommet on back wall (third shelf from the top) 1x cable grommet, back wall 1x grommet in base			249.-	239.-
--	--	--	-------	-------

Cable grommet, Colour: plastic, white Diameter: 7 cm Inner diameter: 5.5 cm Positioning: 1x grommet on back wall (third shelf from the top) 1x cable grommet, back wall 1x grommet in base			249.-	239.-
--	--	--	-------	-------

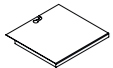
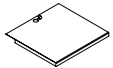
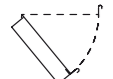
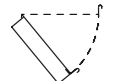
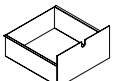
Preise: UVP exkl. MwSt.
Prix: prix de vente
conseillés hors TVA
Prices: RRP ex. VAT

Bestell-Nr. N° de commande Reference no.	Ersatzteile	Pièces de rechange
	Ersatztablar Grösse: 31 x 30.6 cm h= 1.3 cm Farbe: Stahlblech jetblack	Étagère de rechange Dimensions: 31 x 30.6 cm h= 1.3 cm Couleur: tôle d'acier jetblack
13-410-451		
	Ersatztablar Grösse: 31 x 30.6 cm h= 1.3 cm Farbe: Stahlblech weiss	Étagère de rechange Dimensions: 31 x 30.6 cm h= 1.3 cm Couleur: tôle d'acier blanche
13-410-453		
	Ersatzschrägfach (inkl. Tablar) Grösse: 31 x 30.6 cm h= 35 cm Farbe: Stahlblech jetblack	Présentoir incliné de rechange (étagère comprise) Dimensions: 31 x 30.6 cm h= 35 cm Couleur: tôle d'acier jetblack
13-011-451		
	Ersatzschrägfach (inkl. Tablar) Grösse: 31 x 30.6 cm h= 35 cm Farbe: Stahlblech weiss	Présentoir incliné de rechange (étagère comprise) Dimensions: 31 x 30.6 cm h= 35 cm Couleur: tôle d'acier blanche
13-011-453		
	Ersatzschublade H15 Grösse: 31 x 30.5 cm h= 16.2 cm Farbe: Stahlblech jetblack	Tiroir de rechange H15 Dimensions: 31 x 30.5 cm h= 16.2 cm Couleur: tôle d'acier jetblack
13-421-451		
	Ersatzschublade H15 Grösse: 31 x 30.5 cm h= 16.2 cm Farbe: Stahlblech weiss	Tiroir de rechange H15 Dimensions: 31 x 30.5 cm h= 16.2 cm Couleur: tôle d'acier blanche
13-421-453		

Spare parts	Verpackungsmasse Dimensions de l'emballage Package dimensions	Gewicht Poids Weight	CHF	EUR
Replacement shelf Dimensions: 31 x 30.6 cm h= 1.3 cm Colour: Sheet steel, jetblack	→ 35 cm ↗ 35 cm ↑ 3 cm	1.5 kg	79.-	79.-
Replacement shelf Dimensions: 31 x 30.6 cm h= 1.3 cm Colour: Sheet steel, white	→ 35 cm ↗ 35 cm ↑ 3 cm	1.5 kg	79.-	79.-
Replacement slanted display surfaces (incl. shelves) Dimensions: 31 x 30.6 cm h= 35 cm Colour: Sheet steel, jetblack	→ 40 cm ↗ 35 cm ↑ 15 cm	3 kg	189.-	189.-
Replacement slanted display surfaces (incl. shelves) Dimensions: 31 x 30.6 cm h= 35 cm Colour: Sheet steel, white	→ 40 cm ↗ 35 cm ↑ 15 cm	3 kg	189.-	189.-
Replacement drawer H15 Dimensions: 31 x 30.5 cm h= 16.2 cm Colour: Sheet steel, jetblack	→ 35 cm ↗ 35 cm ↑ 25 cm	3 kg	399.-	389.-
Replacement drawer H15 Dimensions: 31 x 30.5 cm h= 16.2 cm Colour: Sheet steel, white	→ 35 cm ↗ 35 cm ↑ 25 cm	3 kg	399.-	389.-

Preise: UVP exkl. MwSt.
Prix: prix de vente
conseillés hors TVA
Prices: RRP ex. VAT





Pillar box small tray

Hommage to Hans Eichenberger

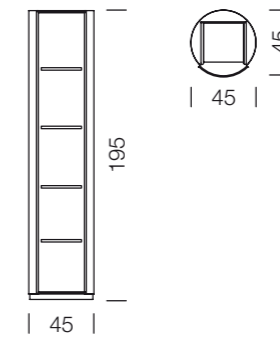



Masse in cm
Dimensions en cm
Dimensions in cm







Bestell-Nr. N° de commande Reference no.	Ausführung, Farbe & Material	Finition, matériau & couleur
 	Mantel: Stahlblech pulverbeschichtet jetblack 4 x Tablar höhenverstellbar Mindestraumhöhe: 220 cm	Enveloppe cylindrique: tôle d'acier revêtue par poudre jetblack 4 étagères réglables en hauteur Hauteur minimale de la pièce: 220 cm
80-002-218-451	Korpus: HPL schwarz, Innen: Stahlblech schwarz	Corps intérieur: HPL noir, intérieur: tôle d'acier noire
80-002-299-451	Korpus: HPL weiss, Innen: Stahlblech weiss	Corps intérieur: HPL blanc, intérieur: tôle d'acier blanche
 	Mantel: Stahlblech pulverbeschichtet traffic white 4 x Tablar höhenverstellbar Mindestraumhöhe: 220 cm	Enveloppe cylindrique: tôle d'acier revêtue par poudre traffic white 4 étagères réglables en hauteur Hauteur minimale de la pièce: 220 cm
80-002-218-453	Korpus: HPL schwarz, Innen: Stahlblech schwarz	Corps intérieur: HPL noir, intérieur: tôle d'acier noire
80-002-299-453	Korpus: HPL weiss, Innen: Stahlblech weiss	Corps intérieur: HPL blanc, intérieur: tôle d'acier blanche

Finish, material & colour	Verpackungsmasse Dimensions de l'emballage Package dimensions	Gewicht Poids Weight	CHF	EUR
Shell: sheet steel, powder-coated jetblack 4x shelves, height adjustable Minimum room height: 220 cm	→ 55 cm ↗ 55 cm ↑ 210 cm			
Base unit: HPL, black, Interior: Sheet steel, black		55 kg	2699.-	2579.-
Base unit: HPL, white, Interior: Sheet steel, white		55 kg	2699.-	2579.-
Shell: sheet steel, powder-coated traffic white 4x shelves, height adjustable Minimum room height: 220 cm	→ 55 cm ↗ 55 cm ↑ 210 cm			
Base unit: HPL, black, Interior: Sheet steel, black		55 kg	2699.-	2579.-
Base unit: HPL, white, Interior: Sheet steel, white		55 kg	2699.-	2579.-

Preise: UVP exkl. MwSt.
Prix: prix de vente
conseillés hors TVA
Prices: RRP ex. VAT







Bestell-Nr. N° de commande Reference no.	Ausführung, Farbe & Material	Finition, matériau & couleur
 	Mantel: Stahlblech pulverbeschichtet stonegrey 4 x Tablar höhenverstellbar Mindestraumhöhe: 220 cm	Enveloppe cylindrique: tôle d'acier revêtue par poudre stonegrey 4 étagères réglables en hauteur Hauteur minimale de la pièce: 220 cm
80-002-218-454	Korpus: HPL schwarz, Innen: Stahlblech schwarz	Corps intérieur: HPL noir, intérieur: tôle d'acier noire
80-002-299-454	Korpus: HPL weiss, Innen: Stahlblech weiss	Corps intérieur: HPL blanc, intérieur: tôle d'acier blanche

 	Mantel: Stahlblech pulverbeschichtet morning tea 4 x Tablar höhenverstellbar Mindestraumhöhe: 220 cm	Enveloppe cylindrique: tôle d'acier revêtue par poudre morning tea 4 étagères réglables en hauteur Hauteur minimale de la pièce: 220 cm
80-002-218-459	Korpus: HPL schwarz, Innen: Stahlblech schwarz	Corps intérieur: HPL noir, intérieur: tôle d'acier noire
80-002-299-459	Korpus: HPL weiss, Innen: Stahlblech weiss	Corps intérieur: HPL blanc, intérieur: tôle d'acier blanche

 	Mantel: Stahlblech pulverbeschichtet saffron 4 x Tablar höhenverstellbar Mindestraumhöhe: 220 cm	Enveloppe cylindrique: tôle d'acier revêtue par poudre saffron 4 étagères réglables en hauteur Hauteur minimale de la pièce: 220 cm
80-002-218-462	Korpus: HPL schwarz, Innen: Stahlblech schwarz	Corps intérieur: HPL noir, intérieur: tôle d'acier noire
80-002-299-462	Korpus: HPL weiss, Innen: Stahlblech weiss	Corps intérieur: HPL blanc, intérieur: tôle d'acier blanche



Finish, material & colour	Verpackungsmasse Dimensions de l'emballage Package dimensions	Gewicht Poids Weight	CHF	EUR
Shell: sheet steel, powder-coated stonegrey 4x shelves, height adjustable Minimum room height: 220 cm	→ 55 cm ↗ 55 cm ↑ 210 cm			
Base unit: HPL, black, Interior: Sheet steel, black		55 kg	2699.-	2579.-
Base unit: HPL, white, Interior: Sheet steel, white		55 kg	2699.-	2579.-
Shell: sheet steel, powder-coated morning tea 4x shelves, height adjustable Minimum room height: 220 cm	→ 55 cm ↗ 55 cm ↑ 210 cm			
Base unit: HPL, black, Interior: Sheet steel, black		55 kg	2699.-	2579.-
Base unit: HPL, white, Interior: Sheet steel, white		55 kg	2699.-	2579.-
Shell: sheet steel, powder-coated saffron 4x shelves, height adjustable Minimum room height: 220 cm	→ 55 cm ↗ 55 cm ↑ 210 cm			
Base unit: HPL, black, Interior: Sheet steel, black		55 kg	2699.-	2579.-
Base unit: HPL, white, Interior: Sheet steel, white		55 kg	2699.-	2579.-



Preise: UVP exkl. MwSt.
Prix: prix de vente
conseillés hors TVA
Prices: RRP ex. VAT

Bestell-Nr. N° de commande Reference no.	Ausführung, Farbe & Material	Finition, matériau & couleur
 	Mantel: Stahlblech pulverbeschichtet olive 4 x Tablar höhenverstellbar Mindestraumhöhe: 220 cm	Enveloppe cylindrique: tôle d'acier revêtue par poudre olive 4 étagères réglables en hauteur Hauteur minimale de la pièce: 220 cm
80-002-218-466	Korpus: HPL schwarz, Innen: Stahlblech schwarz	Corps intérieur: HPL noir, intérieur: tôle d'acier noire
80-002-299-466	Korpus: HPL weiss, Innen: Stahlblech weiss	Corps intérieur: HPL blanc, intérieur: tôle d'acier blanche
 	Mantel: Stahlblech pulverbeschichtet sky blue 4 x Tablar höhenverstellbar Mindestraumhöhe: 220 cm	Enveloppe cylindrique: tôle d'acier revêtue par poudre sky blue 4 étagères réglables en hauteur Hauteur minimale de la pièce: 220 cm
80-002-218-467	Korpus: HPL schwarz, Innen: Stahlblech schwarz	Corps intérieur: HPL noir, intérieur: tôle d'acier noire
80-002-299-467	Korpus: HPL weiss, Innen: Stahlblech weiss	Corps intérieur: HPL blanc, intérieur: tôle d'acier blanche
 	Mantel: Stahlblech pulverbeschichtet light grey 4 x Tablar höhenverstellbar Mindestraumhöhe: 220 cm	Enveloppe cylindrique: tôle d'acier revêtue par poudre light grey 4 étagères réglables en hauteur Hauteur minimale de la pièce: 220 cm
80-002-218-468	Korpus: HPL schwarz, Innen: Stahlblech schwarz	Corps intérieur: HPL noir, intérieur: tôle d'acier noire
80-002-299-468	Korpus: HPL weiss, Innen: Stahlblech weiss	Corps intérieur: HPL blanc, intérieur: tôle d'acier blanche

Finish, material & colour	Verpackungsmasse Dimensions de l'emballage Package dimensions	Gewicht Poids Weight	CHF	EUR
Shell: sheet steel, powder-coated olive 4x shelves, height adjustable Minimum room height: 220 cm	→ 55 cm ↗ 55 cm ↑ 210 cm			
Base unit: HPL, black, Interior: Sheet steel, black		55 kg	2699.-	2579.-
Base unit: HPL, white, Interior: Sheet steel, white		55 kg	2699.-	2579.-
Shell: sheet steel, powder-coated sky blue 4x shelves, height adjustable Minimum room height: 220 cm	→ 55 cm ↗ 55 cm ↑ 210 cm			
Base unit: HPL, black, Interior: Sheet steel, black		55 kg	2699.-	2579.-
Base unit: HPL, white, Interior: Sheet steel, white		55 kg	2699.-	2579.-
Shell: sheet steel, powder-coated light grey 4x shelves, height adjustable Minimum room height: 220 cm	→ 55 cm ↗ 55 cm ↑ 210 cm			
Base unit: HPL, black, Interior: Sheet steel, black		55 kg	2699.-	2579.-
Base unit: HPL, white, Interior: Sheet steel, white		55 kg	2699.-	2579.-

Preise: UVP exkl. MwSt.
Prix: prix de vente
conseillés hors TVA
Prices: RRP ex. VAT

Bestell-Nr. N° de commande Reference no.	Ausführung, Farbe & Material	Finition, matériau & couleur
 	Mantel: Stahlblech pulverbeschichtet gold 4 x Tablar höhenverstellbar Mindestraumhöhe: 220 cm	Enveloppe cylindrique: tôle d'acier revêtue par poudre gold 4 étagères réglables en hauteur Hauteur minimale de la pièce: 220 cm
80-002-218-041	Korpus: HPL schwarz, Innen: Stahlblech schwarz	Corps intérieur: HPL noir, intérieur: tôle d'acier noire
80-002-299-041	Korpus: HPL weiss, Innen: Stahlblech weiss	Corps intérieur: HPL blanc, intérieur: tôle d'acier blanche

 	Mantel: Stahlblech pulverbeschichtet Sonderfarbe RAL/NCS 4 x Tablar höhenverstellbar Mindestraumhöhe: 220 cm	Enveloppe cylindrique: tôle d'acier revêtue par poudre couleur spéciale RAL/NCS 4 étagères réglables en hauteur Hauteur minimale de la pièce: 220 cm
80-002-218-500	Korpus: HPL schwarz, Innen: Stahlblech schwarz	Corps intérieur: HPL noir, intérieur: tôle d'acier noire
80-002-229-500	Korpus: HPL weiss, Innen: Stahlblech weiss	Corps intérieur: HPL blanc, intérieur: tôle d'acier blanche

Finish, material & colour	Verpackungsmasse Dimensions de l'emballage Package dimensions	Gewicht Poids Weight	CHF	EUR
Shell: sheet steel, powder-coated gold 4x shelves, height adjustable Minimum room height: 220 cm	→ 55 cm ↗ 55 cm ↑ 210 cm			
Base unit: HPL, black, Interior: Sheet steel, black		55 kg	2699.-	2579.-
Base unit: HPL, white, Interior: Sheet steel, white		55 kg	2699.-	2579.-
Shell: sheet steel, powder-coated custom RAL/NCS colour 4x shelves, height adjustable Minimum room height: 220 cm	→ 55 cm ↗ 55 cm ↑ 210 cm			
Base unit: HPL, black, Interior: Sheet steel, black		55 kg	2699.-	2579.-
Base unit: HPL, white, Interior: Sheet steel, white		55 kg	2699.-	2579.-



Pillar box small display

Hommage to Hans Eichenberger

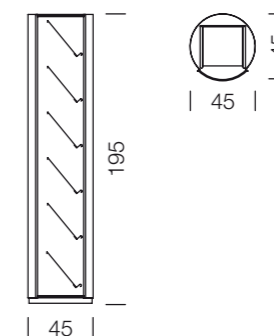

Masse in cm
Dimensions en cm
Dimensions in cm





Bestell-Nr. N° de commande Reference no.	Ausführung, Farbe & Material	Finition, matériau & couleur
	Mantel: Stahlblech pulverbeschichtet jetblack 4 x Schrägfächer (inkl. Tablare) Mindestraumhöhe: 220 cm	Enveloppe cylindrique: tôle d'acier revêtue par poudre jetblack 4 présentoirs inclinés (étagères comprises) Hauteur minimale de la pièce: 220 cm
80-003-218-451	Korpus: HPL schwarz, Innen: Stahlblech schwarz	Corps intérieur: HPL noir, intérieur: tôle d'acier noire
80-003-299-451	Korpus: HPL weiss, Innen: Stahlblech weiss	Corps intérieur: HPL blanc, intérieur: tôle d'acier blanche
	Mantel: Stahlblech pulverbeschichtet traffic white 4 x Schrägfächer (inkl. Tablare) Mindestraumhöhe: 220 cm	Enveloppe cylindrique: tôle d'acier revêtue par poudre traffic white 4 présentoirs inclinés (étagères comprises) Hauteur minimale de la pièce: 220 cm
80-003-218-453	Korpus: HPL schwarz, Innen: Stahlblech schwarz	Corps intérieur: HPL noir, intérieur: tôle d'acier noire
80-003-299-453	Korpus: HPL weiss, Innen: Stahlblech weiss	Corps intérieur: HPL blanc, intérieur: tôle d'acier blanche

Finish, material & colour	Verpackungsmasse Dimensions de l'emballage Package dimensions	Gewicht Poids Weight	CHF	EUR
Shell: sheet steel, powder-coated jetblack 4x slanted display surfaces (incl. shelves) Minimum room height: 220 cm	→ 55 cm ↗ 55 cm ↑ 210 cm			
Base unit: HPL, black, Interior: Sheet steel, black		55 kg	2699.-	2579.-
Base unit: HPL, white, Interior: Sheet steel, white		55 kg	2699.-	2579.-
Shell: sheet steel, powder-coated traffic white 4x slanted display surfaces (incl. shelves) Minimum room height: 220 cm	→ 55 cm ↗ 55 cm ↑ 210 cm			
Base unit: HPL, black, Interior: Sheet steel, black		55 kg	2699.-	2579.-
Base unit: HPL, white, Interior: Sheet steel, white		55 kg	2699.-	2579.-

Preise: UVP exkl. MwSt.
Prix: prix de vente
conseillés hors TVA
Prices: RRP ex. VAT

Bestell-Nr. N° de commande Reference no.	Ausführung, Farbe & Material	Finition, matériau & couleur
	Mantel: Stahlblech pulverbeschichtet stonegrey 4 x Schrägfächer (inkl. Tablare) Mindestraumhöhe: 220 cm	Enveloppe cylindrique: tôle d'acier revêtue par poudre stonegrey 4 présentoirs inclinés (étagères comprises) Hauteur minimale de la pièce: 220 cm
80-003-218-454	Korpus: HPL schwarz, Innen: Stahlblech schwarz	Corps intérieur: HPL noir, intérieur: tôle d'acier noire
80-003-299-454	Korpus: HPL weiss, Innen: Stahlblech weiss	Corps intérieur: HPL blanc, intérieur: tôle d'acier blanche

	Mantel: Stahlblech pulverbeschichtet morning tea 4 x Schrägfächer (inkl. Tablare) Mindestraumhöhe: 220 cm	Enveloppe cylindrique: tôle d'acier revêtue par poudre morning tea 4 présentoirs inclinés (étagères comprises) Hauteur minimale de la pièce: 220 cm
80-003-218-459	Korpus: HPL schwarz, Innen: Stahlblech schwarz	Corps intérieur: HPL noir, intérieur: tôle d'acier noire
80-003-299-459	Korpus: HPL weiss, Innen: Stahlblech weiss	Corps intérieur: HPL blanc, intérieur: tôle d'acier blanche

	Mantel: Stahlblech pulverbeschichtet saffron 4 x Schrägfächer (inkl. Tablare) Mindestraumhöhe: 220 cm	Enveloppe cylindrique: tôle d'acier revêtue par poudre saffron 4 présentoirs inclinés (étagères comprises) Hauteur minimale de la pièce: 220 cm
80-003-218-462	Korpus: HPL schwarz, Innen: Stahlblech schwarz	Corps intérieur: HPL noir, intérieur: tôle d'acier noire
80-003-299-462	Korpus: HPL weiss, Innen: Stahlblech weiss	Corps intérieur: HPL blanc, intérieur: tôle d'acier blanche

Finish, material & colour	Verpackungsmasse Dimensions de l'emballage Package dimensions	Gewicht Poids Weight	CHF	EUR
Shell: sheet steel, powder-coated stonegrey 4x slanted display surfaces (incl. shelves) Minimum room height: 220 cm	→ 55 cm ↗ 55 cm ↑ 210 cm			
Base unit: HPL, black, Interior: Sheet steel, black		55 kg	2699.-	2579.-
Base unit: HPL, white, Interior: Sheet steel, white		55 kg	2699.-	2579.-
Shell: sheet steel, powder-coated morning tea 4x slanted display surfaces (incl. shelves) Minimum room height: 220 cm	→ 55 cm ↗ 55 cm ↑ 210 cm			
Base unit: HPL, black, Interior: Sheet steel, black		55 kg	2699.-	2579.-
Base unit: HPL, white, Interior: Sheet steel, white		55 kg	2699.-	2579.-
Shell: sheet steel, powder-coated saffron 4x slanted display surfaces (incl. shelves) Minimum room height: 220 cm	→ 55 cm ↗ 55 cm ↑ 210 cm			
Base unit: HPL, black, Interior: Sheet steel, black		55 kg	2699.-	2579.-
Base unit: HPL, white, Interior: Sheet steel, white		55 kg	2699.-	2579.-

Preise: UVP exkl. MwSt.
Prix: prix de vente
conseillés hors TVA
Prices: RRP ex. VAT



Bestell-Nr. N° de commande Reference no.	Ausführung, Farbe & Material	Finition, matériau & couleur
	Mantel: Stahlblech pulverbeschichtet olive 4 x Schrägfächer (inkl. Tablare) Mindestraumhöhe: 220 cm	Enveloppe cylindrique: tôle d'acier revêtue par poudre olive 4 présentoirs inclinés (étagères comprises) Hauteur minimale de la pièce: 220 cm
80-003-218-466	Korpus: HPL schwarz, Innen: Stahlblech schwarz	Corps intérieur: HPL noir, intérieur: tôle d'acier noire
80-003-299-466	Korpus: HPL weiss, Innen: Stahlblech weiss	Corps intérieur: HPL blanc, intérieur: tôle d'acier blanche



	Mantel: Stahlblech pulverbeschichtet sky blue 4 x Schrägfächer (inkl. Tablare) Mindestraumhöhe: 220 cm	Enveloppe cylindrique: tôle d'acier revêtue par poudre sky blue 4 présentoirs inclinés (étagères comprises) Hauteur minimale de la pièce: 220 cm
80-003-218-467	Korpus: HPL schwarz, Innen: Stahlblech schwarz	Corps intérieur: HPL noir, intérieur: tôle d'acier noire
80-003-299-467	Korpus: HPL weiss, Innen: Stahlblech weiss	Corps intérieur: HPL blanc, intérieur: tôle d'acier blanche

	Mantel: Stahlblech pulverbeschichtet light grey 4 x Schrägfächer (inkl. Tablare) Mindestraumhöhe: 220 cm	Enveloppe cylindrique: tôle d'acier revêtue par poudre light grey 4 présentoirs inclinés (étagères comprises) Hauteur minimale de la pièce: 220 cm
80-003-218-468	Korpus: HPL schwarz, Innen: Stahlblech schwarz	Corps intérieur: HPL noir, intérieur: tôle d'acier noire
80-003-299-468	Korpus: HPL weiss, Innen: Stahlblech weiss	Corps intérieur: HPL blanc, intérieur: tôle d'acier blanche

Finish, material & colour	Verpackungsmasse Dimensions de l'emballage Package dimensions	Gewicht Poids Weight	CHF	EUR
Shell: sheet steel, powder-coated olive 4x slanted display surfaces (incl. shelves) Minimum room height: 220 cm	→ 55 cm ↗ 55 cm ↑ 210 cm			
Base unit: HPL, black, Interior: Sheet steel, black		55 kg	2699.-	2579.-
Base unit: HPL, white, Interior: Sheet steel, white		55 kg	2699.-	2579.-
Shell: sheet steel, powder-coated sky blue 4x slanted display surfaces (incl. shelves) Minimum room height: 220 cm	→ 55 cm ↗ 55 cm ↑ 210 cm			
Base unit: HPL, black, Interior: Sheet steel, black		55 kg	2699.-	2579.-
Base unit: HPL, white, Interior: Sheet steel, white		55 kg	2699.-	2579.-
Shell: sheet steel, powder-coated light grey 4x slanted display surfaces (incl. shelves) Minimum room height: 220 cm	→ 55 cm ↗ 55 cm ↑ 210 cm			
Base unit: HPL, black, Interior: Sheet steel, black		55 kg	2699.-	2579.-
Base unit: HPL, white, Interior: Sheet steel, white		55 kg	2699.-	2579.-

Preise: UVP exkl. MwSt.
Prix: prix de vente
conseillés hors TVA
Prices: RRP ex. VAT

Bestell-Nr. N° de commande Reference no.	Ausführung, Farbe & Material	Finition, matériau & couleur
 	Mantel: Stahlblech pulverbeschichtet gold 4 x Schrägfächer (inkl. Tablare) Mindestraumhöhe: 220 cm	Enveloppe cylindrique: tôle d'acier revêtue par poudre gold 4 présentoirs inclinés (étagères comprises) Hauteur minimale de la pièce: 220 cm
80-003-218-041	Korpus: HPL schwarz, Innen: Stahlblech schwarz	Corps intérieur: HPL noir, intérieur: tôle d'acier noire
80-003-299-041	Korpus: HPL weiss, Innen: Stahlblech weiss	Corps intérieur: HPL blanc, intérieur: tôle d'acier blanche

 	Mantel: Stahlblech pulverbeschichtet Sonderfarbe RAL/NCS 4 x Schrägfächer (inkl. Tablare) Mindestraumhöhe: 220 cm	Enveloppe cylindrique: tôle d'acier revêtue par poudre couleur spéciale RAL/NCS 4 présentoirs inclinés (étagères comprises) Hauteur minimale de la pièce: 220 cm
80-003-218-500	Korpus: HPL schwarz, Innen: Stahlblech schwarz	Corps intérieur: HPL noir, intérieur: tôle d'acier noire
80-003-229-500	Korpus: HPL weiss, Innen: Stahlblech weiss	Corps intérieur: HPL blanc, intérieur: tôle d'acier blanche

Finish, material & colour	Verpackungsmasse Dimensions de l'emballage Package dimensions	Gewicht Poids Weight	CHF	EUR
Shell: sheet steel, powder-coated gold 4x slanted display surfaces (incl. shelves) Minimum room height: 220 cm	→ 55 cm ↗ 55 cm ↑ 210 cm			
Base unit: HPL, black, Interior: Sheet steel, black		55 kg	2699.-	2579.-
Base unit: HPL, white, Interior: Sheet steel, white		55 kg	2699.-	2579.-
Shell: sheet steel, powder-coated custom RAL/NCS colour 4x slanted display surfaces (incl. shelves) Minimum room height: 220 cm	→ 55 cm ↗ 55 cm ↑ 210 cm			
Base unit: HPL, black, Interior: Sheet steel, black		55 kg	2699.-	2579.-
Base unit: HPL, white, Interior: Sheet steel, white		55 kg	2699.-	2579.-

Bestell-Nr. N° de commande Reference no.	Ersatzteile	Pièces de rechange
	Ersatztablar Grösse: 25 x 27 cm h= 1.3 cm Farbe: Stahlblech jetblack	Étagère de rechange Dimensions: 25 x 27 cm h= 1.3 cm Couleur: tôle d'acier jetblack
80-410-451		
	Ersatztablar Grösse: 25 x 27 cm h= 1.3 cm Farbe: Stahlblech weiss	Étagère de rechange Dimensions: 25 x 27 cm h= 1.3 cm Couleur: tôle d'acier blanche
80-410-453		
	Ersatzschrägfach Grösse: 25 x 27 cm h= 1.3 cm Farbe: Stahlblech jetblack	Présentoir incliné de rechange Dimensions: 25 x 27 cm h= 1.3 cm Couleur: tôle d'acier jetblack
80-011-451		
	Ersatzschrägfach Grösse: 25 x 27 cm h= 1.3 cm Farbe: Stahlblech weiss	Présentoir incliné de rechange Dimensions: 25 x 27 cm h= 1.3 cm Couleur: tôle d'acier blanche
80-011-453		

Spare parts	Verpackungsmasse Dimensions de l'emballage Package dimensions	Gewicht Poids Weight	CHF	EUR
Replacement shelf Dimensions: 25 x 27 cm h= 1.3 cm Colour: Sheet steel, jetblack	→ 35 cm ↗ 35 cm ↑ 3 cm			
		1.5 kg	79.-	79.-
Replacement shelf Dimensions: 25 x 27 cm h= 1.3 cm Colour: Sheet steel, white	→ 35 cm ↗ 35 cm ↑ 3 cm			
		1.5 kg	79.-	79.-
Replacement slanted display surfaces Dimensions: 25 x 27 cm h= 1.3 cm Colour: Sheet steel, jetblack	→ 35 cm ↗ 35 cm ↑ 5 cm			
		2 kg	169.-	169.-
Replacement slanted display surfaces Dimensions: 25 x 27 cm h= 1.3 cm Colour: Sheet steel, white	→ 35 cm ↗ 35 cm ↑ 5 cm			
		2 kg	169.-	169.-

Design:
Christophe Marchand
2021



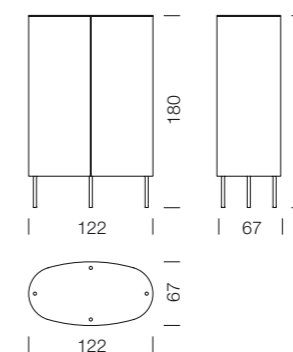

Masse in cm
Dimensions en cm
Dimensions in cm



Bestell-Nr. N° de commande Reference no.	Ausführung, Farbe & Material	Finition, matériau & couleur
	<p>Korpus: Holzwerkstoff schwarz Boden: Holzwerkstoff schwarz mit Kabeldurchführung (hinten mittig) Kunststoff Schwarz, d= 7 / 5.5 cm Rückwand und Seiten innen: Holzwerkstoff schwarz lackiert Fuss: Stahl pulverbeschichtet jetblack, Fushöhe: 30 cm Innenausstattung: 1 x Fixtablar mit Mittelwand (oben) 1 x Kleiderstange 2 x Haken für Kleiderstange</p>	<p>Corps: bois composite noir Base: bois composite noir avec passage de câbles (centré à l'arrière) en plastique noir, d= 7 / 5.5 cm Intérieur panneau arrière et côtés: bois composite laqué noir, pied: acier revêtu par poudre jetblack, hauteur du pied: 30 cm Aménagement intérieur: 1 étagère fixe avec cloison centrale (en haut) 1 tringle à vêtements 2 crochets pour tringle à vêtements</p>
79-002-321-331-014-451	Rollfront: Aluminium schwarz eloxiert	Porte coulissante: aluminium anodisé noir
	<p>Korpus: Holzwerkstoff schwarz Boden: Holzwerkstoff schwarz mit Kabeldurchführung (hinten mittig) Kunststoff Schwarz, d= 7 / 5.5 cm Rückwand und Seiten innen: Holzwerkstoff schwarz lackiert Fuss: Stahl pulverbeschichtet jetblack, Fushöhe: 30 cm Innenausstattung: 1 x Fixtablar mit Mittelwand (oben) 1 x Kleiderstange 2 x Haken für Kleiderstange</p>	<p>Corps: bois composite noir Base: bois composite noir avec passage de câbles (centré à l'arrière) en plastique noir, d= 7 / 5.5 cm Intérieur panneau arrière et côtés: bois composite laqué noir, pied: acier revêtu par poudre jetblack, hauteur du pied: 30 cm Aménagement intérieur: 1 étagère fixe avec cloison centrale (en haut) 1 tringle à vêtements 2 crochets pour tringle à vêtements</p>
79-002-321-331-013-451	Rollfront: Aluminium natur eloxiert	Porte coulissante: aluminium anodisé naturel

Finish, material & colour	Verpackungsmasse Dimensions de l'emballage Package dimensions	Gewicht Poids Weight	CHF	EUR
<p>Base unit: engineered wood, black Base: engineered wood, black, with black plastic cable grommet (centre back) d= 7 / 5.5 cm Back wall / sides: engineered wood, black lacquered Feet: steel, powder-coated jetblack, Foot height: 30 cm Interior: 1x fixed shelf with centre wall (top) 1x clothes rail 2x hooks for clothes rail</p>	<p>→ 130 cm ↗ 75 cm ↑ 190 cm</p>	115 kg	4899.-	4669.-
Tambour door: aluminium, black anodized				
<p>Base unit: engineered wood, black Base: engineered wood, black, with black plastic cable grommet (centre back) d= 7 / 5.5 cm Back wall / sides: engineered wood, black lacquered Feet: steel, powder-coated jetblack, Foot height: 30 cm Interior: 1x fixed shelf with centre wall (top) 1x clothes rail 2x hooks for clothes rail</p>	<p>→ 130 cm ↗ 75 cm ↑ 190 cm</p>			
Tambour door: aluminium, natural anodized				

Preise: UVP exkl. MwSt.
Prix: prix de vente
conseillés hors TVA
Prices: RRP ex. VAT

Bestell-Nr. N° de commande Reference no.	Ausführung, Farbe & Material	Finition, matériau & couleur
	<p>Korpus: Holzwerkstoff schwarz Boden: Holzwerkstoff schwarz mit Kabeldurchführung (hinten mittig) Kunststoff Schwarz, d= 7 / 5.5 cm Rückwand und Seiten innen: Holzwerkstoff schwarz lackiert Fuss: Stahl pulverbeschichtet jetblack, Fusshöhe: 30 cm Innenausstattung: 1 x Fixtablar mit Mittelwand (oben) 1 x Kleiderstange 2 x Haken für Kleiderstange</p>	<p>Corps: bois composite noir Base: bois composite noir avec passage de câbles (centré à l'arrière) en plastique noir, d= 7 / 5.5 cm Intérieur panneau arrière et côtés: bois composite laqué noir, pied: acier revêtu par poudre jetblack, hauteur du pied: 30 cm Aménagement intérieur: 1 étagère fixe avec cloison centrale (en haut) 1 tringle à vêtements 2 crochets pour tringle à vêtements</p>
79-002-321-331-015-451	Rollfront: Aluminium champagner eloxiert	Porte coulissante: aluminium anodisé champagne
	<p>Korpus: Holzwerkstoff schwarz Boden: Holzwerkstoff schwarz mit Kabeldurchführung (hinten mittig) Kunststoff Schwarz, d= 7 / 5.5 cm Rückwand und Seiten innen: Holzwerkstoff schwarz lackiert Fuss: Stahl pulverbeschichtet jetblack, Fusshöhe: 30 cm Innenausstattung: 1 x Fixtablar mit Mittelwand (oben) 1 x Kleiderstange 2 x Haken für Kleiderstange</p>	<p>Corps: bois composite noir Base: bois composite noir avec passage de câbles (centré à l'arrière) en plastique noir, d= 7 / 5.5 cm Intérieur panneau arrière et côtés: bois composite laqué noir, pied: acier revêtu par poudre jetblack, hauteur du pied: 30 cm Aménagement intérieur: 1 étagère fixe avec cloison centrale (en haut) 1 tringle à vêtements 2 crochets pour tringle à vêtements</p>
79-002-321-331-400-451	Rollfront: Aluminium in Sonderfarbe lackiert RAL/NCS	Porte coulissante: aluminium couleur spéciale RAL/NCS

Finish, material & colour	Verpackungsmasse Dimensions de l'emballage Package dimensions	Gewicht Poids Weight	CHF	EUR
<p>Base unit: engineered wood, black Base: engineered wood, black, with black plastic cable grommet (centre back) d= 7 / 5.5 cm Back wall / sides: engineered wood, black lacquered Feet: steel, powder-coated jetblack, Foot height: 30 cm Interior: 1x fixed shelf with centre wall (top) 1x clothes rail 2x hooks for clothes rail</p>	<p>→ 130 cm ↗ 75 cm ↑ 190 cm</p>			
Tambour door: aluminium, champagne anodized		115 kg	4899.-	4669.-
<p>Base unit: engineered wood, black Base: engineered wood, black, with black plastic cable grommet (centre back) d= 7 / 5.5 cm Back wall / sides: engineered wood, black lacquered Feet: steel, powder-coated jetblack, Foot height: 30 cm Interior: 1x fixed shelf with centre wall (top) 1x clothes rail 2x hooks for clothes rail</p>	<p>→ 130 cm ↗ 75 cm ↑ 190 cm</p>			
Tambour door: aluminium, custom RAL/NCS colour		115 kg	6149.-	5859.-

Design:
Christophe Marchand
2021



Masse in cm
Dimensions en cm
Dimensions in cm

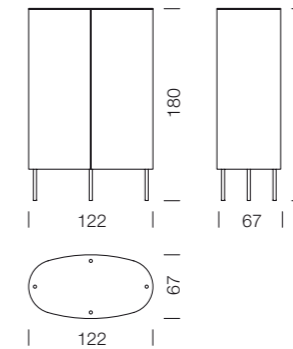

Bestell-Nr. N° de commande Reference no.	Ausführung, Farbe & Material	Finition, matériau & couleur
	<p>Korpus: Holzwerkstoff schwarz Boden: Holzwerkstoff schwarz mit Kabeldurchführung (hinten mittig) Kunststoff Schwarz, d= 7 / 5.5 cm Rückwand und Seiten innen: Holzwerkstoff schwarz lackiert Fuss: Stahl pulverbeschichtet jetblack, Fusshöhe: 30 cm Innenausstattung: 1 x Fixtablar mit Mittelwand (oben) 3 x Tablar höhenverstellbar (Raster: 9.6 cm) mit Kabeldurchlass (gerundete Aussparung hinten mittig/rechts)</p>	<p>Corps: bois composite noir Base: bois composite noir avec passage de câbles (centré à l'arrière) en plastique noir, d= 7 / 5.5 cm Intérieur panneau arrière et côtés: bois composite laqué noir, pied: acier revêtu par poudre jetblack, hauteur du pied: 30 cm Aménagement intérieur: 1 étagère fixe avec cloison centrale (en haut) 3 étagères réglables en hauteur (pas: 9.6 cm) avec passage de câbles (arrondi centré/à droite à l'arrière)</p>
79-003-321-331-014-451	Rollfront: Aluminium schwarz eloxiert	Porte coulissante: aluminium anodisé noir
	<p>Korpus: Holzwerkstoff schwarz Boden: Holzwerkstoff schwarz mit Kabeldurchführung (hinten mittig) Kunststoff Schwarz, d= 7 / 5.5 cm Rückwand und Seiten innen: Holzwerkstoff schwarz lackiert Fuss: Stahl pulverbeschichtet jetblack, Fusshöhe: 30 cm Innenausstattung: 1 x Fixtablar mit Mittelwand (oben) 3 x Tablar höhenverstellbar (Raster: 9.6 cm) mit Kabeldurchlass (gerundete Aussparung hinten mittig/rechts)</p>	<p>Corps: bois composite noir Base: bois composite noir avec passage de câbles (centré à l'arrière) en plastique noir, d= 7 / 5.5 cm Intérieur panneau arrière et côtés: bois composite laqué noir, pied: acier revêtu par poudre jetblack, hauteur du pied: 30 cm Aménagement intérieur: 1 étagère fixe avec cloison centrale (en haut) 3 étagères réglables en hauteur (pas: 9.6 cm) avec passage de câbles (arrondi centré/à droite à l'arrière)</p>
79-003-321-331-013-451	Rollfront: Aluminium natur eloxiert	Porte coulissante: aluminium anodisé naturel

Finish, material & colour	Verpackungsmasse Dimensions de l'emballage Package dimensions	Gewicht Poids Weight	CHF	EUR
<p>Base unit: engineered wood, black Base: engineered wood, black, with black plastic cable grommet (centre back) d= 7 / 5.5 cm Back wall / sides: engineered wood, black lacquered Feet: steel, powder-coated jetblack, Foot height: 30 cm Interior: 1x fixed shelf with centre wall (top) 3x shelves, height adjustable (in 9.6 cm increments) with cable grommet (round opening, back centre/right)</p>	<p>→ 130 cm ↗ 75 cm ↑ 190 cm</p>	120 kg	5249.-	4999.-
Tambour door: aluminium, black anodized				
<p>Base unit: engineered wood, black Base: engineered wood, black, with black plastic cable grommet (centre back) d= 7 / 5.5 cm Back wall / sides: engineered wood, black lacquered Feet: steel, powder-coated jetblack, Foot height: 30 cm Interior: 1x fixed shelf with centre wall (top) 3x shelves, height adjustable (in 9.6 cm increments) with cable grommet (round opening, back centre/right)</p>	<p>→ 130 cm ↗ 75 cm ↑ 190 cm</p>			
Tambour door: aluminium, natural anodized				

Bestell-Nr. N° de commande Reference no.	Ausführung, Farbe & Material	Finition, matériau & couleur
	<p>Korpus: Holzwerkstoff schwarz Boden: Holzwerkstoff schwarz mit Kabeldurchführung (hinten mittig) Kunststoff Schwarz, d= 7 / 5.5 cm Rückwand und Seiten innen: Holzwerkstoff schwarz lackiert Fuss: Stahl pulverbeschichtet jetblack, Fusshöhe: 30 cm Innenausstattung: 1 x Fixtablar mit Mittelwand (oben) 3 x Tablar höhenverstellbar (Raster: 9.6 cm) mit Kabeldurchlass (gerundete Aussparung hinten mittig/rechts)</p>	<p>Corps: bois composite noir Base: bois composite noir avec passage de câbles (centré à l'arrière) en plastique noir, d= 7 / 5.5 cm Intérieur panneau arrière et côtés: bois composite laqué noir, pied: acier revêtu par poudre jetblack, hauteur du pied: 30 cm Aménagement intérieur: 1 étagère fixe avec cloison centrale (en haut) 3 étagères réglables en hauteur (pas: 9.6 cm) avec passage de câbles (arrondi centré/à droite à l'arrière)</p>
79-003-321-331-015-451	Rollfront: Aluminium champagner eloxiert	Porte coulissante: aluminium anodisé champagne
	<p>Korpus: Holzwerkstoff schwarz Boden: Holzwerkstoff schwarz mit Kabeldurchführung (hinten mittig) Kunststoff Schwarz, d= 7 / 5.5 cm Rückwand und Seiten innen: Holzwerkstoff schwarz lackiert Fuss: Stahl pulverbeschichtet jetblack, Fusshöhe: 30 cm Innenausstattung: 1 x Fixtablar mit Mittelwand (oben) 3 x Tablar höhenverstellbar (Raster: 9.6 cm) mit Kabeldurchlass (gerundete Aussparung hinten mittig/rechts)</p>	<p>Corps: bois composite noir Base: bois composite noir avec passage de câbles (centré à l'arrière) en plastique noir, d= 7 / 5.5 cm Intérieur panneau arrière et côtés: bois composite laqué noir, pied: acier revêtu par poudre jetblack, hauteur du pied: 30 cm Aménagement intérieur: 1 étagère fixe avec cloison centrale (en haut) 3 étagères réglables en hauteur (pas: 9.6 cm) avec passage de câbles (arrondi centré/à droite à l'arrière)</p>
79-003-321-331-400-451	Rollfront: Aluminium in Sonderfarbe lackiert RAL/NCS	Porte coulissante: aluminium couleur spéciale RAL/NCS

Finish, material & colour	Verpackungsmasse Dimensions de l'emballage Package dimensions	Gewicht Poids Weight	CHF	EUR
<p>Base unit: engineered wood, black Base: engineered wood, black, with black plastic cable grommet (centre back) d= 7 / 5.5 cm Back wall / sides: engineered wood, black lacquered Feet: steel, powder-coated jetblack, Foot height: 30 cm Interior: 1x fixed shelf with centre wall (top) 3x shelves, height adjustable (in 9.6 cm increments) with cable grommet (round opening, back centre/right)</p>	<p>→ 130 cm ↗ 75 cm ↑ 190 cm</p>			
Tambour door: aluminium, champagne anodized		120 kg	5249.-	4999.-
<p>Base unit: engineered wood, black Base: engineered wood, black, with black plastic cable grommet (centre back) d= 7 / 5.5 cm Back wall / sides: engineered wood, black lacquered Feet: steel, powder-coated jetblack, Foot height: 30 cm Interior: 1x fixed shelf with centre wall (top) 3x shelves, height adjustable (in 9.6 cm increments) with cable grommet (round opening, back centre/right)</p>	<p>→ 130 cm ↗ 75 cm ↑ 190 cm</p>			
Tambour door: aluminium, custom RAL/NCS colour		120 kg	6499.-	6189.-

Bestell-Nr. N° de commande Reference no.	Zubehör	Accessoires
	Mehrpreis für Rückwand und Seiten innen: Holzwerkstoff in Sonderfarbe lackiert RAL/NCS	Supplément pour le panneau arrière et les côtés intérieurs: bois composite de couleur spéciale RAL/NCS
79-331-400		

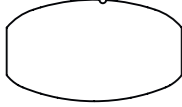
Ersatzteile	Pièces de rechange
	Ersatztablar, Farbe: Holzwerkstoff schwarz beschichtet Grösse: 105.8 x 62 cm h= 1.9 cm Kabeldurchlass: gerundete Aussparung mittig/rechts Tablarträger: höhenverstellbar (Raster: 3.5 cm)
79-010-321	Étagère de remplacement, couleur: bois composite noir, dimensions: 105.8 x 62 cm h= 1.9 cm Passage de câbles: arrondi centré/à droite Support d'étagère: réglable en hauteur (pas: 3.5 cm)

	Ersatzkleiderstange mit 2 Haken Farbe: Stahl pulverbeschichtet jetblack	Tringle à vêtements de rechange avec 2 crochets Couleur: acier revêtu par poudre jetblack
79-014-451		

	Ersatzhaken, 2 Stück Farbe: Stahl pulverbeschichtet jetblack Grösse: 5 cm	Crochets de rechange, 2 pièces Couleur: acier revêtu par poudre jetblack Dimension: 5 cm
79-018-451		

Accessories	Verpackungsmasse Dimensions de l'emballage Package dimensions	Gewicht Poids Weight	CHF	EUR
Surcharge for back and side wall: engineered wood in custom RAL/NCS colour			499.-	479.-
Spare parts				
Replacement shelf, Colour: Engineered wood, black coated Dimensions: 105.8 x 62 cm h= 1.9 cm Cable grommet: round opening Shelf supports: height adjustable (in 3.5 cm increments)	→ 108 cm ↗ 64 cm ↑ 2.5 cm	6 kg	209.-	199.-
Replacement clothes rail with 2 hooks Colour: steel, black powder coated	→ 90 cm ↗ 1 cm ↑ 1 cm	3 kg	349.-	319.-
Replacement hooks, 2 pieces Colour: steel, black powder coated Dimensions: 5 cm			89.-	89.-

Design:
Christophe Marchand
2021



Masse in cm
Dimensions en cm
Dimensions in cm

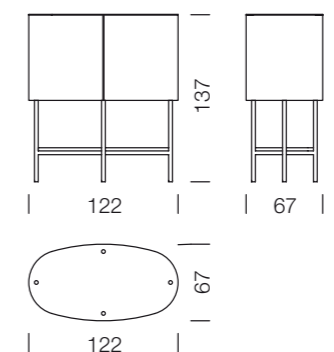



Bestell-Nr. N° de commande Reference no.	Ausführung, Farbe & Material	Finition, matériau & couleur
	<p>Korpus: Holzwerkstoff schwarz Mittelwand: Holzwerkstoff schwarz mit Kabeldurchlass (gerundete Aussparung unten) Boden: Holzwerkstoff schwarz mit Kabeldurchführung Kunststoff schwarz (rechts von Mittelwand) d= 7 / 5.5 cm Rückwand / Seiten: Holzwerkstoff schwarz Abdeckung: Klarglas schwarz unterlackiert Fuss: Stahl pulverbeschichtet jetblack, Fusshöhe: 69 cm Innenausstattung: 2 x Tablar rechts/links höhenverstellbar (Raster: 9.6 cm) mit Kabeldurchlass (gerundete Aussparung in der Ecke)</p>	<p>Corps: bois composite noir Cloison centrale: bois composite noir avec passage de câbles (évidement arrondi en bas) Base: bois composite noir avec passage de câbles en plastique noir (à droite de la cloison centrale) d= 7 / 5.5 cm Panneau arrière / côtés: bois composite noir, dessus: verre transparent au dessous laqué noir Pied: acier revêtu par poudre jetblack, hauteur du pied: 69 cm Aménagement intérieur: 2 étagères droite/gauche réglables en hauteur (pas: 9.6 cm) avec passage de câbles (arrondi dans le coin)</p>
81-002-321-571-014-451	Rollfront: Aluminium schwarz eloxiert	Porte coulissante: aluminium anodisé noir





	<p>Korpus: Holzwerkstoff schwarz Mittelwand: Holzwerkstoff schwarz mit Kabeldurchlass (gerundete Aussparung unten) Boden: Holzwerkstoff schwarz mit Kabeldurchführung Kunststoff schwarz (rechts von Mittelwand) d= 7 / 5.5 cm Rückwand / Seiten: Holzwerkstoff schwarz Abdeckung: Klarglas schwarz unterlackiert Fuss: Stahl pulverbeschichtet jetblack, Fusshöhe: 69 cm Innenausstattung: 2 x Tablar rechts/links höhenverstellbar (Raster: 9.6 cm) mit Kabeldurchlass (gerundete Aussparung in der Ecke)</p>	<p>Corps: bois composite noir Cloison centrale: bois composite noir avec passage de câbles (évidement arrondi en bas) Base: bois composite noir avec passage de câbles en plastique noir (à droite de la cloison centrale) d= 7 / 5.5 cm Panneau arrière / côtés: bois composite noir, dessus: verre transparent au dessous laqué noir Pied: acier revêtu par poudre jetblack, hauteur du pied: 69 cm Aménagement intérieur: 2 étagères droite/gauche réglables en hauteur (pas: 9.6 cm) avec passage de câbles (arrondi dans le coin)</p>
81-002-321-571-013-451	Rollfront: Aluminium natur eloxiert	Porte coulissante: aluminium anodisé naturel

Finish, material & colour	Verpackungsmasse Dimensions de l'emballage Package dimensions	Gewicht Poids Weight	CHF	EUR
<p>Base unit: engineered wood, black Centre wall: engineered wood, black, with cable grommet (round opening, bottom) Base: engineered wood, black, with black plastic cable grommet (right of centre wall) d= 7 / 5.5 cm Back wall / sides: engineered wood black Top cover: clear glass, black-lacquered underside Feet: steel, powder-coated jetblack, Foot height: 69 cm Interior: 2x shelves, right/left height adjustable (in 9.6 cm increments) with cable grommet (rounded recess in the corner)</p>	<p>→ 130 cm ↗ 75 cm ↑ 145 cm</p>			
Tambour door: aluminium, black anodized		90 kg	4299.-	4099.-
<p>Base unit: engineered wood, black Centre wall: engineered wood, black coated, with cable grommet (round opening, bottom) Base: engineered wood, black, with black plastic cable grommet (right of centre wall) d= 7 / 5.5 cm Back wall / sides: engineered wood black Top cover: clear glass, black-lacquered underside Feet: steel, powder-coated jetblack, Foot height: 69 cm Interior: 2x shelves, right/left height adjustable (in 9.6 cm increments) with cable grommet (rounded recess in the corner)</p>	<p>→ 130 cm ↗ 75 cm ↑ 145 cm</p>			
Tambour door: aluminium, natural anodized		90 kg	4299.-	4099.-

Preise: UVP exkl. MwSt.
Prix: prix de vente
conseillés hors TVA
Prices: RRP ex. VAT

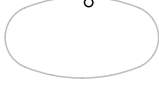
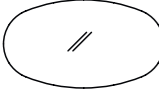
Bestell-Nr. N° de commande Reference no.	Ausführung, Farbe & Material	Finition, matériau & couleur
	<p>Korpus: Holzwerkstoff schwarz Mittelwand: Holzwerkstoff schwarz mit Kabeldurchlass (gerundete Aussparung unten) Boden: Holzwerkstoff schwarz mit Kabeldurchführung Kunststoff schwarz (rechts von Mittelwand) d= 7 / 5.5 cm Rückwand / Seiten: Holzwerkstoff schwarz Abdeckung: Klarglas schwarz unterlackiert Fuss: Stahl pulverbeschichtet jetblack, Fusshöhe: 69 cm Innenausstattung: 2 x Tablar rechts/links höhenverstellbar (Raster: 9.6 cm) mit Kabeldurchlass (gerundete Aussparung in der Ecke)</p>	<p>Corps: bois composite noir Cloison centrale: bois composite noir avec passage de câbles (évidement arrondi en bas) Base: bois composite noir avec passage de câbles en plastique noir (à droite de la cloison centrale) d= 7 / 5.5 cm Panneau arrière / côtés: bois composite noir, dessus: verre transparent au dessous laqué noir Pied: acier revêtu par poudre jetblack, hauteur du pied: 69 cm Aménagement intérieur: 2 étagères droite/gauche réglables en hauteur (pas: 9.6 cm) avec passage de câbles (arrondi dans le coin)</p>
81-002-321-571-015-451	Rollfront: Aluminium champagner eloxiert	Porte coulissante: aluminium anodisé champagne
	<p>Korpus: Holzwerkstoff schwarz Mittelwand: Holzwerkstoff schwarz mit Kabeldurchlass (gerundete Aussparung unten) Boden: Holzwerkstoff schwarz mit Kabeldurchführung Kunststoff schwarz (rechts von Mittelwand) d= 7 / 5.5 cm Rückwand / Seiten: Holzwerkstoff schwarz Abdeckung: Klarglas schwarz unterlackiert Fuss: Stahl pulverbeschichtet jetblack, Fusshöhe: 69 cm Innenausstattung: 2 x Tablar rechts/links höhenverstellbar (Raster: 9.6 cm) mit Kabeldurchlass (gerundete Aussparung in der Ecke)</p>	<p>Corps: bois composite noir Cloison centrale: bois composite noir avec passage de câbles (évidement arrondi en bas) Base: bois composite noir avec passage de câbles en plastique noir (à droite de la cloison centrale) d= 7 / 5.5 cm Panneau arrière / côtés: bois composite noir, dessus: verre transparent au dessous laqué noir Pied: acier revêtu par poudre jetblack, hauteur du pied: 69 cm Aménagement intérieur: 2 étagères droite/gauche réglables en hauteur (pas: 9.6 cm) avec passage de câbles (arrondi dans le coin)</p>
81-002-321-571-400-451	Rollfront: Aluminium in Sonderfarbe lackiert RAL/NCS	Porte coulissante: aluminium couleur spéciale RAL/NCS

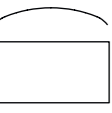
Finish, material & colour	Verpackungsmasse Dimensions de l'emballage Package dimensions	Gewicht Poids Weight	CHF	EUR
<p>Base unit: engineered wood, black Centre wall: engineered wood, black coated, with cable grommet (round opening, bottom) Base: engineered wood, black, with black plastic cable grommet (right of centre wall) d= 7 / 5.5 cm Back wall / sides: engineered wood black Top cover: clear glass, black-lacquered underside Feet: steel, powder-coated jetblack, Foot height: 69 cm Interior: 2x shelves, right/left height adjustable (in 9.6 cm increments) with cable grommet (rounded recess in the corner)</p>	<p>→ 130 cm ↗ 75 cm ↑ 145 cm</p>			
Tambour door: aluminium, champagne anodized		90 kg	4299.-	4099.-
<p>Base unit: engineered wood, black Centre wall: engineered wood, black coated, with cable grommet (round opening, bottom) Base: engineered wood, black, with black plastic cable grommet (right of centre wall) d= 7 / 5.5 cm Back wall / sides: engineered wood black Top cover: clear glass, black-lacquered underside Feet: steel, powder-coated jetblack, Foot height: 69 cm Interior: 2x shelves, right/left height adjustable (in 9.6 cm increments) with cable grommet (rounded recess in the corner)</p>	<p>→ 130 cm ↗ 75 cm ↑ 145 cm</p>			
Tambour door: aluminium, custom RAL/NCS colour		90 kg	4949.-	4719.-

Bestell-Nr. N° de commande Reference no.	Zubehör	Accessoires
	Mehrpreis für Kabeldurchführung in Glasabdeckplatte Durchmesser: 5.5 cm Positionierung: hinten mittig/rechts	Supplément pour le passage de câbles dans le plateau en verre Diamètre: 5.5 cm Positionnement: centré/à droite à l'arrière
81-012-571		
	Mehrpreis für Glasabdeckplatte farbig unterlackiert RAL/NCS	Supplément de prix pour le plateau en verre au dessous laqué de couleur RAL/NCS
81-030-400		
Ersatzteile		Pièces de rechange
	Ersatztablar rechts/links, Farbe: Holzwerkstoff schwarz beschichtet, Grösse: 51.9 x 61.1 cm h= 1.9 cm Kabeldurchlass: gerundete Aussparung in der Ecke Tablarträger: höhenverstellbar (Raster: 9.6 cm)	Étagère de rechange droit/gauche, couleur: bois composite noir, dimensions: 51.9 x 61.1 cm h= 1.9 cm Passage de câbles: arrondi dans le coin Support d'étagère: réglable en hauteur (pas: 9.6 cm)
81-011-321		
	Spiegelfolie Rückwand innen	Film miroir panneau arrière intérieur
81-021-045		
	Platte für Auflage auf Untergestell Farbe: Holzwerkstoff schwarz beschichtet Grösse: 106 x 51 cm h= 1.9 cm	Plateau pour support sur piètement Couleur: bois composite noir Dimensions: 106 x 51 cm h= 1.9 cm
81-009-321		
	Ersatzglasabdeckplatte Farbe: Klarglas schwarz unterlackiert	Plateau de verre de rechange Couleur: verre transparent au dessous laqué noir
81-030-571		

Accessories	Verpackungsmasse Dimensions de l'emballage Package dimensions	Gewicht Poids Weight	CHF	EUR
Surcharge for cable grommet in glass cover plate Diameter: 5.5 cm Positioning: back centre/right			99.-	99.-
Surcharge for glass cover plate with underside lacquered in RAL/NCS colour			539.-	519.-
Spare parts				
Replacement shelf right/left, Colour: Engineered wood, black, dimensions: 51.9 x 61.1 cm h= 1.9 cm Cable grommet: rounded recess (in the corner) Shelf supports: height adjustable (in 9.6 cm increments)	→ 55 cm ↗ 63 cm ↑ 2.5 cm	2 kg	109.-	109.-
Mirror foil, interior back wall			299.-	289.-
Shelf for support on base frame Colour: Engineered wood, black Dimensions: 106 x 51 cm h= 1.9 cm	→ 109 cm ↗ 55 cm ↑ 2.5 cm	6 kg	219.-	209.-
Replacement glass cover Colour: clear glass, black-lacquered underside	→ 130 cm ↗ 75 cm ↑ 2.5 cm	13 kg	479.-	459.-

Preise: UVP exkl. MwSt.
Prix: prix de vente
conseillés hors TVA
Prices: RRP ex. VAT

Design:
Christophe Marchand
2021



Masse in cm
Dimensions en cm
Dimensions in cm

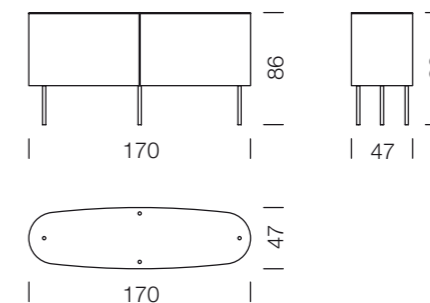

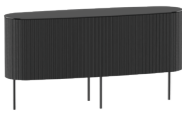
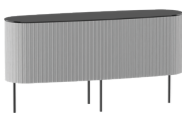

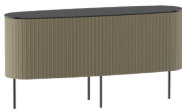
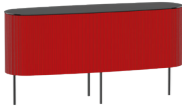

Bestell-Nr. N° de commande Reference no.	Ausführung, Farbe & Material	Finition, matériau & couleur
	<p>Korpus: Holzwerkstoff schwarz Mittelwände: Holzwerkstoff schwarz mit Kabeldurchlass (gerundete Aussparung unten) Boden: Holzwerkstoff schwarz mit Kabeldurchführung (hinten mittig) Kunststoff Schwarz, d= 7 / 5.5 cm Rückwand / Seiten: Holzwerkstoff schwarz lackiert Abdeckung: Klarglas schwarz unterlackiert Fuss: Stahl pulverbeschichtet jetblack, Fusshöhe: 30 cm Innenausstattung: 1 x Tablar mitte höhenverstellbar (Raster: 9.6 cm) mit Kabeldurchlass (gerundete Aussparung hinten) 2 x Tablar rechts/links höhenverstellbar (Raster: 9.6 cm) mit Kabeldurchlass (gerundete Aussparung in der Ecke)</p>	<p>Corps: bois composite noir Cloisons centrales: bois composite noir avec passage de câbles (évidement arrondi en bas) Base: bois composite noir avec passage de câbles en plastique noir (centré à l'arrière) d= 7 / 5.5 cm Panneau arrière / côtés: bois composite noir, dessus: verre transparent au dessous laqué noir Pied: acier revêtu par poudre jetblack, hauteur du pied: 30 cm Aménagement intérieur: 1 étagère centrale réglables en hauteur (pas: 9.6 cm) avec passage de câbles (arrondi à l'arrière) 2 étagères droite/gauche réglables en hauteur (pas: 9.6 cm) avec passage de câbles (arrondi dans le coin)</p>
82-002-321-571-014-451	Rollfront: Aluminium schwarz eloxiert	Porte coulissante: aluminium anodisé noir
	<p>Korpus: Holzwerkstoff schwarz Mittelwände: Holzwerkstoff schwarz mit Kabeldurchlass (gerundete Aussparung unten) Boden: Holzwerkstoff schwarz mit Kabeldurchführung (hinten mittig) Kunststoff Schwarz, d= 7 / 5.5 cm Rückwand / Seiten: Holzwerkstoff schwarz lackiert Abdeckung: Klarglas schwarz unterlackiert Fuss: Stahl pulverbeschichtet jetblack, Fusshöhe: 30 cm Innenausstattung: 1 x Tablar mitte höhenverstellbar (Raster: 9.6 cm) mit Kabeldurchlass (gerundete Aussparung hinten) 2 x Tablar rechts/links höhenverstellbar (Raster: 9.6 cm) mit Kabeldurchlass (gerundete Aussparung in der Ecke)</p>	<p>Corps: bois composite noir Cloisons centrales: bois composite noir avec passage de câbles (évidement arrondi en bas) Base: bois composite noir avec passage de câbles en plastique noir (centré à l'arrière) d= 7 / 5.5 cm Panneau arrière / côtés: bois composite noir, dessus: verre transparent au dessous laqué noir Pied: acier revêtu par poudre jetblack, hauteur du pied: 30 cm Aménagement intérieur: 1 étagère centrale réglables en hauteur (pas: 9.6 cm) avec passage de câbles (arrondi à l'arrière) 2 étagères droite/gauche réglables en hauteur (pas: 9.6 cm) avec passage de câbles (arrondi dans le coin)</p>
82-002-321-571-013-451	Rollfront: Aluminium natur eloxiert	Porte coulissante: aluminium anodisé naturel

Finish, material & colour	Verpackungsmasse Dimensions de l'emballage Package dimensions	Gewicht Poids Weight	CHF	EUR
<p>Base unit: engineered wood, black Centre walls: engineered wood, black coated, with cable grommet (round opening, bottom) Base: engineered wood, black, with black plastic cable grommet (centre back) d= 7 / 5.5 cm Back wall / sides: engineered wood, black lacquered Top cover: clear glass, black-lacquered underside Feet: steel, powder-coated jetblack, Foot height: 30 cm Interior: 1x shelf, height adjustable (in 9.6 cm increments) with cable grommet (round opening, back centre/right) → 180 cm 2x shelves, right/left height adjustable (in 9.6 cm increments) with cable grommet (rounded recess in the corner) ↗ 60 cm ↑ 98 cm</p>				
Tambour door: aluminium, black anodized		101 kg	4599.-	4389.-
<p>Base unit: engineered wood, black Centre walls: engineered wood, black coated, with cable grommet (round opening, bottom) Base: engineered wood, black, with black plastic cable grommet (centre back) d= 7 / 5.5 cm Back wall / sides: engineered wood, black lacquered Top cover: clear glass, black-lacquered underside Feet: steel, powder-coated jetblack, Foot height: 30 cm Interior: 1x shelf, height adjustable (in 9.6 cm increments) with cable grommet (round opening, back centre/right) → 180 cm 2x shelves, right/left height adjustable (in 9.6 cm increments) with cable grommet (rounded recess in the corner) ↗ 60 cm ↑ 98 cm</p>				
Tambour door: aluminium, natural anodized		101 kg	4599.-	4389.-

Preise: UVP exkl. MwSt.
Prix: prix de vente
conseillés hors TVA
Prices: RRP ex. VAT

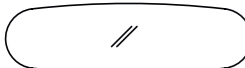
Bestell-Nr. N° de commande Reference no.	Ausführung, Farbe & Material	Finition, matériau & couleur
	<p>Korpus: Holzwerkstoff schwarz Mittelwände: Holzwerkstoff schwarz mit Kabeldurchlass (gerundete Aussparung unten) Boden: Holzwerkstoff schwarz mit Kabeldurchführung (hinten mittig) Kunststoff Schwarz, d= 7 / 5.5 cm Rückwand / Seiten: Holzwerkstoff schwarz lackiert Abdeckung: Klarglas schwarz unterlackiert Fuss: Stahl pulverbeschichtet jetblack, Fushöhe: 30 cm Innenausstattung: 1 x Tablar mitte höhenverstellbar (Raster: 9.6 cm) mit Kabeldurchlass (gerundete Aussparung hinten) 2 x Tablar rechts/links höhenverstellbar (Raster: 9.6 cm) mit Kabeldurchlass (gerundete Aussparung in der Ecke)</p>	<p>Corps: bois composite noir Cloisons centrales: bois composite noir avec passage de câbles (évidement arrondi en bas) Base: bois composite noir avec passage de câbles (centré à l'arrière) en plastique noir, d= 7 / 5.5 cm Panneau arrière / côtés: bois composite noir, dessus: verre transparent au dessous laqué noir; Pied: acier revêtu par poudre jetblack, hauteur du pied: 30 cm Aménagement intérieur: 1 étagère centrale réglables en hauteur (pas: 9.6 cm) avec passage de câbles (arrondi à l'arrière) 2 étagères droite/gauche réglables en hauteur (pas: 9.6 cm) avec passage de câbles (arrondi dans le coin)</p>
82-002-321-571-015-451	Rollfront: Aluminium champagner eloxiert	Porte coulissante: aluminium anodisé champagne
	<p>Korpus: Holzwerkstoff schwarz Mittelwände: Holzwerkstoff schwarz mit Kabeldurchlass (gerundete Aussparung unten) Boden: Holzwerkstoff schwarz mit Kabeldurchführung (hinten mittig) Kunststoff Schwarz, d= 7 / 5.5 cm Rückwand / Seiten: Holzwerkstoff schwarz lackiert Abdeckung: Klarglas schwarz unterlackiert Fuss: Stahl pulverbeschichtet jetblack, Fushöhe: 30 cm Innenausstattung: 1 x Tablar mitte höhenverstellbar (Raster: 9.6 cm) mit Kabeldurchlass (gerundete Aussparung hinten) 2 x Tablar rechts/links höhenverstellbar (Raster: 9.6 cm) mit Kabeldurchlass (gerundete Aussparung in der Ecke)</p>	<p>Corps: bois composite noir Cloisons centrales: bois composite noir avec passage de câbles (évidement arrondi en bas) Base: bois composite noir avec passage de câbles (centré à l'arrière) en plastique noir, d= 7 / 5.5 cm Panneau arrière / côtés: bois composite noir, dessus: verre transparent au dessous laqué noir; Pied: acier revêtu par poudre jetblack, hauteur du pied: 30 cm Aménagement intérieur: 1 étagère centrale réglables en hauteur (pas: 9.6 cm) avec passage de câbles (arrondi à l'arrière) 2 étagères droite/gauche réglables en hauteur (pas: 9.6 cm) avec passage de câbles (arrondi dans le coin)</p>
82-001-321-571-400-451	Rollfront: Aluminium in Sonderfarbe lackiert RAL/NCS	Porte coulissante: aluminium couleur spéciale RAL/NCS

Finish, material & colour	Verpackungsmasse Dimensions de l'emballage Package dimensions	Gewicht Poids Weight	CHF	EUR
<p>Base unit: engineered wood, black Centre walls: engineered wood, black coated, with cable grommet (round opening, bottom) Base: engineered wood, black, with black plastic cable grommet (centre back) d= 7 / 5.5 cm Back wall / sides: engineered wood, black lacquered Top cover: clear glass, black-lacquered underside Feet: steel, powder-coated jetblack, Foot height: 30 cm Interior: 1x shelf, height adjustable (in 9.6 cm increments) → 180 cm with cable grommet (round opening, back centre/right) ↗ 60 cm 2x shelves, right/left height adjustable (in 9.6 cm increments) ↑ 98 cm with cable grommet (rounded recess in the corner)</p>				
Tambour door: aluminium, champagne anodized		101 kg	4599.-	4389.-
<p>Base unit: engineered wood, black Centre walls: engineered wood, black coated, with cable grommet (round opening, bottom) Base: engineered wood, black, with black plastic cable grommet (centre back) d= 7 / 5.5 cm Back wall / sides: engineered wood, black lacquered Top cover: clear glass, black-lacquered underside Feet: steel, powder-coated jetblack, Foot height: 30 cm Interior: 1x shelf, height adjustable (in 9.6 cm increments) → 180 cm with cable grommet (round opening, back centre/right) ↗ 60 cm 2x shelves, right/left height adjustable (in 9.6 cm increments) ↑ 98 cm with cable grommet (rounded recess in the corner)</p>				
Tambour door: aluminium, in custom RAL/NCS colour		101 kg	5049.-	4809.-

Bestell-Nr. N° de commande Reference no.	Zubehör	Accessoires
		Mehrpreis für Kabeldurchführung in Glasabdeckplatte Durchmesser: 5.5 cm Positionierung: hinten mittig/rechts
		Supplément pour le passage de câbles dans le plateau en verre Diamètre: 5.5 cm Positionnement: centré/à droite à l'arrière
82-012-571		
		Mehrpreis für Glasabdeckplatte farbig unterlackiert RAL/NCS
		Supplément de prix pour le plateau en verre au dessous laqué de couleur RAL/NCS
82-030-400		
Ersatzteile		Pièces de rechange
		Ersatztablar mitte, Farbe: Holzwerkstoff schwarz beschichtet, Grösse: 69 x 45.7 cm h= 1.9 cm Kabeldurchlass: gerundete Aussparung (hinten) Tablarträger: höhenverstellbar (Raster: 3.5 cm)
		Étagère de rechange au milieu, couleur: bois composite noir, dimensions: 69 x 45.7 cm h= 1.9 cm; Passage de câbles: arrondi (à l'arrière) Support d'étagère: réglable en hauteur (pas: 3.5 cm)
82-010-321		
		Ersatztablar recht/links, Farbe: Holzwerkstoff schwarz beschichtet, Grösse: 40.3 x 45.7 cm h= 1.9 cm Kabeldurchlass: gerundete Aussparung (hinten) Tablarträger: höhenverstellbar (Raster: 3.5 cm)
		Étagère de rechange droite/gauche, couleur: bois composite noir, dimensions: 40.3 x 45.7 cm h= 1.9 cm; Passage de câbles: arrondi dans le coin Support d'étagère: réglable en hauteur (pas: 3.5 cm)
82-011-321		
		Ersatzglasabdeckplatte Farbe: Klarglas schwarz unterlackiert
		Plateau de verre de rechange Couleur: verre transparent au dessous laqué noir
82-030-571		

Accessories	Verpackungsmasse Dimensions de l'emballage Package dimensions	Gewicht Poids Weight	CHF	EUR
Surcharge for cable grommet in glass cover plate Diameter: 5.5 cm Positioning: back centre/right			99.-	99.-
Surcharge for glass cover plate with underside lacquered in RAL/NCS colour			549.-	529.-
Spare parts				
Replacement shelf middle, Colour: Engineered wood, black, dimensions: 69 x 45.7 cm h= 1.9 cm Cable grommet: round opening (back) Shelf supports: height adjustable (in 3.5 cm increments)	→ 72 cm ↗ 47 cm ↑ 2.5 cm	3 kg	139.-	139.-
Replacement shelf right/left, Colour: Engineered wood, black, dimensions: 40.3 x 45.7 cm h= 1.9 cm Cable grommet: rounded recess (in the corner) Shelf supports: height adjustable (in 3.5 cm increments)	→ 43 cm ↗ 44 cm ↑ 2.5 cm	2 kg	109.-	109.-
Replacement glass cover Colour: clear glass, black-lacquered underside	→ 180 cm ↗ 60 cm ↑ 2.5 cm	15 kg	549.-	529.-

Design:
Christophe Marchand
2021





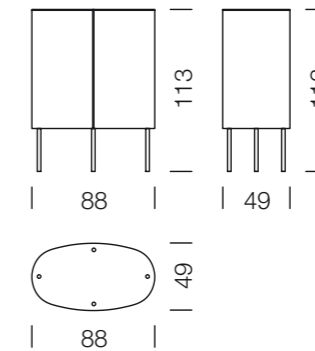

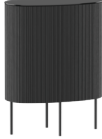
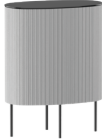
Masse in cm
Dimensions en cm
Dimensions in cm

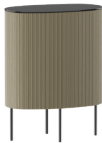
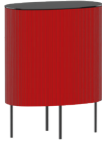

Bestell-Nr. N° de commande Reference no.	Ausführung, Farbe & Material	Finition, matériau & couleur	Finish, material & colour	Verpackungsmasse Dimensions de l'emballage Package dimensions	Gewicht Poids Weight	CHF	EUR
	 <p>Korpus: Holzwerkstoff schwarz Boden: Holzwerkstoff schwarz mit Kabeldurchführung Kunststoff schwarz (hinten) d= 7 / 5.5cm Rückwand / Seiten: Holzwerkstoff schwarz lackiert Abdeckung: Klarglas schwarz unterlackiert Fuss: Stahl pulverbeschichtet jetblack, Fushöhe: 30 cm Innenausstattung: 1 x Tablar höhenverstellbar (Raster: 9.6 cm) mit Kabeldurchlass (gerundete Aussparung hinten mitte)</p>	<p>Corps: bois composite noir Base: bois composite noir avec passage de câbles en plastique noir (à l'arrière) d= 7 / 5.5 cm Panneau arrière / côtés: bois composite noir Dessus: verre transparent au dessous laqué noir Pied: acier revêtu par poudre jetblack Hauteur du pied: 30 cm Aménagement intérieur: 1 étagère réglable en hauteur (pas: 9.6 cm) avec passage de câbles (arrondi à l'arrière au milieu)</p>	<p>Base unit: engineered wood, black Base: engineered wood, black, with black plastic cable grommet (centre back) d= 7 / 5.5 cm Back wall / sides: engineered wood, black lacquered Top cover: clear glass, black-lacquered underside Feet: steel, powder-coated jetblack, Foot height: 30 cm Interior: 1x shelf, height adjustable (in 9.6 cm increments) with cable grommet (rounded recess in the middle)</p>	<p>→ 95 cm ↗ 60 cm ↑ 126 cm</p>			
83-002-321-571-014-451	Rollfront: Aluminium schwarz eloxiert	Porte coulissante: aluminium anodisé noir	Tambour door: aluminium, black anodized		58 kg	3549.-	3389.-
	 <p>Korpus: Holzwerkstoff schwarz Boden: Holzwerkstoff schwarz mit Kabeldurchführung Kunststoff schwarz (hinten) d= 7 / 5.5cm Rückwand / Seiten: Holzwerkstoff schwarz lackiert Abdeckung: Klarglas schwarz unterlackiert Fuss: Stahl pulverbeschichtet jetblack, Fushöhe: 30 cm Innenausstattung: 1 x Tablar höhenverstellbar (Raster: 9.6 cm) mit Kabeldurchlass (gerundete Aussparung hinten mitte)</p>	<p>Corps: bois composite noir Base: bois composite noir avec passage de câbles en plastique noir (à l'arrière) d= 7 / 5.5 cm Panneau arrière / côtés: bois composite noir Dessus: verre transparent au dessous laqué noir Pied: acier revêtu par poudre jetblack Hauteur du pied: 30 cm Aménagement intérieur: 1 étagère réglable en hauteur (pas: 9.6 cm) avec passage de câbles (arrondi à l'arrière au milieu)</p>	<p>Base unit: engineered wood, black Base: engineered wood, black, with black plastic cable grommet (centre back) d= 7 / 5.5 cm Back wall / sides: engineered wood, black lacquered Top cover: clear glass, black-lacquered underside Feet: steel, powder-coated jetblack, Foot height: 30 cm Interior: 1x shelf, height adjustable (in 9.6 cm increments) with cable grommet (rounded recess in the middle)</p>	<p>→ 95 cm ↗ 60 cm ↑ 126 cm</p>			
83-002-321-571-013-451	Rollfront: Aluminium natur eloxiert	Porte coulissante: aluminium anodisé naturel	Tambour door: aluminium, natural anodized		58 kg	3549.-	3389.-

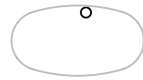
Bestell-Nr. N° de commande Reference no.	Ausführung, Farbe & Material	Finition, matériau & couleur
	<p>Korpus: Holzwerkstoff schwarz Boden: Holzwerkstoff schwarz mit Kabeldurchführung Kunststoff schwarz (hinten) d= 7 / 5.5cm Rückwand / Seiten: Holzwerkstoff schwarz lackiert Abdeckung: Klarglas schwarz unterlackiert Fuss: Stahl pulverbeschichtet jetblack, Fusshöhe: 30 cm Innenausstattung: 1 x Tablar höhenverstellbar (Raster: 9.6 cm) mit Kabeldurchlass (gerundete Aussparung hinten mitte)</p>	<p>Corps: bois composite noir Base: bois composite noir avec passage de câbles en plastique noir (à l'arrière) d= 7 / 5.5 cm Panneau arrière / côtés: bois composite noir Dessus: verre transparent au dessous laqué noir Pied: acier revêtu par poudre jetblack Hauteur du pied: 30 cm Aménagement intérieur: 1 étagère réglable en hauteur (pas: 9.6 cm) avec passage de câbles (arrondi à l'arrière au milieu)</p>
83-002-321-571-015-451	Rollfront: Aluminium champagner eloxiert	Porte coulissante: aluminium anodisé champagne
	<p>Korpus: Holzwerkstoff schwarz Boden: Holzwerkstoff schwarz mit Kabeldurchführung Kunststoff schwarz (hinten) d= 7 / 5.5cm Rückwand / Seiten: Holzwerkstoff schwarz lackiert Abdeckung: Klarglas schwarz unterlackiert Fuss: Stahl pulverbeschichtet jetblack, Fusshöhe: 30 cm Innenausstattung: 1 x Tablar höhenverstellbar (Raster: 9.6 cm) mit Kabeldurchlass (gerundete Aussparung hinten mitte)</p>	<p>Corps: bois composite noir Base: bois composite noir avec passage de câbles en plastique noir (à l'arrière) d= 7 / 5.5 cm Panneau arrière / côtés: bois composite noir Dessus: verre transparent au dessous laqué noir Pied: acier revêtu par poudre jetblack Hauteur du pied: 30 cm Aménagement intérieur: 1 étagère réglable en hauteur (pas: 9.6 cm) avec passage de câbles (arrondi à l'arrière au milieu)</p>
83-002-321-331-400-451	Rollfront: Aluminium in Sonderfarbe lackiert RAL/NCS	Porte coulissante: aluminium couleur spéciale RAL/NCS

Finish, material & colour	Verpackungsmasse Dimensions de l'emballage Package dimensions	Gewicht Poids Weight	CHF	EUR
<p>Base unit: engineered wood, black Base: engineered wood, black, with black plastic cable grommet (centre back) d= 7 / 5.5 cm Back wall / sides: engineered wood, black lacquered Top cover: clear glass, black-lacquered underside Feet: steel, powder-coated jetblack, Foot height: 30 cm Interior: 1x shelf, height adjustable (in 9.6 cm increments) with cable grommet (rounded recess in the middle)</p>	<p>→ 95 cm ↗ 60 cm ↑ 126 cm</p>	58 kg	3549.-	3389.-
Tambour door: aluminium, champagne anodized				
<p>Base unit: engineered wood, black Base: engineered wood, black, with black plastic cable grommet (centre back) d= 7 / 5.5 cm Back wall / sides: engineered wood, black lacquered Top cover: clear glass, black-lacquered underside Feet: steel, powder-coated jetblack, Foot height: 30 cm Interior: 1x shelf, height adjustable (in 9.6 cm increments) with cable grommet (rounded recess in the middle)</p>	<p>→ 95 cm ↗ 60 cm ↑ 126 cm</p>	58 kg	4289.-	4089.-
Tambour door: aluminium, custom RAL/NCS colour				

Bestell-Nr. N° de commande Reference no.	Zubehör	Accessoires
	Mehrpreis für Kabeldurchführung in Glasabdeckplatte Durchmesser: 5.5 cm Positionierung: hinten mittig/rechts	Supplément pour le passage de câbles dans le plateau en verre Diamètre: 5.5 cm Positionnement: centré/à droite à l'arrière
83-012-800		
	Mehrpreis für Glasabdeckplatte farbig unterlackiert RAL/NCS	Supplément de prix pour le plateau en verre au dessous laqué de couleur RAL/NCS
83-030-400		
Ersatzteile		Pièces de rechange
	Ersattablar, Farbe: Holzwerkstoff schwarz beschichtet Grösse: 69 x 45.7 cm h= 1.9 cm Kabeldurchlass: gerundete Aussparung hinten Tablarträger: höhenverstellbar (Raster: 4.5 cm)	Étagère de remplacement, couleur: bois composite revêtu de noir, dimensions: 69 x 45.7 cm h= 1.9 cm Passage de câbles: arrondi (à l'arrière) Support d'étagère: réglable en hauteur (pas: 4.5 cm)
83-010-321		
	Ersatzglasabdeckplatte, Farbe: Klarglas schwarz unterlackiert	Plateau de verre de rechange Couleur: verre transparent au dessous laqué noir
83-030-571		

Accessories	Verpackungsmasse Dimensions de l'emballage Package dimensions	Gewicht Poids Weight	CHF	EUR
Surcharge for cable grommet in glass cover plate Diameter: 5.5 cm Positioning: back centre/right			99.-	99.-
Surcharge for glass cover plate with underside lacquered in RAL/NCS colour			549.-	529.-
Spare parts				
Replacement shelf, Colour: Engineered wood, black Dimensions: 69 x 45.7 cm h= 1.9 cm Cable grommet: round opening (back) Shelf supports: height adjustable (in 4.5 cm increments)	→ 72 cm ↗ 47 cm ↑ 2.5 cm	3 kg	119.-	119.-
Replacement glass cover Colour: clear glass, black-lacquered underside	→ 95 cm ↗ 60 cm ↑ 2.5 cm	5 kg	379.-	369.-

Preise: UVP exkl. MwSt.
Prix: prix de vente
conseillés hors TVA
Prices: RRP ex. VAT

Design:
Christophe Marchand
2021



Masse in cm
Dimensions en cm
Dimensions in cm

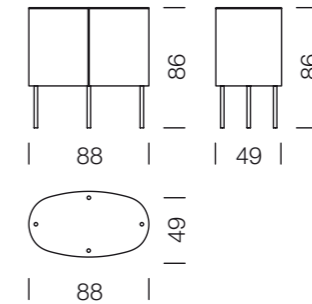

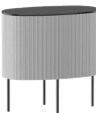

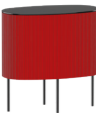

Bestell-Nr. N° de commande Reference no.	Ausführung, Farbe & Material	Finition, matériau & couleur
	<p>Korpus: Holzwerkstoff schwarz Boden: Holzwerkstoff schwarz mit Kabeldurchführung Kunststoff schwarz (hinten) d= 7 / 5.5 cm Rückwand / Seiten: Holzwerkstoff schwarz Abdeckung: Klarglas schwarz unterlackiert Fuss: Stahl pulverbeschichtet jetblack, Fushöhe: 30 cm Innenausstattung: 1 x Tablar höhenverstellbar (Raster: 9.6 cm) mit Kabeldurchlass (gerundete Aussparung hinten mitte)</p>	<p>Corps: bois composite noir Base: bois composite noir avec passage de câbles en plastique noir (à l'arrière) d= 7 / 5.5 cm Panneau arrière / côtés: bois composite noir Dessus: verre transparent au dessous laqué noir Pied: acier revêtu par poudre jetblack Hauteur du pied: 30 cm Aménagement intérieur: 1 étagère réglable en hauteur (pas: 9.6 cm) avec passage de câbles (arrondi à l'arrière au milieu)</p>
84-002-321-571-014-451	Rollfront: Aluminium schwarz eloxiert	Porte coulissante: aluminium anodisé noir
	<p>Korpus: Holzwerkstoff schwarz Boden: Holzwerkstoff schwarz mit Kabeldurchführung Kunststoff schwarz (hinten) d= 7 / 5.5 cm Rückwand / Seiten: Holzwerkstoff schwarz Abdeckung: Klarglas schwarz unterlackiert Fuss: Stahl pulverbeschichtet jetblack, Fushöhe: 30 cm Innenausstattung: 1 x Tablar höhenverstellbar (Raster: 9.6 cm) mit Kabeldurchlass (gerundete Aussparung hinten mitte)</p>	<p>Corps: bois composite noir Base: bois composite noir avec passage de câbles en plastique noir (à l'arrière) d= 7 / 5.5 cm Panneau arrière / côtés: bois composite noir Dessus: verre transparent au dessous laqué noir Pied: acier revêtu par poudre jetblack Hauteur du pied: 30 cm Aménagement intérieur: 1 étagère réglable en hauteur (pas: 9.6 cm) avec passage de câbles (arrondi à l'arrière au milieu)</p>
84-002-321-571-013-451	Rollfront: Aluminium natur eloxiert	Porte coulissante: aluminium anodisé naturel

Finish, material & colour	Verpackungsmasse Dimensions de l'emballage Package dimensions	Gewicht Poids Weight	CHF	EUR
<p>Base unit: engineered wood, black Base: engineered wood, black, with black plastic cable grommet (centre back) d= 7 / 5.5 cm Back wall / sides: engineered wood black Top cover: clear glass, black-lacquered underside Feet: steel, powder-coated jetblack, Foot height: 30 cm Interior: 1x shelf, height adjustable (in 9.6 cm increments) with cable grommet (rounded recess in the middle)</p>	<p>→ 95 cm ↗ 60 cm ↑ 98 cm</p>	53 kg	3199.-	3049.-
Tambour door: aluminium, black anodized				
<p>Base unit: engineered wood, black Base: engineered wood, black, with black plastic cable grommet (centre back) d= 7 / 5.5 cm Back wall / sides: engineered wood black Top cover: clear glass, black-lacquered underside Feet: steel, powder-coated jetblack, Foot height: 30 cm Interior: 1x shelf, height adjustable (in 9.6 cm increments) with cable grommet (rounded recess in the middle)</p>	<p>→ 95 cm ↗ 60 cm ↑ 98 cm</p>	53 kg	3199.-	3049.-
Tambour door: aluminium, natural anodized				

Preise: UVP exkl. MwSt.
Prix: prix de vente
conseillés hors TVA
Prices: RRP ex. VAT

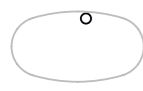
Bestell-Nr. N° de commande Reference no.	Ausführung, Farbe & Material	Finition, matériau & couleur
	<p>Korpus: Holzwerkstoff schwarz Boden: Holzwerkstoff schwarz mit Kabeldurchführung Kunststoff schwarz (hinten) d= 7 / 5.5 cm Rückwand / Seiten: Holzwerkstoff schwarz Abdeckung: Klarglas schwarz unterlackiert Fuss: Stahl pulverbeschichtet jetblack, Fusshöhe: 30 cm Innenausstattung: 1 x Tablar höhenverstellbar (Raster: 9.6 cm) mit Kabeldurchlass (gerundete Aussparung hinten mitte)</p>	<p>Corps: bois composite noir Base: bois composite noir avec passage de câbles en plastique noir (à l'arrière) d= 7 / 5.5 cm Panneau arrière / côtés: bois composite noir Dessus: verre transparent au dessous laqué noir Pied: acier revêtu par poudre jetblack Hauteur du pied: 30 cm Aménagement intérieur: 1 étagère réglable en hauteur (pas: 9.6 cm) avec passage de câbles (arrondi à l'arrière au milieu)</p>
84-002-321-571-015-451	Rollfront: Aluminium champagner eloxiert	Porte coulissante: aluminium anodisé champagne
	<p>Korpus: Holzwerkstoff schwarz Boden: Holzwerkstoff schwarz mit Kabeldurchführung Kunststoff schwarz (hinten) d= 7 / 5.5 cm Rückwand / Seiten: Holzwerkstoff schwarz Abdeckung: Klarglas schwarz unterlackiert Fuss: Stahl pulverbeschichtet jetblack, Fusshöhe: 30 cm Innenausstattung: 1 x Tablar höhenverstellbar (Raster: 9.6 cm) mit Kabeldurchlass (gerundete Aussparung hinten mitte)</p>	<p>Corps: bois composite noir Base: bois composite noir avec passage de câbles en plastique noir (à l'arrière) d= 7 / 5.5 cm Panneau arrière / côtés: bois composite noir Dessus: verre transparent au dessous laqué noir Pied: acier revêtu par poudre jetblack Hauteur du pied: 30 cm Aménagement intérieur: 1 étagère réglable en hauteur (pas: 9.6 cm) avec passage de câbles (arrondi à l'arrière au milieu)</p>
84-002-321-571-400-451	Rollfront: Aluminium in Sonderfarbe lackiert RAL/NCS	Porte coulissante: aluminium couleur spéciale RAL/NCS

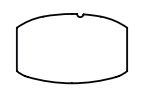
Finish, material & colour	Verpackungsmasse Dimensions de l'emballage Package dimensions	Gewicht Poids Weight	CHF	EUR
<p>Base unit: engineered wood, black Base: engineered wood, black, with black plastic cable grommet (centre back) d= 7 / 5.5 cm Back wall / sides: engineered wood black Top cover: clear glass, black-lacquered underside Feet: steel, powder-coated jetblack, Foot height: 30 cm Interior: 1x shelf, height adjustable (in 9.6 cm increments) with cable grommet (rounded recess in the middle)</p>	<p>→ 95 cm ↗ 60 cm ↑ 98 cm</p>			
Tambour door: aluminium, champagne anodized		53 kg	3199.-	3049.-
<p>Base unit: engineered wood, black Base: engineered wood, black, with black plastic cable grommet (centre back) d= 7 / 5.5 cm Back wall / sides: engineered wood black Top cover: clear glass, black-lacquered underside Feet: steel, powder-coated jetblack, Foot height: 30 cm Interior: 1x shelf, height adjustable (in 9.6 cm increments) with cable grommet (rounded recess in the middle)</p>	<p>→ 95 cm ↗ 60 cm ↑ 98 cm</p>			
Tambour door: aluminium, custom RAL/NCS colour		53 kg	3849.-	3669.-

Bestell-Nr. N° de commande Reference no.	Zubehör	Accessoires
	Mehrpreis für Kabeldurchführung in Glasabdeckplatte Durchmesser: 5.5 cm Positionierung: hinten mittig/rechts	Supplément pour le passage de câbles dans le plateau en verre Diamètre: 5.5 cm Positionnement: centré/à droite à l'arrière
84-012-571		
	Mehrpreis für Glasabdeckplatte farbig unterlackiert RAL/NCS	Supplément de prix pour le plateau en verre au dessous laqué de couleur RAL/NCS
84-030-400		
Ersatzteile		Pièces de rechange
	Ersatzablar, Farbe: Holzwerkstoff schwarz beschichtet Grösse: 69 x 45.7 cm h= 1.9 cm Kabeldurchlass: gerundete Aussparung (hinten) Tablarträger: höhenverstellbar (Raster: 4.5 cm)	Étagère de remplacement, couleur: bois composite revêtu de noir, dimensions: 69 x 45.7 cm h= 1.9 cm Passage de câbles: arrondi (à l'arrière) Support d'étagère: réglable en hauteur (pas: 4.5 cm)
84-010-321		
	Ersatzglasabdeckplatte, Farbe: Klarglas schwarz unterlackiert	Plateau de verre de rechange Couleur: verre transparent au dessous laqué noir
82-030-571		

Accessories	Verpackungsmasse Dimensions de l'emballage Package dimensions	Gewicht Poids Weight	CHF	EUR
Surcharge for cable grommet in glass cover plate Diameter: 5.5 cm Positioning: back centre/right			99.-	99.-
Surcharge for glass cover plate with underside lacquered in RAL/NCS colour			549.-	529.-
Spare parts				
Replacement shelf, Colour: Engineered wood, black Dimensions: 69 x 45.7 cm h= 1.9 cm Cable hole: round opening (back) Shelf supports: height adjustable (in 4.5 cm increments)			119.-	119.-
Replacement glass cover Colour: clear glass, black-lacquered underside			379.-	369.-



Shelf tower

Design:
Christophe Marchand
2001

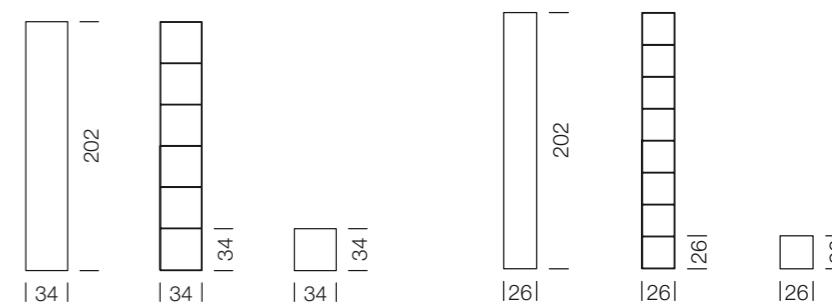

Masse in cm
Dimensions en cm
Dimensions in cm



Bestell-Nr. N° de commande Reference no.	Ausführung, Farbe & Material	Finition, matériau & couleur
	Regalteile: HPL weiss, Kante schwarz Rückwand: Acryl opalweiss inkl. Bodenplatte Stahl jetblack 33 x 33 cm Tragkraft pro Boden: 10 kg	Étagère: HPL blanc, chant noir Panneau arrière: acrylique blanc opalin base acier jetblack 33 x 33 cm comprise Capacité de charge par étagère: 10 kg
25-001-299		
	Regalteile: HPL weiss, Kante schwarz Rückwand: Acryl opalweiss inkl. Bodenplatte Stahl jetblack 25 x 25 cm Tragkraft pro Boden: 7 kg	Étagère: HPL blanc, chant noir Panneau arrière: acrylique blanc opalin base acier jetblack 25 x 25 cm comprise Capacité de charge par étagère: 7 kg
25-004-299		

Finish, material & colour	Verpackungsmasse Dimensions de l'emballage Package dimensions	Gewicht Poids Weight	CHF	EUR
Shelf: HPL, white; border, black Back wall: acrylic, opal white incl. steel base, jetblack 33 x 33 cm Load capacity per shelf: 10 kg	→ 38 cm ↗ 38 cm ↑ 206 cm			
		21 kg	1699.-	1619.-
Shelf: HPL, white; border, black Back wall: acrylic, opal white incl. steel base, jetblack 33 x 33 cm Load capacity per shelf: 10 kg	→ 30 cm ↗ 30 cm ↑ 206 cm			
		16 kg	1599.-	1529.-

Preise: UVP exkl. MwSt.
Prix: prix de vente
conseillés hors TVA
Prices: RRP ex. VAT

Shelf box

Design:
Christophe Marchand
2010 / 2011



Masse in cm
Dimensions en cm
Dimensions in cm

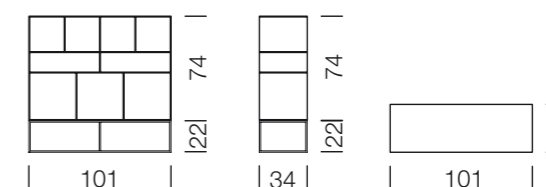

Bestell-Nr. N° de commande Reference no.	Ausführung, Farbe & Material	Finition, matériau & couleur
	drei Fächer 34 cm, zwei Fächer 15 cm, vier Fächer 26 cm Regalteile: HPL weiss, Kante schwarz Rückwand: Acryl opalweiss Untergestell: Metall jetblack	3 compartiments 34 cm, 2 compartiments 15 cm, 4 compartiments 26 cm Étagère: HPL blanc, chant noir Panneau arrière: acrylique blanc opalin Piètement: métal jetblack
52-001-299-451		

	drei Fächer 34 cm, zwei Fächer 15 cm, vier Fächer 26 cm), Regalteile: HPL weiss, Kante schwarz, Rückwand: Acryl opalweiss	3 compartiments 34 cm, 2 compartiments 15 cm, 4 compartiments 26 cm Étagère: HPL blanc, chant noir Panneau arrière: acrylique blanc opalin
52-001-299		

Finish, material & colour	Verpackungsmasse Dimensions de l'emballage Package dimensions	Gewicht Poids Weight	CHF	EUR
3 compartments 34 cm, 2 compartments 15 cm, 4 compartments 26 cm Shelf: HPL, white; border, black Back wall: acrylic, opal white Base frame: metal, jetblack	→ 101.5 cm ↑ 74 cm ↗ 34 cm → 103 cm ↑ 36 cm ↗ 24 cm			
		24 kg	2699.-	2579.-
3 compartments 34 cm, 2 compartments 15 cm, 4 compartments 26 cm Shelf: HPL, white; border, black Back wall: acrylic, opal white	→ 101.5 cm ↑ 74 cm ↗ 34 cm			
		17 kg	1799.-	1719.-

Preise: UVP exkl. MwSt.
Prix: prix de vente
conseillés hors TVA
Prices: RRP ex. VAT

Bestell-Nr. N° de commande Reference no.	Zubehör	Accessoires
	Untergestell Grösse: 101 x 34 cm h= 22 cm Farbe: Metall jetblack	Piètement Dimensions: 101 x 34 cm h= 22 cm Couleur: métal jetblack
52-021-451		

Accessories	Verpackungsmasse Dimensions de l'emballage Package dimensions	Gewicht Poids Weight	CHF	EUR
Base frame Dimensions: 101 x 34 cm h= 22 cm Colour: metal, jetblack	→ 103 cm ↗ 36 cm ↑ 24 cm			
		7 kg	989.-	949.-



Shelf system H2

Design:
Matthieu Girel
2019

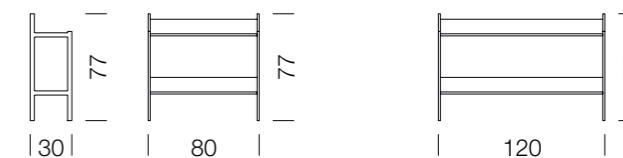

Masse in cm
Dimensions en cm
Dimensions in cm



Bestell-Nr. N° de commande Reference no.	Ausführung, Farbe & Material	Finition, matériau & couleur
	Regal H2-800 Farbe: Metall jetblack Bestehend aus: 2 x Seite H2 2 x Tablar L80	Étagère H2-800 Couleur: métal jetblack Composé de: 2 éléments latéraux H2 2 plateaux L80
70-001-451		
	Regal H2-1200 Farbe: Metall jetblack Bestehend aus: 2 x Seite H2 2 x Tablar L120	Étagère H2-1200 Couleur: métal jetblack Composé de: 2 éléments latéraux H2 2 plateaux L120
70-002-451		

Finish, material & colour	Verpackungsmasse Dimensions de l'emballage Package dimensions	Gewicht Poids Weight	CHF	EUR
Shelf H2-800 Colour: metal, jetblack Consisting of: 2x side panels H2 2x shelves L80				
			859.-	819.-
Shelf H2-1200 Colour: metal, jetblack Consisting of: 2x side panels H2 2x shelves L120				
			959.-	919.-

Preise: UVP exkl. MwSt.
Prix: prix de vente
conseillés hors TVA
Prices: RRP ex. VAT

Bestell-Nr. N° de commande Reference no.	Ausführung, Farbe & Material	Finition, matériau & couleur
	Anbau-Regal H2-800 Farbe: Metall jetblack Bestehend aus: 1 x Seite H2 2 x Tablar L80 1 x Set Verbindungsschrauben	Étagère extension H2-800 Couleur: métal jetblack Composé de: 1 élément latéral H2 2 étagères L80 1 kit de vis d'assemblage
70-101-451		

	Anbau-Regal H2-1200 Farbe: Metall jetblack Bestehend aus: 1 x Seite H2 2 x Tablar L120 1 x Set Verbindungsschrauben	Étagère extension H2-1200 Couleur: métal jetblack Composé de: 1 élément latéral H2 2 étagères L120 1 kit de vis d'assemblage
70-102-451		

Finish, material & colour	Verpackungsmasse Dimensions de l'emballage Package dimensions	Gewicht Poids Weight	CHF	EUR
Extra shelf H2-800 Colour: metal, jetblack Consisting of: 1x side panel H2 2x shelves L80 1x set of connecting screws			669.-	639.-
Extra shelf H2-1200 Colour: metal, jetblack Consisting of: 1x side panel H2 2x shelves L120 1x set of connecting screws			769.-	739.-



Shelf system H4

Design:
Matthieu Girel
2019

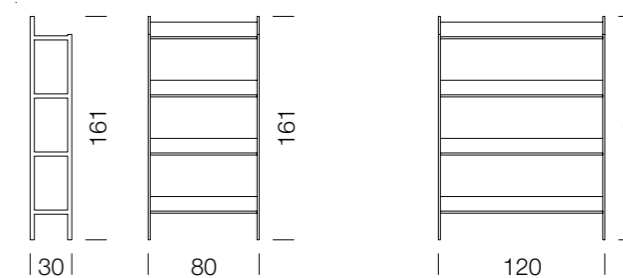

Masse in cm
Dimensions en cm
Dimensions in cm



Bestell-Nr. N° de commande Reference no.	Ausführung, Farbe & Material	Finition, matériau & couleur
	Regal H4-800 Farbe: Metall jetblack Bestehend aus: 2 x Seite H4 4 x Tablar L80	Étagère H4-800 Couleur: métal jetblack Composé de: 2 éléments latéraux H4 4 étagères L80
70-003-451		
	Regal H4-1200 Farbe: Metall jetblack Bestehend aus: 2 x Seite H4 4 x Tablar L120	Étagère H4-1200 Couleur: métal jetblack Composé de: 2 éléments latéraux H4 4 étagères L120
70-004-451		

Finish, material & colour	Verpackungsmasse Dimensions de l'emballage Package dimensions	Gewicht Poids Weight	CHF	EUR
Shelf H2-800 Colour: metal, jetblack Consisting of: 2x side panel H4 4x shelf L80			1639.-	1559.-
Shelf H2-1200 Colour: metal, jetblack Consisting of: 2x side panel H4 4x shelf L120			1839.-	1749.-

Preise: UVP exkl. MwSt.
Prix: prix de vente
conseillés hors TVA
Prices: RRP ex. VAT

Bestell-Nr. N° de commande Reference no.	Ausführung, Farbe & Material	Finition, matériau & couleur
	Anbau-Regal H4-800 Farbe: Metall jetblack Bestehend aus: 1 x Seite H4 4 x Tablar L80 2 x Set Verbindungsschrauben	Étagère extension H4-800 Couleur: métal jetblack Composé de: 1 élément latéral H4 4 étagères L80 1 kit de vis d'assemblage
70-103-451		

	Anbau-Regal H4-1200 Farbe: Metall jetblack Bestehend aus: 1 x Seite H4 4 x Tablar L120 2 x Set Verbindungsschrauben	Étagère extension H4-1200 Couleur: métal jetblack Composé de: 1 élément latéral H4 4 étagères L120 1 kit de vis d'assemblage
70-104-451		

Finish, material & colour	Verpackungsmasse Dimensions de l'emballage Package dimensions	Gewicht Poids Weight	CHF	EUR
Extra shelf H4-800 Colour: metal, jetblack Consisting of: 1x side panel H4 4x shelf L80 1x set of connecting screws				
			1299.-	1239.-
Extra shelf H4-1200 Colour: metal, jetblack Consisting of: 1x side panel H4 4x shelf L120 1x set of connecting screws				
			1499.-	1429.-

Bestell-Nr. N° de commande Reference no.	Ersatzteile	Pièces de rechange
	Seite H2 Grösse: 30 x 1.5 cm h= 77 cm Farbe: Metall jetblack	Élément latéral H2 Dimensions: 30 x 1.5 cm h= 77 cm Couleur: métal jetblack
70-011-451		
	Seite H4 Grösse: 30 x 1.5 cm h= 161 cm Farbe: Metall jetblack	Élément latéral H4 Dimensions: 30 x 1.5 cm h= 161 cm Couleur: métal jetblack
70-012-451		
	Tablar L80 Grösse: 80 x 30 cm h=13.5 cm Farbe: Metall jetblack inklusive 2 Beschläge und Verbindungsstangen	Étagère L80 Dimensions: 80 x 30 cm h=13.5 cm Couleur: métal jetblack Avec fixations et barres de liaison (2 pièces)
70-021-451		
	Tablar L120 Grösse: 120 x 30 cm h=13.5 cm Farbe: Metall jetblack inklusive 2 Beschläge und Verbindungsstangen	Étagère L120 Dimensions: 120 x 30 cm h=13.5 cm Couleur: métal jetblack Avec fixations et barres de liaison (2 pièces)
70-022-451		
	Verbindungsschraubenset 4 Stück für 2 Tablare Farbe: Metall jetblack	Set de vis d'assemblage 4 pièces pour 2 étagères Couleur: métal jetblack
70-030-451		

Spare parts	Verpackungsmasse Dimensions de l'emballage Package dimensions	Gewicht Poids Weight	CHF	EUR
Side panel H2 Dimensions: 30 x 1.5 cm h= 77 cm Colour: metal, jetblack	→ 2.5 cm ↗ 36 cm ↑ 77 cm			
		7 kg	189.-	189.-
Side panel H4 Dimensions: 30 x 1.5 cm h= 161 cm Colour: metal, jetblack	→ 2.5 cm ↗ 36 cm ↑ 161 cm			
		7 kg	339.-	329.-
Shelf L80 Dimensions: 80 x 30 cm h=13.5 cm Colour: metal, jetblack incl. fittings and connecting bars (2 pieces)	→ 79 cm ↗ 35 cm ↑ 16.5 cm			
		15 kg	239.-	229.-
Shelf L120 Dimensions: 120 x 30 cm h=13.5 cm Colour: metal, jetblack inkl. fittings and connecting bars (2 pieces)	→ 119 cm ↗ 35 cm ↑ 16.5 cm			
		22 kg	289.-	279.-
Fittings set 4 pieces for 2 shelves Colour: metal, jetblack				
			9.-	9.-

Table

Design:
Alfredo Häberli
2006



Masse in cm
Dimensions en cm
Dimensions in cm



Bestell-Nr. N° de commande Reference no.	Ausführung, Farbe & Material	Finition, matériau & couleur
	Tischgestell: Eiche massiv, natur lackiert Tischplatte: Eiche furniert, natur lackiert Tischplattenstärke: 4.5 cm	Pieds: chêne massif, verni naturel Plateau de table: chêne plaqué, verni naturel Épaisseur du plateau: 4.5 cm
38-161-171-071	Masse: 160 x 80 cm h= 74 cm	Dimensions: 160 x 80 cm h= 74 cm
38-202-171-071	Masse: 200 x 90 cm h= 74 cm	Dimensions: 200 x 90 cm h= 74 cm
38-222-171-071	Masse: 220 x 90 cm h= 74 cm	Dimensions: 220 x 90 cm h= 74 cm
38-243-171-071	Masse: 240 x 100 cm h= 74 cm	Dimensions: 240 x 100 cm h= 74 cm
38-263-171-071	Masse: 260 x 100 cm h= 74 cm	Dimensions: 260 x 100 cm h= 74 cm
38-283-171-071	Masse: 280 x 100 cm h= 74 cm	Dimensions: 280 x 100 cm h= 74 cm
38-304-171-071	Masse: 300 x 110 cm h= 74 cm	Dimensions: 300 x 110 cm h= 74 cm
38-325-171-071	Masse: 320 x 120 cm h= 74 cm	Dimensions: 320 x 120 cm h= 74 cm

Finish, material & colour	Verpackungsmasse Dimensions de l'emballage Package dimensions	Gewicht Poids Weight	CHF	EUR
Table legs: solid oak wood, natural lacquered Table top: oak veneer, natural lacquered Thickness of table top: 4.5 cm				
Dimensions: 160 x 80 cm h= 74 cm		55 kg	4999.-	4769.-
Dimensions: 200 x 90 cm h= 74 cm		60 kg	5299.-	5049.-
Dimensions: 220 x 90 cm h= 74 cm		63 kg	5599.-	5339.-
Dimensions: 240 x 100 cm h= 74 cm		70 kg	5999.-	5719.-
Dimensions: 260 x 100 cm h= 74 cm		77 kg	6099.-	5809.-
Dimensions: 280 x 100 cm h= 74 cm		75 kg	7099.-	6769.-
Dimensions: 300 x 110 cm h= 74 cm		92 kg	7699.-	7339.-
Dimensions: 320 x 120 cm h= 74 cm		95 kg	7999.-	7619.-

Preise: UVP exkl. MwSt.
Prix: prix de vente
conseillés hors TVA
Prices: RRP ex. VAT

Bestell-Nr. N° de commande Reference no.	Ausführung, Farbe & Material	Finition, matériau & couleur
	Tischgestell: Nussbaum massiv, natur lackiert Tischplatte: Nussbaum furniert, natur lackiert Tischplattenstärke: 4.5 cm	Pieds: noyer massif, verni naturel Plateau de table: noyer plaqué, verni naturel Épaisseur du plateau: 4.5 cm
38-161-181-081	Masse: 160 x 80 cm h= 74 cm	Dimensions: 160 x 80 cm h= 74 cm
38-202-181-081	Masse: 200 x 90 cm h= 74 cm	Dimensions: 200 x 90 cm h= 74 cm
38-222-181-081	Masse: 220 x 90 cm h= 74 cm	Dimensions: 220 x 90 cm h= 74 cm
38-243-181-081	Masse: 240 x 100 cm h= 74 cm	Dimensions: 240 x 100 cm h= 74 cm
38-263-181-081	Masse: 260 x 100 cm h= 74 cm	Dimensions: 260 x 100 cm h= 74 cm
38-283-181-081	Masse: 280 x 100 cm h= 74 cm	Dimensions: 280 x 100 cm h= 74 cm
38-304-181-081	Masse: 300 x 110 cm h= 74 cm	Dimensions: 300 x 110 cm h= 74 cm
38-325-181-081	Masse: 320 x 120 cm h= 74 cm	Dimensions: 320 x 120 cm h= 74 cm



	Tischgestell: Esche massiv, schwarz lackiert Tischplatte: Esche furniert, schwarz lackiert Tischplattenstärke: 4.5 cm	Pieds: frêne massif, verni noir Plateau de table: frêne plaqué, verni noir Épaisseur du plateau: 4.5 cm
38-161-191-091	Masse: 160 x 80 cm h= 74 cm	Dimensions: 160 x 80 cm h= 74 cm
38-202-191-091	Masse: 200 x 90 cm h= 74 cm	Dimensions: 200 x 90 cm h= 74 cm
38-222-191-091	Masse: 220 x 90 cm h= 74 cm	Dimensions: 220 x 90 cm h= 74 cm
38-223-191-091	Masse: 240 x 100 cm h= 74 cm	Dimensions: 240 x 100 cm h= 74 cm
38-243-191-091	Masse: 260 x 100 cm h= 74 cm	Dimensions: 260 x 100 cm h= 74 cm
38-262-181-081	Masse: 280 x 100 cm h= 74 cm	Dimensions: 280 x 100 cm h= 74 cm
38-283-191-091	Masse: 300 x 110 cm h= 74 cm	Dimensions: 300 x 110 cm h= 74 cm
38-304-191-091	Masse: 320 x 120 cm h= 74 cm	Dimensions: 320 x 120 cm h= 74 cm

Finish, material & colour	Verpackungsmasse Dimensions de l'emballage Package dimensions	Gewicht Poids Weight	CHF	EUR
Table legs: solid walnut wood, natural lacquered Table top: walnut veneer, natural lacquered Thickness of table top: 4.5 cm				
Dimensions: 160 x 80 cm h= 74 cm		55 kg	5599.-	5339.-
Dimensions: 200 x 90 cm h= 74 cm		60 kg	5999.-	5719.-
Dimensions: 220 x 90 cm h= 74 cm		63 kg	6199.-	5909.-
Dimensions: 240 x 100 cm h= 74 cm		70 kg	6599.-	6289.-
Dimensions: 260 x 100 cm h= 74 cm		77 kg	6799.-	6479.-
Dimensions: 280 x 100 cm h= 74 cm		75 kg	7799.-	7429.-
Dimensions: 300 x 110 cm h= 74 cm		92 kg	8499.-	8099.-
Dimensions: 320 x 120 cm h= 74 cm		95 kg	8799.-	8389.-
Table legs: solid ash wood, black lacquered Table top: ash veneer, black lacquered Thickness of table top: 4.5 cm				
Dimensions: 160 x 80 cm h= 74 cm		55 kg	4999.-	4769.-
Dimensions: 200 x 90 cm h= 74 cm		60 kg	5299.-	5049.-
Dimensions: 220 x 90 cm h= 74 cm		63 kg	5599.-	5339.-
Dimensions: 240 x 100 cm h= 74 cm		70 kg	5799.-	5529.-
Dimensions: 260 x 100 cm h= 74 cm		77 kg	5999.-	5719.-
Dimensions: 280 x 100 cm h= 74 cm		75 kg	6099.-	5809.-
Dimensions: 300 x 110 cm h= 74 cm		92 kg	7099.-	6769.-
Dimensions: 320 x 120 cm h= 74 cm		95 kg	7699.-	7339.-

Preise: UVP exkl. MwSt.
Prix: prix de vente
conseillés hors TVA
Prices: RRP ex. VAT

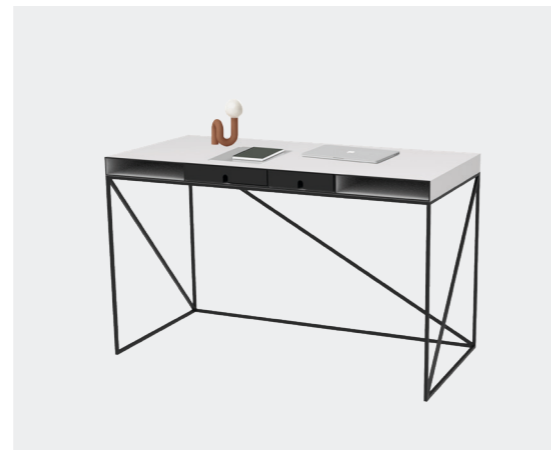

Desk small

Design:
Christophe Marchand
2012

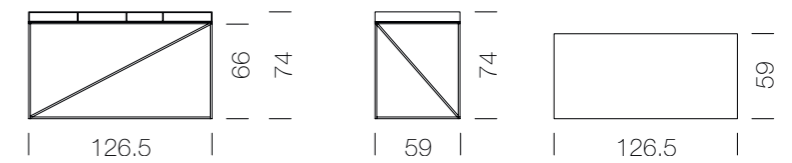

Masse in cm
Dimensions en cm
Dimensions in cm



Bestell-Nr. N° de commande Reference no.	Ausführung, Farbe & Material	Finition, matériau & couleur
	Untergestell: Metall jetblack Tischplatte: HPL weiss, Kante schwarz Kabeldurchlass: in der Rückwand (hinten links)	Piètement: métal jetblack Plateau de table: HPL blanc, chant noir Passage des câbles: dans le panneau arrière (arrière gauche)
54-002-451-299		
	Untergestell: Metall jetblack Tischplatte: HPL weiss, Kante schwarz Kabeldurchlass: in der Rückwand (hinten links) Innenausstattung: 1 x Einschubbox breit 1 x Einschubbox schmal	Piètement: métal jetblack Plateau de table: HPL blanc, chant noir Passage des câbles: dans le panneau arrière (arrière gauche) Aménagement intérieur: 1 grande boîte coulissante 1 petite boîte coulissante
54-102-451-299		

Finish, material & colour	Verpackungsmasse Dimensions de l'emballage Package dimensions	Gewicht Poids Weight	CHF	EUR
Base frame: metal, jetblack Table top: HPL, white; border, black Cable grommet: in the back wall (back left)	→ 132 cm ↗ 65 cm ↑ 80 cm			
		28 kg	3299.-	3149.-
Base frame: metal, jetblack Table top: HPL, white; border, black Cable grommet: in the back wall (back left) Interior: 1x sliding box, large 1x sliding box, small	→ 132 cm ↗ 65 cm ↑ 80 cm			
		28 kg	3499.-	3339.-

Preise: UVP exkl. MwSt.
Prix: prix de vente
conseillés hors TVA
Prices: RRP ex. VAT

Desk big

Design:
Christophe Marchand
2012



Masse in cm
Dimensions en cm
Dimensions in cm

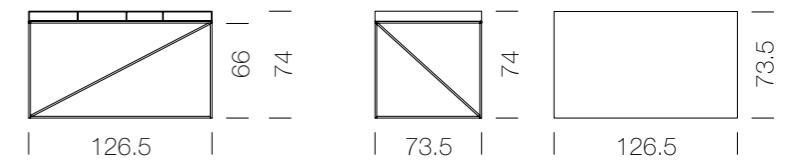

Bestell-Nr. N° de commande Reference no.	Ausführung, Farbe & Material	Finition, matériau & couleur
	Untergestell: Metall jetblack Tischplatte: HPL weiss, Kante schwarz Hohlraum für Kabel (von unten zugänglich)	Piètement: métal jetblack Plateau de table: HPL blanc, chant noir Cavité pour les câbles (accessible par le bas)
54-003-451-299		

	Untergestell: Metall jetblack Tischplatte: HPL weiss, Kante schwarz Hohlraum für Kabel (von unten zugänglich) Innenausstattung: 1 x Einschubbox breit 1 x Einschubbox schmal	Piètement: métal jetblack Plateau de table: HPL blanc, chant noir Cavité pour les câbles (accessible par le bas) Aménagement intérieur: 1 grande boîte coulissante 1 petite boîte coulissante
54-103-451-299		

Finish, material & colour	Verpackungsmasse Dimensions de l'emballage Package dimensions	Gewicht Poids Weight	CHF	EUR
Base frame: metal, jetblack Table top: HPL, white; border, black Cavity for cables (accessible from below)	→ 132 cm ↗ 80 cm ↑ 80 cm			
		33 kg	3399.-	3239.-
Base frame: metal, jetblack Table top: HPL, white; border, black Cavity for cables (accessible from below) Interior: 1x sliding box, large 1x sliding box, small	→ 132 cm ↗ 80 cm ↑ 80 cm			
		33 kg	3599.-	3429.-

Preise: UVP exkl. MwSt.
Prix: prix de vente
conseillés hors TVA
Prices: RRP ex. VAT

Bestell-Nr. N° de commande Reference no.	Zubehör	Accessoires
	Einschubbox breit Grösse: 32.9 x 33.4 cm h= 5.7 cm Farbe: Metall jetblack	Grande boîte coulissante Dimensions: 32.9 x 33.4 cm h= 5.7 cm Couleur: métal jetblack
54-011-451		
	Einschubbox schmal Grösse: 24.5 x 33.4 cm h= 5.7 cm Farbe: Metall jetblack	Petite boîte coulissante Dimensions: 24.5 x 33.4 cm h= 5.7 cm Couleur: métal jetblack
54-021-451		

Accessories	Verpackungsmasse Dimensions de l'emballage Package dimensions	Gewicht Poids Weight	CHF	EUR
Sliding box, large Dimensions: 32.9 x 33.4 cm h= 5.7 cm Colour: metal, jetblack	→ 35 cm ↗ 35 cm ↑ 7 cm	1.5 kg	119.-	119.-
Sliding box, small Dimensions: 24.5 x 33.4 cm h= 5.7 cm Colour: metal, jetblack	→ 26.5 cm ↑ 36.4 cm ↗ 7.7 cm	1.5 kg	99.-	99.-

Lounger textile

Design:
Christophe Marchand
2002 / 2019



Masse in cm
Dimensions en cm
Dimensions in cm

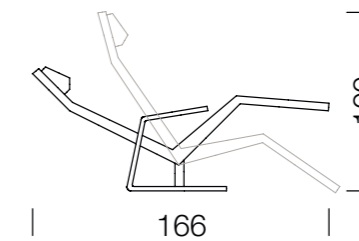



Bestell-Nr. N° de commande Reference no.	Ausführung, Farbe & Material	Finition, matériau & couleur
	Bezug: Stoff Rye weiss-grau 650 51% PES / 38% PC / 9% CO / 2% PA Kopfstütze: magnetisch stufenlos verstellbar	Revêtement: tissu Rye blanc-gris 650 51% PES / 38% PC / 9% CO / 2% PA Appui-tête: réglable magnétiquement en continu
72-001-465-650	Gestell: Metall sepia dunkel	Piètement: métal sépia foncé
72-001-803-650	Gestell: Metall verchromt	Piètement: métal chromé

	Bezug: Stoff Rye dunkelgrau 651 51% PES / 38% PC / 9% CO / 2% PA Kopfstütze: magnetisch stufenlos verstellbar	Revêtement: tissu Rye gris foncé 651 51% PES / 38% PC / 9% CO / 2% PA Appui-tête: réglable magnétiquement en continu
72-001-465-651	Gestell: Metall sepia dunkel	Piètement: métal sépia foncé
72-001-803-651	Gestell: Metall verchromt	Piètement: métal chromé

Finish, material & colour	Verpackungsmasse Dimensions de l'emballage Package dimensions	Gewicht Poids Weight	CHF	EUR
Upholstery: Rye fabric, white-grey 650 51% PES / 38% PC / 9% CO / 2% PA Headrest: magnetically infinitely adjustable	→ 158 cm ↗ 63 cm ↑ 111 cm			
Frame: metal, dark sepia		34 kg	4749.-	4529.-
Frame: metal, chromed		34 kg	5149.-	4909.-
Upholstery: Rye fabric, dark grey 651 51% PES / 38% PC / 9% CO / 2% PA Headrest: magnetically infinitely adjustable	→ 158 cm ↗ 63 cm ↑ 111 cm			
Frame: metal, dark sepia		34 kg	4749.-	4529.-
Frame: metal, chromed		34 kg	5149.-	4909.-

Preise: UVP exkl. MwSt.
Prix: prix de vente
conseillés hors TVA
Prices: RRP ex. VAT

Bestell-Nr. N° de commande Reference no.	Ausführung, Farbe & Material	Finition, matériau & couleur
	Bezug: Stoff Rye hellgrau 652 51% PES / 38% PC / 9% CO / 2% PA Kopfstütze: magnetisch stufenlos verstellbar	Revêtement: tissu Rye gris clair 652 51% PES / 38% PC / 9% CO / 2% PA Appui-tête: réglable magnétiquement en continu
72-001-465-652	Gestell: Metall sepia dunkel	Piètement: métal sépia foncé
72-001-803-652	Gestell: Metall verchromt	Piètement: métal chromé

	Bezug: Stoff Topia platin 660 95% WV / 5% PA Kopfstütze: magnetisch stufenlos verstellbar	Revêtement: tissu Topia platine 660 95% WV / 5% PA Appui-tête: réglable magnétiquement en continu
72-001-465-660	Gestell: Metall sepia dunkel	Piètement: métal sépia foncé
72-001-803-660	Gestell: Metall verchromt	Piètement: métal chromé

	Bezug: Stoff Credo pepper 661 95% WV / 5% PA Kopfstütze: magnetisch stufenlos verstellbar	Revêtement: tissu Credo pepper 661 95% WV / 5% PA Appui-tête: réglable magnétiquement en continu
72-001-465-661	Gestell: Metall sepia dunkel	Piètement: métal sépia foncé
72-001-803-661	Gestell: Metall verchromt	Piètement: métal chromé

Finish, material & colour	Verpackungsmasse Dimensions de l'emballage Package dimensions	Gewicht Poids Weight	CHF	EUR
Upholstery: Rye fabric, light grey 652 51% PES / 38% PC / 9% CO / 2% PA Headrest: magnetically infinitely adjustable	→ 158 cm ↗ 63 cm ↑ 111 cm			
Frame: metal, dark sepia		34 kg	4749.-	4529.-
Frame: metal, chromed		34 kg	5149.-	4909.-
Upholstery: Topia fabric, platinum 660 95% WV / 5% PA Headrest: magnetically infinitely adjustable	→ 158 cm ↗ 63 cm ↑ 111 cm			
Frame: metal, dark sepia		34 kg	4849.-	4619.-
Frame: metal, chromed		34 kg	5249.-	4999.-
Upholstery: Credo fabric, pepper 661 95% WV / 5% PA Headrest: magnetically infinitely adjustable	→ 158 cm ↗ 63 cm ↑ 111 cm			
Frame: metal, dark sepia		34 kg	4899.-	4669.-
Frame: metal, chromed		34 kg	5299.-	5049.-

Preise: UVP exkl. MwSt.
Prix: prix de vente
conseillés hors TVA
Prices: RRP ex. VAT

Bestell-Nr. N° de commande Reference no.	Ausführung, Farbe & Material	Finition, matériau & couleur
	Bezug: Stoff Credo snow 662 95% WV / 5% PA Kopfstütze: magnetisch stufenlos verstellbar	Revêtement: tissu Credo snow 662 95% WV / 5% PA Appui-tête: réglable magnétiquement en continu
72-001-465-662	Gestell: Metall sepia dunkel	Piètement: métal sépia foncé
72-001-803-662	Gestell: Metall verchromt	Piètement: métal chromé

	Bezug: Stoff Topia ebony 663 95% WV / 5% PA Kopfstütze: magnetisch stufenlos verstellbar	Revêtement: tissu Topia ebony 663 95% WV / 5% PA Appui-tête: réglable magnétiquement en continu
72-001-465-663	Gestell: Metall sepia dunkel	Piètement: métal sépia foncé
72-001-803-663	Gestell: Metall verchromt	Piètement: métal chromé

	Bezug: Stoff Credo black 664 95% WV / 5% PA Kopfstütze: magnetisch stufenlos verstellbar	Revêtement: tissu Credo black 664 95% WV / 5% PA Appui-tête: réglable magnétiquement en continu
72-001-465-664	Gestell: Metall sepia dunkel	Piètement: métal sépia foncé
72-001-803-664	Gestell: Metall verchromt	Piètement: métal chromé

Finish, material & colour	Verpackungsmasse Dimensions de l'emballage Package dimensions	Gewicht Poids Weight	CHF	EUR
Upholstery: Credo fabric, snow 662 95% WV / 5% PA Headrest: magnetically infinitely adjustable	→ 158 cm ↗ 63 cm ↑ 111 cm			
Frame: metal, dark sepia		34 kg	4899.-	4669.-
Frame: metal, chromed		34 kg	5299.-	5049.-
Upholstery: Topia fabric, ebony 663 95% WV / 5% PA Headrest: magnetically infinitely adjustable	→ 158 cm ↗ 63 cm ↑ 111 cm			
Frame: metal, dark sepia		34 kg	4849.-	4619.-
Frame: metal, chromed		34 kg	5249.-	4999.-
Upholstery: Credo fabric, black 664 95% WV / 5% PA Headrest: magnetically infinitely adjustable	→ 158 cm ↗ 63 cm ↑ 111 cm			
Frame: metal, dark sepia		34 kg	4899.-	4669.-
Frame: metal, chromed		34 kg	5299.-	5049.-

Preise: UVP exkl. MwSt.
Prix: prix de vente
conseillés hors TVA
Prices: RRP ex. VAT

Bestell-Nr. N° de commande Reference no.	Ausführung, Farbe & Material	Finition, matériau & couleur
	Bezug: Stoff Lano blau-grau 670 85% WV / 15% PA Kopfstütze: magnetisch stufenlos verstellbar	Revêtement: tissu Lano bleu-gris 670 85% WV / 15% PA Appui-tête: réglable magnétiquement en continu
72-001-465-670	Gestell: Metall sepia dunkel	Piètement: métal sépia foncé
72-001-803-670	Gestell: Metall verchromt	Piètement: métal chromé

	Bezug: Stoff Bonus dunkelgrau 671 85% WV / 15% PA Kopfstütze: magnetisch stufenlos verstellbar	Revêtement: tissu Bonus gris foncé 671 85% WV / 15% PA Appui-tête: réglable magnétiquement en continu
72-001-465-671	Gestell: Metall sepia dunkel	Piètement: métal sépia foncé
72-001-803-671	Gestell: Metall verchromt	Piètement: métal chromé

	Bezug: Stoff Bonus hellgrau 672 85% WV / 15% PA Kopfstütze: magnetisch stufenlos verstellbar	Revêtement: tissu Bonus gris clair 672 85% WV / 15% PA Appui-tête: réglable magnétiquement en continu
72-001-465-672	Gestell: Metall sepia dunkel	Piètement: métal sépia foncé
72-001-803-672	Gestell: Metall verchromt	Piètement: métal chromé

Finish, material & colour	Verpackungsmasse Dimensions de l'emballage Package dimensions	Gewicht Poids Weight	CHF	EUR
Upholstery: Lano fabric, blue-grey 670 85% WV / 15% PA Headrest: magnetically infinitely adjustable	→ 158 cm ↗ 63 cm ↑ 111 cm			
Frame: metal, dark sepia		34 kg	4749.-	4529.-
Frame: metal, chromed		34 kg	5149.-	4909.-
Upholstery: Bonus fabric, dark grey 671 85% WV / 15% PA Headrest: magnetically infinitely adjustable	→ 158 cm ↗ 63 cm ↑ 111 cm			
Frame: metal, dark sepia		34 kg	4799.-	4579.-
Frame: metal, chromed		34 kg	5199.-	4959.-
Upholstery: Bonus fabric, light grey 672 85% WV / 15% PA Headrest: magnetically infinitely adjustable	→ 158 cm ↗ 63 cm ↑ 111 cm			
Frame: metal, dark sepia		34 kg	4799.-	4579.-
Frame: metal, chromed		34 kg	5199.-	4959.-

Preise: UVP exkl. MwSt.
Prix: prix de vente
conseillés hors TVA
Prices: RRP ex. VAT

Bestell-Nr. N° de commande Reference no.	Ausführung, Farbe & Material	Finition, matériau & couleur
	Bezug: Kundenwunsch Stoffbedarf: 3.1 lfm Kopfstütze: magnetisch stufenlos verstellbar	Revêtement: à la demande du client Tissu nécessaire: 3.1 mètres courants Appui-tête: réglable magnétiquement en continu
72-001-465-800-S	Gestell: Metall sepia dunkel	Piètement: métal sépia foncé
72-001-803-800-S	Gestell: Metall verchromt	Piètement: métal chromé

Finish, material & colour	Verpackungsmasse Dimensions de l'emballage Package dimensions	Gewicht Poids Weight	CHF	EUR
Upholstery: customer request Fabric required: 3.1 linear metres Headrest: magnetically infinitely adjustable	→ 158 cm ↗ 63 cm ↑ 111 cm			
Frame: metal, dark sepia		34 kg	4899.-	4669.-
Frame: metal, chromed		34 kg	5299.-	5049.-

Lounger leather

Design:
Christophe Marchand
2002 / 2019



Masse in cm
Dimensions en cm
Dimensions in cm

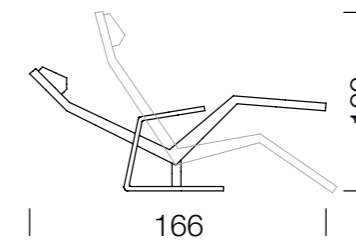



Bestell-Nr. N° de commande Reference no.	Ausführung, Farbe & Material	Finition, matériau & couleur
	Bezug: Leder midnight black 701 Kopfstütze: magnetisch stufenlos verstellbar	Revêtement: cuir midnight black 701 Appui-tête: réglable magnétiquement en continu
72-001-465-701	Gestell: Metall sepia dunkel	Piètement: métal sépia foncé
72-001-803-701	Gestell: Metall verchromt	Piètement: métal chromé

	Bezug: Leder platin grey 731 Kopfstütze: magnetisch stufenlos verstellbar	Revêtement: cuir platin grey 731 Appui-tête: réglable magnétiquement en continu
72-001-465-731	Gestell: Metall sepia dunkel	Piètement: métal sépia foncé
72-001-803-731	Gestell: Metall verchromt	Piètement: métal chromé

Finish, material & colour	Verpackungsmasse Dimensions de l'emballage Package dimensions	Gewicht Poids Weight	CHF	EUR
Upholstery: leather, midnight black 701 Headrest: magnetically infinitely adjustable	→ 158 cm ↗ 63 cm ↑ 111 cm			
Frame: metal, dark sepia		34 kg	5199.-	4959.-
Frame: metal, chromed		34 kg	5599.-	5339.-
Upholstery: leather, platinum grey 731 Headrest: magnetically infinitely adjustable	→ 158 cm ↗ 63 cm ↑ 111 cm			
Frame: metal, dark sepia		34 kg	5349.-	5099.-
Frame: metal, chromed		34 kg	5749.-	5479.-

Preise: UVP exkl. MwSt.
Prix: prix de vente
conseillés hors TVA
Prices: RRP ex. VAT

Bestell-Nr. N° de commande Reference no.	Ausführung, Farbe & Material	Finition, matériau & couleur
	Bezug: Leder asphalt grey 736 Kopfstütze: magnetisch stufenlos verstellbar	Revêtement: cuir asphalt grey 736 Appui-tête: réglable magnétiquement en continu
72-001-465-736	Gestell: Metall sepia dunkel	Piètement: métal sépia foncé
72-001-803-736	Gestell: Metall verchromt	Piètement: métal chromé

	Bezug: Leder signal red 741 Kopfstütze: magnetisch stufenlos verstellbar	Revêtement: cuir signal red 741 Appui-tête: réglable magnétiquement en continu
72-001-465-741	Gestell: Metall sepia dunkel	Piètement: métal sépia foncé
72-001-803-741	Gestell: Metall verchromt	Piètement: métal chromé

	Bezug: Leder cappuccino 750 Kopfstütze: magnetisch stufenlos verstellbar	Revêtement: cuir cappuccino 750 Appui-tête: réglable magnétiquement en continu
72-001-465-750	Gestell: Metall sepia dunkel	Piètement: métal sépia foncé
72-001-803-750	Gestell: Metall verchromt	Piètement: métal chromé

Finish, material & colour	Verpackungsmasse Dimensions de l'emballage Package dimensions	Gewicht Poids Weight	CHF	EUR
Upholstery: leather, asphalt grey 736 Headrest: magnetically infinitely adjustable	→ 158 cm ↗ 63 cm ↑ 111 cm			
Frame: metal, dark sepia		34 kg	5349.-	5099.-
Frame: metal, chromed		34 kg	5749.-	5479.-
Upholstery: leather, signal red 741 Headrest: magnetically infinitely adjustable	→ 158 cm ↗ 63 cm ↑ 111 cm			
Frame: metal, dark sepia		34 kg	5349.-	5099.-
Frame: metal, chromed		34 kg	5749.-	5479.-
Upholstery: leather, cappuccino 750 Headrest: magnetically infinitely adjustable	→ 158 cm ↗ 63 cm ↑ 111 cm			
Frame: metal, dark sepia		34 kg	5349.-	5099.-
Frame: metal, chromed		34 kg	5749.-	5479.-

Bestell-Nr. N° de commande Reference no.	Ausführung, Farbe & Material	Finition, matériau & couleur
	Bezug: Leder fango 752 Kopfstütze: magnetisch stufenlos verstellbar	Revêtement: cuir fango 752 Appui-tête: réglable magnétiquement en continu
72-001-465-752	Gestell: Metall sepia dunkel	Piètement: métal sépia foncé
72-001-803-752	Gestell: Metall verchromt	Piètement: métal chromé

	Bezug: Leder sand 753 Kopfstütze: magnetisch stufenlos verstellbar	Revêtement: cuir sand 753 Appui-tête: réglable magnétiquement en continu
72-001-465-753	Gestell: Metall sepia dunkel	Piètement: métal sépia foncé
72-001-803-753	Gestell: Metall verchromt	Piètement: métal chromé

	Bezug: Leder walnut 761 Kopfstütze: magnetisch stufenlos verstellbar	Revêtement: cuir walnut 761 Appui-tête: réglable magnétiquement en continu
72-001-465-761	Gestell: Metall sepia dunkel	Piètement: métal sépia foncé
72-001-803-761	Gestell: Metall verchromt	Piètement: métal chromé

Finish, material & colour	Verpackungsmasse Dimensions de l'emballage Package dimensions	Gewicht Poids Weight	CHF	EUR
Upholstery: leather, fango 752 Headrest: magnetically infinitely adjustable	→ 158 cm ↗ 63 cm ↑ 111 cm			
Frame: metal, dark sepia		34 kg	5349.-	5099.-
Frame: metal, chromed		34 kg	5749.-	5479.-
Upholstery: leather, sand 753 Headrest: magnetically infinitely adjustable	→ 158 cm ↗ 63 cm ↑ 111 cm			
Frame: metal, dark sepia		34 kg	5349.-	5099.-
Frame: metal, chromed		34 kg	5749.-	5479.-
Upholstery: leather, walnut 761 Headrest: magnetically infinitely adjustable	→ 158 cm ↗ 63 cm ↑ 111 cm			
Frame: metal, dark sepia		34 kg	5349.-	5099.-
Frame: metal, chromed		34 kg	5749.-	5479.-

Bestell-Nr. N° de commande Reference no.	Ausführung, Farbe & Material	Finition, matériau & couleur
	Bezug: Leder brown pepper 762 Kopfstütze: magnetisch stufenlos verstellbar	Revêtement: cuir brown pepper 762 Appui-tête: réglable magnétiquement en continu
72-001-465-762	Gestell: Metall sepia dunkel	Piètement: métal sépia foncé
72-001-803-762	Gestell: Metall verchromt	Piètement: métal chromé

	Bezug: Leder tabak brown 764 Kopfstütze: magnetisch stufenlos verstellbar	Revêtement: cuir tabak brown 764 Appui-tête: réglable magnétiquement en continu
72-001-465-764	Gestell: Metall sepia dunkel	Piètement: métal sépia foncé
72-001-803-764	Gestell: Metall verchromt	Piètement: métal chromé

	Bezug: Leder cashmere white 772 Kopfstütze: magnetisch stufenlos verstellbar	Revêtement: cuir cashmere white 772 Appui-tête: réglable magnétiquement en continu
72-001-465-772	Gestell: Metall sepia dunkel	Piètement: métal sépia foncé
72-001-803-772	Gestell: Metall verchromt	Piètement: métal chromé

Finish, material & colour	Verpackungsmasse Dimensions de l'emballage Package dimensions	Gewicht Poids Weight	CHF	EUR
Upholstery: leather, brown pepper 762 Headrest: magnetically infinitely adjustable	→ 158 cm ↗ 63 cm ↑ 111 cm			
Frame: metal, dark sepia		34 kg	5349.-	5099.-
Frame: metal, chromed		34 kg	5749.-	5479.-
Upholstery: leather, tabak brown 764 Headrest: magnetically infinitely adjustable	→ 158 cm ↗ 63 cm ↑ 111 cm			
Frame: metal, dark sepia		34 kg	5349.-	5099.-
Frame: metal, chromed		34 kg	5749.-	5479.-
Upholstery: leather, cashmere white 772 Headrest: magnetically infinitely adjustable	→ 158 cm ↗ 63 cm ↑ 111 cm			
Frame: metal, dark sepia		34 kg	5349.-	5099.-
Frame: metal, chromed		34 kg	5749.-	5479.-

Bestell-Nr. N° de commande Reference no.	Ausführung, Farbe & Material	Finition, matériau & couleur
	Bezug: Kundenwunsch Lederbedarf: 4.3 m2 vorherige Prüfung durch Produktion notwendig Kopfstütze: magnetisch stufenlos verstellbar	Revêtement: à la demande du client Cuir nécessaire: 4.3 m2 Nécessité d'une inspection préalable par la production Appui-tête: réglable magnétiquement en continu
72-001-465-800-L	Gestell: Metall sepia dunkel	Piètement: métal sépia foncé
72-001-803-800-L	Gestell: Metall verchromt	Piètement: métal chromé

Finish, material & colour	Verpackungsmasse Dimensions de l'emballage Package dimensions	Gewicht Poids Weight	CHF	EUR
Upholstery: customer request Leather required: 4.3 m2 Prior inspection by production department necessary Headrest: magnetically infinitely adjustable	→ 158 cm ↗ 63 cm ↑ 111 cm			
Frame: metal, dark sepia		34 kg	5199.-	4959.-
Frame: metal, chromed		34 kg	5599.-	5339.-

Farben & Materialien
Couleurs & matériaux
Colours & Materials



Klarglas Verre transparent Clear glass	Klarglas, weiss unterlackiert Verre transparent au dessous laqué blanc Clear glass, white-lacquered underside	Klarglas, schwarz unterlackiert Verre transparent au dessous laqué noir Clear glass, black-lacquered underside	Klarglas, farbig unterlackiert RAL/NCS Verre transparent au dessous laqué RAL/NCS Clear glass, lacquered underside in RAL/NCS
551	561	751	551/400
wogg 17 wogg 18 wogg 44 wogg 67 wogg 73	wogg 17 wogg 18 wogg 44 wogg 67 wogg 73 wogg 74	wogg 17 wogg 18 wogg 44 wogg 67 wogg 73 wogg 74 wogg 82 wogg 83 wogg 84	wogg 82 wogg 83 wogg 84

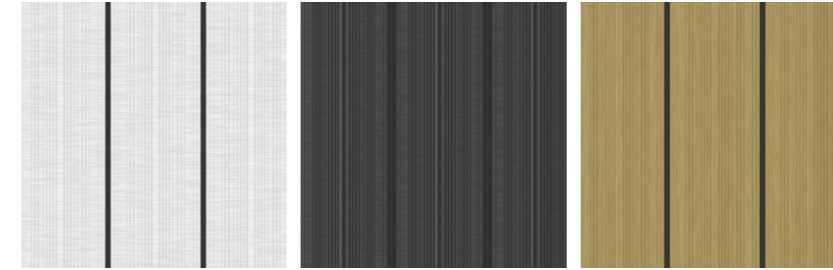

Aluminium, eloxiert natur Aluminium, anodisé naturel Aluminium, anodized natural	Aluminium, eloxiert schwarz Aluminium, anodisé noir Aluminium, anodized black	Aluminium eloxiert, champagner Aluminium anodisé, champagner Aluminium anodized, champagne
013	014	015
wogg 17 wogg 18 wogg 44 wogg 67 wogg 73 wogg 79 wogg 81 wogg 82 wogg 83 wogg 84	wogg 17 wogg 18 wogg 44 wogg 67 wogg 73 wogg 79 wogg 81 wogg 82 wogg 83 wogg 84	wogg 79 wogg 81 wogg 82 wogg 83 wogg 84



Eiche, natur Chêne, naturel Oak, natural	Eiche, weiss lackiert Chêne, laqué blanc Oak, white lacquered	Eiche, schwarz lackiert Chêne, laqué noir Oak, black lacquered	Kunststoff (PP), opal weiss Plastique (PP), blanc opalin Plastic (PP), opal white	Kunststoff (PP), schwarz Plastique (PP), noir Plastic (PP), black
075	076	077	056	071
wogg 67 wogg 73 wogg 74	wogg 67 wogg 73 wogg 74	wogg 67 wogg 73 wogg 74	wogg 17 wogg 18 wogg 44 wogg 73 wogg 74	wogg 17 wogg 18 wogg 44 wogg 73 wogg 74



Stahlblech lackiert, light grey Tôle d'acier laquée, light grey Lacquered sheet steel, light grey	Stahlblech lackiert, sky blue Tôle d'acier laquée, sky blue Lacquered sheet steel, sky blue	Stahlblech lackiert, olive Tôle d'acier laquée, olive Lacquered sheet steel, olive	Stahlblech lackiert, stonegray Tôle d'acier laquée, stonegray Lacquered sheet steel, stone gray	Stahlblech lackiert, morning tea Tôle d'acier laquée, morning tea Lacquered sheet steel, morning tea
NCS S-4000-N	NCS S1030-R90B	NCS S6020 -G70Y	NCS S 500 5-Y50R	NCS S 2005-R20B
468	467	466	454	459
wogg 13 wogg 80	wogg 13 wogg 80	wogg 13 wogg 80	wogg 13 wogg 80	wogg 13 wogg 80



Stahlblech lackiert, saffron Tôle d'acier laquée, saffron Lacquered sheet steel, saffron	Stahlblech lackiert, traffic white Tôle d'acier laquée, traffic white Lacquered sheet steel, traffic white	Stahlblech lackiert, jetblack Tôle d'acier laquée, jetblack Lacquered sheet steel, jetblack	Stahlblech lackiert, gold Tôle d'acier laquée, gold Lacquered sheet steel, gold
NCS S 356 0-R	RAL 9010	RAL 9005	041
462	453	451	wogg 13 wogg 80
wogg 13 wogg 80	wogg 13 wogg 80	wogg 13 wogg 80 wogg 70	



Eiche, natur lackiert Chêne, laqué naturel Oak, natural lacquered	Nussbaum, natur lackiert Noyer, laqué naturel Walnut, natural lacquered	Esche, schwarz lackiert Frêne, laqué noir Ash, black lacquered
171/071	181/081	191/091
wogg 38	wogg 38	wogg 38



Metall verchromt Métal chromé Metal, chromed	Metall sepia dunkel Métal sépia foncé Metal, dark sepia
803	RAL 8022
wogg 72	465 wogg 72

Farben & Materialien
Couleurs & matériaux
Colours & Materials

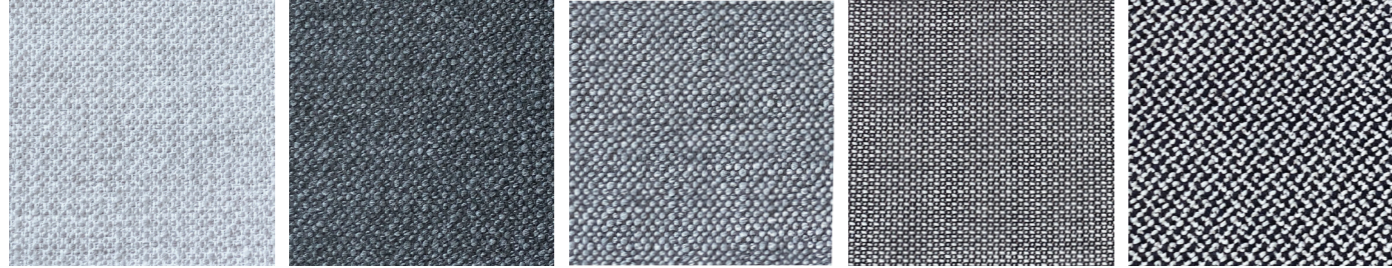

Stoff Rye weiss-grau
Tissu Rye blanc-gris
Rye fabric, white-grey

650

wogg72

Stoff Rye dunkelgrau
Tissu Rye gris foncé
Rye fabric, dark grey

651

wogg72

Stoff Rye hellgrau
Tissu Rye gris clair
Rye fabric, light grey

652

wogg72

Stoff Topia platin
Tissu Topia platine
Topia fabric, platinum

660

wogg72

Stoff Credo pepper
Tissu Credo pepper
Credo fabric, pepper

661

wogg72



Stoff Credo snow
Tissu Credo snow
Credo fabric, snow

662

wogg72

Stoff Topia ebony
Tissu Topia ebony
Topia fabric, ebony

663

wogg72

Stoff Credo black
Tissu Credo black
Credo fabric, black

664

wogg72

Stoff Lano blau-grau
Tissu Lano bleu-gris
Lano fabric, blue-grey

670

wogg72

Stoff Bonus dunkelgrau
Tissu Bonus gris foncé
Bonus fabric, dark grey

671

wogg72

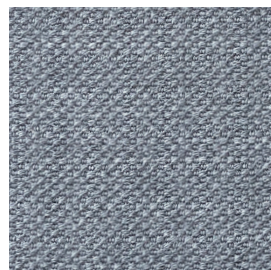

Stoff Bonus hellgrau
Tissu Bonus gris clair
Bonus fabric, light grey

672

wogg72

Farben & Materialien
Couleurs & matériaux
Colours & Materials



Leder midnight black
Cuir cuir midnight black
Leather, midnight black

701

wogg72

Leder platin grey
Cuir platin grey
Leather, platinum grey

731

wogg72

Leder asphalt grey
Cuir asphalt grey
Leather, asphalt grey

736

wogg72

Leder signal red
Cuir signal red
Leather, signal red

741

wogg72

Leder cappuccino
Cuir cappuccino
Leather, cappuccino

750

wogg72



Leder fango
Cuir fango
Leather, fango

752

wogg72

Leder sand
Cuir sand
Leather, sand

753

wogg72

Leder walnut
Cuir walnut
Leather, walnut

761

wogg72

Leder brown pepper
Cuir brown pepper
Leather, brown pepper

762

wogg72

Leder tabak brown
Cuir tabak brown
Leather, tabak brown

764

wogg72

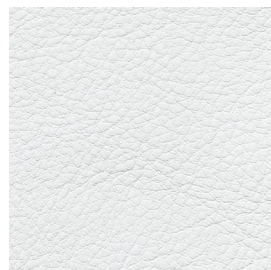

Leder cashmere white
Cuir cashmere white
Leather, cashmere white

772

wogg72

1. Geltungsbereich

Diese Allgemeinen Lieferbedingungen (ALB) gelten für alle Verträge über die Lieferung von Waren und sinngemäss auch für die Erbringung von Leistungen gegenüber unseren Kunden, soweit nicht schriftlich etwas anderes vereinbart wurde. Der Kunde nimmt durch seine Bestellung diese ALB vorbehaltlos an.

Diese ALB werden auch durch anderslautende Allgemeine Geschäftsbedingungen des Kunden nicht aufgehoben, es sei denn, dass Abweichungen beim Vertragsabschluss schriftlich ausdrücklich vereinbart worden sind.

2. Zustandekommen eines Vertrages

Die Bestellung des Kunden ist ein bindendes Angebot. Der Vertrag kommt mit unserer schriftlichen Auftragsbestätigung zustande. Die Auftragsbestätigungen sind nach Erhalt zu prüfen. Beanstandungen sind uns umgehend schriftlich mitzuteilen. Allfällige Angebote unsererseits erfolgen freibleibend.

Tritt der Kunde vom Vertrag zurück, bevor die Ware dem Frachtführer übergeben worden ist oder erfüllt der Kunde den Vertrag schuldhaft nicht, so schuldet uns der Kunde eine Vertragsstrafe von 30 % des Kaufpreises. Ist unser tatsächlicher Schaden höher, können wir diesen geltend machen.

Abbildungen und Beschreibungen in unseren Prospekten, Katalogen oder Preislisten sowie unsere Muster sind für die Ausführung nicht verbindlich. Konstruktionsänderungen, Strukturabweichungen in der Holzmaserung sowie geringfügige Abweichungen im Design und in der Farbe bleiben ausdrücklich vorbehalten.

3. Lieferbedingungen

Die Liefertermine gelten als annähernd, es sei denn, sie werden von uns ausdrücklich als verbindlich bezeichnet.

Die Lieferungen erfolgen ab Werk und ohne Endmontage. Für Transportschäden haften wir nicht. Solche Schäden sind spätestens fünf Tage nach Erhalt der Ware gegenüber dem Frachtführer schriftlich geltend zu machen. Mindermengen sind dem Frachtführer unverzüglich schriftlich mitzuteilen und von diesem schriftlich bestätigen zu lassen.

Wir sind zu Teillieferungen berechtigt, wobei jede Teillieferung gesondert in Rechnung gestellt werden kann.

Die Einhaltung unserer Lieferverpflichtung setzt die rechtzeitige und ordnungsgemässe Erfüllung der Vertragspflichten des Kunden voraus. Dies gilt namentlich im Falle von vereinbarten Anzahlungen oder anderer Vorleistungen. Sollte dies nicht der Fall sein, verlängert sich die Lieferfrist entsprechend und wir sind berechtigt, uns dadurch verursachte Umtriebe und Wartezeiten in Rechnung zu stellen.

Bei Lieferverzögerungen infolge unvorhergesehener Ereignisse wie Streiks, Aussperrungen, Boykotte, verspätete Lieferungen der Unterlieferanten, Lieferverzug durch den Frachtführer sowie höherer Gewalt verlängert sich die Lieferfrist um die Dauer der Wirkung solcher Ereignisse.

Bei Lieferverzug unsererseits hat uns der Kunde eine angemessene Nachfrist zu setzen. Der Kunde hat keinen Anspruch auf Ersatz von direkten oder indirekten Verzugschäden.

4. Übergang von Nutzen und Gefahr

Sofern nicht ausdrücklich etwas anderes schriftlich vereinbart ist, gehen Nutzen und Gefahr mit Abgabe der Lieferung an den Kunden oder an den Frachtführer über.

Wird die Abgabe der Lieferung aus Gründen verzögert, die wir nicht zu vertreten haben, geht die Gefahr im ursprünglichen für die Ablieferung ab Werk vorgesehenen Zeitpunkt über. Von diesem Zeitpunkt an wird die Lieferung auf Rechnung und Gefahr des Kunden durch uns gelagert.

5. Preise

Unsere Preise verstehen sich inklusive Staubschutzverpackung, aber zuzüglich schweizerische Mehrwertsteuer. Ändern sich die Preise zwischen dem Vertragsabschluss und der Lieferung, so gelten die Preise im Zeitpunkt der Bestellung.

6. Zahlungsbedingungen

Unsere Rechnungen sind mit einer Zahlungsfrist von 10/30 Tagen ab Rechnungsdatum zu bezahlen. Ein Skonto oder andere Abzüge sind nur zulässig, wenn sie schriftlich vereinbart worden sind.

Ab Verfalldatum hat der Kunde ohne besondere Mahnung einen Verzugszins von 5 % p.a. zu bezahlen. Der Anspruch auf Ersatz von weiteren Schaden bleibt vorbehalten.

Forderungen dürfen nur zur Verrechnung gebracht werden, wenn diese von uns schriftlich anerkannt oder rechtskräftig gerichtlich festgestellt worden sind.

7. Eigentumsvorbehalt

Die von uns gelieferte Ware bleibt bis zur vollständigen Bezahlung sämtlicher unserer Forderungen aus der Geschäftsverbindung mit dem Kunden unser Eigentum. Wir sind berechtigt, die Eintragung des Eigentumsvorbehalts im amtlichen Register auf Kosten des Kunden vorzunehmen und alle erforderlichen Formalitäten zu erfüllen. Der Kunde hat ferner alle Massnahmen zu treffen, damit unser Eigentumsanspruch nicht beeinträchtigt wird.

Der Kunde hat die erhaltene Ware während der Dauer des Eigentumsvorbehalts auf seine Kosten instand zu halten und gegen Diebstahl, Bruch, Feuer, Wasser und sonstige Risiken zu versichern.

Bei Verbindung mit anderer Ware erwerben wir Miteigentum. Die ganze neue Sache gilt ebenfalls als Vorbehaltsware in Sinne dieser ALB.

Ist der Kunde länger als sieben Tage in Zahlungsverzug oder haben wir berechtigte Zweifel an der Zahlungsfähigkeit des Kunden, sind wir berechtigt, die Vorbehaltsware zurückzunehmen.

8. Gewährleistung und Haftung

Der Kunde hat jeden Mangel schriftlich zu rügen. Erfolgt die Rüge eines offenkundigen Mangels nicht bis spätestens fünf Tage nach dem Erhalt der Ware oder die Rüge eines versteckten Mangels nicht sofort nach dessen Feststellung, so gilt die Rüge als verspätet und allfällige Mängelrechte sind verwirkt.

Die Gewährleistungsfrist für Sachmängel der von uns gelieferten Ware beträgt ein Jahr ab Erhalt der Ware durch den Kunden.

Ist unsere Ware mangelhaft, sind wir berechtigt, entweder den Mangel zu beheben (Nachbesserung) oder die mangelhaften Teile zu ersetzen. Gelingt die Nachbesserung nicht oder nur teilweise oder sind wir nicht in der Lage, die mangelhaften Teile zu ersetzen, kann der Kunde eine angemessene Herabsetzung des Kaufpreises verlangen oder vom Vertrag zurücktreten. Eine Rückerstattung des Kaufpreises kommt nur für die vom Rücktritt betroffenen Teile in Betracht.

Jede weitere Gewährleistung oder Haftung, insbesondere für direkte oder indirekte Schäden, Mangelfolge- und Drittschäden, entgangener Gewinn oder sonstige Vermögensschäden des Kunden, ist – soweit gesetzlich zulässig – ausgeschlossen. Wir haften – soweit gesetzlich zulässig – nicht für allfällige Beratungsmängel.

Werden während der Gewährleistungsdauer ohne unsere Genehmigung Veränderungen oder Reparaturen an der Ware ausgeführt, erlischt unsere Gewährleistungspflicht.

Werden durch Handlungen oder Unterlassungen des Kunden oder seiner Hilfspersonen Personen verletzt oder Sachen Dritter beschädigt, und werden wir dafür in Anspruch genommen, haben wir ein Rückgriffsrecht auf den Kunden.

9. Erfüllungsort, anwendbares Recht, Gerichtsstand

Erfüllungsort ist Baden, Schweiz.

Für Inhalt und Auslegung unserer Angebote, Verträge und dieser ALB gilt das materielle schweizerische Recht. Die Anwendbarkeit des Übereinkommens der Vereinten Nationen über Verträge über den internationalen Warenkauf («Wiener Kaufrecht», CISG) sowie von Kollisionsnormen ist ausgeschlossen.

Gerichtsstand für alle Streitigkeiten aus oder im Zusammenhang mit diesen ALB ist – unter Vorbehalt abweichender zwingender Bestimmungen des Bundesrechts – Baden, Schweiz. Wir behalten uns jedoch vor, auch am Wohnsitz bzw. Sitz des Kunden zu klagen, wobei ausschliesslich schweizerisches Recht anwendbar bleibt.

10. Änderungen

Wir behalten uns die jederzeitige Änderung dieser ALB vor. Diese werden dem Kunden auf geeignete Weise bekannt gegeben und gelten ohne Widerspruch innert Monatsfrist als genehmigt.

1. Domaine d'application

Sauf indication contraire faite par écrit, les présentes conditions générales de livraison (ci-après CGL) s'appliquent à tous les contrats de livraison de marchandises et, par analogie, aux prestations de services effectuées pour nos clients. Par sa commande, le client accepte ces conditions sans restriction. Les présentes CGL ne peuvent être annulées par des CGL divergentes du client, à moins que des dérogations aient été convenues expressément par écrit lors de la conclusion du contrat.

2. Conclusion de contrat

La commande du client représente une offre ferme. Le contrat est considéré comme conclu quand le fournisseur a confirmé la commande par écrit. Les confirmations de commandes doivent être examinées dès réception. Toute objection doit nous être communiquée immédiatement par écrit. D'éventuelles offres de notre part sont sans engagement. Si le client résilie le contrat avant que la marchandise ait été remise au transporteur ou si le client ne respecte pas le contrat, il nous doit une pénalité contractuelle de 30 % du prix d'achat. Si notre dommage réel est plus élevé, nous sommes en droit de le faire valoir. Les représentations graphiques et descriptions contenues dans nos prospectus, catalogues et barèmes des prix ainsi que nos dessins sont sans obligation pour la fabrication. Nous nous réservons expressément le droit de modifications de conception, de divergences de structure dans le fil du bois et de légères divergences de design et de couleur.

3. Modalités de livraison

Les délais de livraison sont sans engagement sauf si nous les déclarons expressément comme étant fermes. Les livraisons se font départ d'usine et sans montage final. Nous ne sommes pas responsables de dommages subis pendant le transport. Ce genre de dommages est à faire valoir par écrit auprès du transporteur au plus tard cinq jours après réception de la marchandise. En cas de marchandises livrées en quantité insuffisante, le transporteur doit être immédiatement informé par écrit et confirmer le manque par écrit. Nous sommes en droit d'effectuer des livraisons partielles, auquel cas chaque livraison partielle peut être facturée séparément. Le respect de notre obligation de livraison présuppose le respect en temps voulu et conforme des obligations contractuelles du client. Cela vaut notamment en cas d'acomptes convenus ou d'autres prestations préalables. Si cela n'est pas le cas, le délai de livraison en est retardé d'autant et nous sommes en droit de facturer les tracas et délais ainsi causés. En cas de retards de livraison dus à des événements imprévus tels que grèves, lockout, boycotts, retards de livraison des sous-traitants, retards de livraison causés par le transporteur ou cas de force majeure, le délai de livraison est prorogé de la durée de l'impact de ces événements. En cas de retard de livraison de notre part, le client doit nous accorder un délai supplémentaire approprié. Le client ne peut prétendre à des dommages et intérêts pour les préjudices résultant directement ou indirectement d'un retard de livraison.

4. Transfert des profits et des risques

Sauf indication contraire faite par écrit, les profits et les risques sont transférés au moment de la prise de livraison par le client ou le transporteur. Si la prise de livraison est retardée pour des raisons qui ne nous incombent pas, les risques sont transférés à la date de livraison départ d'usine initialement prévue. À partir de cette date, nous entreposons la livraison aux risques et périls du client.

5. Prix

Nos prix s'entendent emballage anti-poussière inclus, TVA suisse en sus. Si les prix sont modifiés entre la conclusion du contrat et la livraison, les prix valables à la date de la commande restent en vigueur.

6. Modalités de paiement

Nos factures sont payables dans un délai de 10/30 jours à compter de la date de facturation. Les escomptes ou autres réductions nécessitent un accord écrit. Si le client fait l'objet d'un retard de paiement, il doit payer des intérêts moratoires de 5 % p.a. sans avertissement particulier. Nous nous réservons le droit de réclamer des dommages et intérêts. Le client ne peut prétendre à des droits de compensation que si ses contre-prétentions sont reconnues par nous par écrit ou constatées judiciairement.

7. Réserve de propriété

Nous conservons la propriété de la marchandise jusqu'à réception intégrale de tous les paiements résultant de notre relation commerciale avec le client. Nous sommes en droit de faire inscrire la réserve de propriété au registre public avec la participation du client et de remplir toutes les formalités nécessaires. En outre, le client est tenu de prendre toutes les mesures nécessaires à la protection de la propriété du fournisseur. Pendant la durée de la réserve de propriété, le client est tenu d'entretenir la marchandise reçue et de l'assurer contre le vol, la casse, le feu, l'eau et autres risques. En cas de transformation d'une marchandise avec un autre bien ne nous appartenant pas, nous acquérons le droit de copropriété. Le nouveau bien dans son ensemble est également considéré comme une marchandise réservée aux fins des présentes CGL. Si le client a un retard de paiement de plus de sept jours ou si nous avons des doutes légitimes sur sa solvabilité, nous sommes en droit de reprendre la marchandise réservée.

8. Garantie et responsabilité

Le client doit réclamer tout défaut de la marchandise par écrit. Si le défaut est apparent et qu'il n'est pas réclamé dans les cinq jours suivant la réception de la marchandise; ou si le défaut est caché et qu'il n'est pas réclamé dès sa constatation, la réclamation est considérée comme étant tardive et le client est déchu de tout droit de réclamation du défaut. Le délai de garantie pour les défauts de la marchandise fournie est d'un an à compter de la réception de la marchandise par le client. Si la marchandise est défectueuse, nous sommes en droit soit de la remettre en état (réparation des défauts), soit de remplacer les pièces défectueuses. Si la réparation n'est pas ou seulement en partie satisfaisante, ou si nous ne pouvons pas remplacer les pièces défectueuses, le client se réserve le droit de réclamer une diminution appropriée du prix d'achat ou de résilier le contrat. Un remboursement du prix d'achat n'est envisageable que pour les pièces concernées par la résiliation. Toute autre garantie ou responsabilité est exclue – dans la mesure où la loi le permet –, en particulier pour les dommages directs ou indirects, les dommages consécutifs au défaut, les dommages subis par répercussion, le manque à gagner ou autres préjudices pécuniaires du client. Nous ne pouvons être tenus responsables – dans la mesure où la loi le permet – d'un éventuel manque de consultation. En cas de modifications ou réparations effectuées sur la marchandise sans notre autorisation pendant la période de garantie, notre obligation de garantie expire. Si des personnes sont blessées ou si les biens de tiers sont endommagés à cause d'actes ou d'omissions du client ou de ses auxiliaires, nous ne pouvons être tenus pour responsables et avons droit de recours sur le client.

9. Lieu d'exécution, droit applicable et for

Le lieu d'exécution est Baden, Suisse. Le contenu et l'interprétation de nos offres, contrats et des présentes CGL sont soumis au droit matériel suisse. L'applicabilité de la Convention des Nations Unies sur les Contrats de Vente Internationale de Marchandises («Convention de Vienne», CVIM) ainsi que des règles de conflit sont exclues. Le for compétent pour tout litige en rapport avec les présentes CGL ou en résultant est – sous réserve de dispositions impératives du droit fédéral divergentes – à Baden, Suisse. Nous nous réservons cependant le droit d'intenter une action auprès du tribunal du domicile ou du siège du client, l'unique droit applicable demeurant le droit suisse.

10. Modifications

Nous nous réservons le droit de modifier les présentes CGL à tout moment. Ces dernières sont communiquées au client de manière adéquate et sont considérées comme approuvées si le client ne les conteste pas dans le mois.

1. Area of application

As far as nothing to the contrary has been agreed to, these general terms of delivery apply to all contracts for the delivery of goods and, in the general sense, also for the performance of services vis-à-vis our customers. On placing his order, the customer unreservedly accepts these general terms of delivery.

These general terms of delivery are not cancelled through the customer's contrary general terms and conditions unless deviations have been explicitly agreed to in writing on conclusion of the agreement.

2. Realization of a contract

The customer's order is a binding offer. The contract comes about with the written order confirmation. The order confirmations shall be examined on receipt. We must be notified of any objections in writing immediately. Our offers are subject to confirmation.

In the event the customer withdraws from the contract before the goods have been handed over to the carrier or the customer culpably does not fulfil the agreement, the customer shall pay us a contract penalty in the amount of 30 percent of the purchase price. In the event our actual damage is higher, we are entitled to assert the relevant claim for compensation. Illustrations and descriptions in our brochures, catalogues and price lists as well as our samples are not binding for the execution of the order. Changes to the design, deviations to the structure in the wood grain as well as minor variations in design and the colour remain expressly reserved.

3. Delivery conditions

Delivery dates are considered as approximate unless we have expressly confirmed them as binding.

Deliveries are ex works and without final assembly. We are not liable for transport damage. Any damage shall be asserted against the carrier at the latest five days after the receipt of the goods. The carrier is to be immediately notified in writing of reduced quantities; these reduced quantities must be confirmed by the carrier.

We are entitled to carry out part deliveries whereby each part delivery can be invoiced separately.

Adherence to our commitment to fulfil delivery obligations presupposes the timely and proper fulfilment of the customer's contractual obligations. This applies namely in the instance of agreed prepayments or other advance payments. Should this not apply, the delivery deadline is extended accordingly and we are entitled to invoice any additional expenditure and waiting periods. In the event of a delay in delivery as a result of unforeseen circumstances such as strikes, lockouts, boycotts, late deliveries by sub-contractors, delivery delays by the carrier as well as force majeure, the delivery period is extended by the duration of the effects.

In the event of a delay in delivery from our side the customer shall grant a reasonable extension. The customer is not entitled to any compensation of direct or indirect damage as a result of the delay.

4. Transfer of use and risk

In so far as this is not agreed to in writing elsewhere, use and transfer of risk are passed on to the customer on delivery or on delivery to the carrier.

If the delivery is delayed for reasons for which we are not responsible, the risk is passed on to at the time the goods would have been delivered ex works to the customer as originally envisaged. From this point in time, the delivery is stored with us at the customer's risk and for his account.

5. Prices

Our prices are inclusive of dust protection packaging but exclusive of Swiss VAT. If the prices change takes place between the date of contract conclusion and the delivery date, the price at the time of the order shall apply.

6. Payment terms

Our invoices are due within 10/30 days as from date of invoice. Discount or other deductions are only permissible if they have been agreed to in writing in advance.

As from the due date of the invoice, the customer shall pay 5 percent interest on arbacks without any special reminder being sent. A further claim for damages remains reserved.

Claims may only be set off if we have acknowledged these in writing or they have been determined according to a court of law.

7. Reservation of title

All goods we have delivered remain our property until full settlement of all our claims in terms of the business relationship with the customer. We are entitled to enter the reservation of title in an official register at the customer's expense and to fulfil all required formalities. Further, the customer must carry out all measures to ensure that our reservation of title is not affected.

The customer shall maintain the goods received during the term of the reservation of title at his expense and insure the goods against theft, breakage, fire, water and other risks.

We acquire co-ownership in the event the goods are combined with other goods. The whole new situation also falls under the reservation of title in terms of these general delivery conditions.

We are entitled to take back the goods falling under the reservation of title, should the customer be in arbacks for a period of more than seven days or we have reasonable doubt regarding the customer's solvency.

8. Warranty and liability

The customer shall notify us in writing of any defects to the goods. Should the notification of an obvious defect not take place at the latest five days after receipt of the goods or the notification of a hidden defect not take place as soon as it has been detected, the notification of defects is considered to be delayed and any possible rights arising from product defects are forfeited.

The warranty deadline for defects to goods delivered by us is one year as from the date the customer received the goods. If our goods are defective, we are entitled to either remove the defect (repair) or to replace the defective parts. In the event that the repair is unsuccessful or only successful in part or we are not in a position to replace the defective part(s), the customer can request a reasonable reduction of the purchase price or withdraw from the contract. Reimbursement of the purchase price only applies to the part / those parts affected by the withdrawal.

As far as legally permissible, every additional warranty or liability, in particular for direct or indirect damage, consequently damage as a result of defects and third party damage, loss of income or other economic loss of the customer is excluded. As far as legally permissible, we are not liable for possible failure to administer proper advice.

Our warranty obligation expires in the event that alterations or repairs are carried out to the goods during the warranty period without our approval.

Should through the actions or omissions by the customer or his auxiliary personnel any persons be injured or the property of a third party be damaged and demands made on us, we have the right of recourse towards the customer.

9. Place of performance, applicable law, jurisdiction

Place of performance is Baden, Switzerland.

Substantive Swiss law applies in terms of the content and interpretation of our offers, contracts and these general terms of delivery. The applicability of the UN Convention on the International Sale of Goods (CISG), («Wiener Kaufrecht», CSIG) as well as rules of the conflict of law is excluded.

Place of jurisdiction for all disputes arising out of or in connection with these general terms of delivery – with the reservation of deviating mandatory provisions of Swiss Federal Law – Baden, Switzerland. However we reserve the right to also take legal action at the customer's domicile and/or head office whereby Swiss law shall apply exclusively.

10. Changes

We reserve the right to change these general terms of conditions at any time. The customer will be notified of such changes in a suitable manner. Changes are considered valid unless an objection is received within a month.

Atelier Oi
Jörg Boner
Frédéric Dedelley
Hans Eichenberger
Ginbände – Achim Heine & Uwe Fischer
Matthieu Girel
Alfredo Häberli
Trix & Robert Hausmann
Ubaldo Klug
Masayuki Kurokawa
Gerd Lange
Loris & Livia
Christophe Marchand
Adrian Meyer
Benny Mosimann
Johann Munz
Franz Polzhofer
Ludwig Roner
Heiner Scheppeler
Richard Wassmann
Hannes Wettstein
Marco Zaccheo
Stefan Zwicky

1983

wogg 1
Design:
Gerd Lange

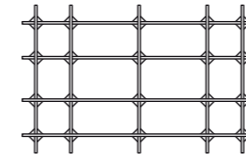

wogg 2
Design:
Wogg



wogg 3
Design:
Ubaldo Klug

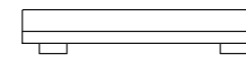

wogg 5
Design:
Ludwig Roner



wogg 7
Design:
Hans Eichenberger



wogg 8
Design:
Hans Eichenberger



wogg 9
Design:
Ludwig Roner

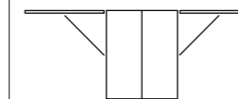

1985

wogg 10
Design:
Gerd Lange

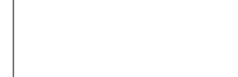

1986

wogg 4
Design:
Heiner Scheppeler



wogg 6
Design:
Ludwig Roner

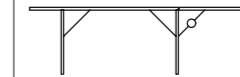

1987

wogg 11
Design:
Masayuki Kurokawa



1988

wogg 12
Design:
Trix & Robert Haussmann



1989

wogg 4*
Design:
Johann Munz / Wogg

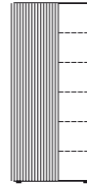

1992

wogg 10*
Design:
Adrian Meyer



wogg 5*
Design:
Stefan Zwicky

1993

wogg 14
Design:
Trix & Robert Haussmann

wogg 3*
Design:
Willi Glaeser

1994

wogg 13
Design:
Hans Eichenberger



1995

wogg 15
Design:
Richard Wassmann

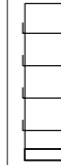

wogg 16
Design:
Uwe Fischer, Achim Heine



1996

wogg 17
Design:
Benny Mosimann



1997

wogg 18
Design:
Benny Mosimann

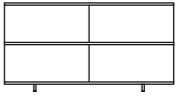

1998

wogg 19
 Design:
 Benny Mosimann

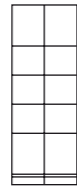

wogg 40
 Design:
 Hannes Wettstein



wogg 22
 Design:
 Wogg

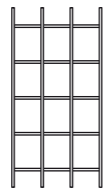

1999

wogg 20
 Design:
 Benny Mosimann



2000

wogg 21
 Design:
 Benny Mosimann

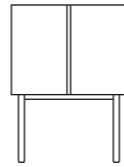

wogg 23
 Design:
 Marco Zaccheo



2001

wogg 24
 Design:
 Atelier Oi

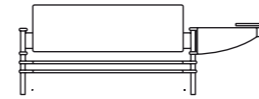

wogg 14*
 Design:
 Wogg



wogg 25
 Design:
 Christophe Marchand



2002

wogg 26
 Design:
 Benny Mosimann



wogg 27
 Design:
 Christophe Marchand



2003

wogg 28
 Design:
 Atelier Oi

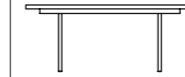

wogg 29
 Design:
 Atelier Oi



2004

wogg 30
 Design:
 Franz Polzhofer



wogg 31
 Design:
 Atelier Oi

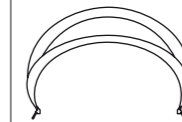

wogg 32
 Design:
 Atelier Oi

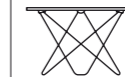

wogg 35
 Design:
 Wogg



2005

wogg 34
 Design:
 Atelier Oi

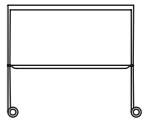

wogg 36
 Design:
 Christophe Marchand



2006

wogg 33
 Design:
 Hannes Wettstein

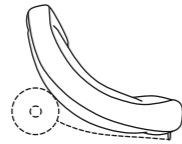

wogg 37
 Design:
 Alfredo Häberli



wogg 38
 Design:
 Alfredo Häberli



wogg 39
 Design:
 Frédéric Dedelley

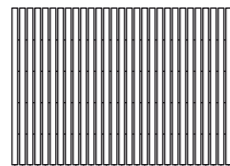

2007

wogg 41
 Design:
 Adrian Meyer

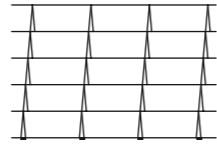

wogg 42
 Design:
 Jörg Boner



wogg 43
 Design:
 Jörg Boner



wogg 44
 Design:
 Benny Mosimann

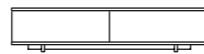

2008

wogg 47
 Design:
 Frédéric Dedelley

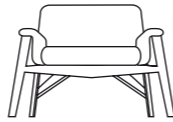

2009

wogg 49
 Design:
 Atelier Oi

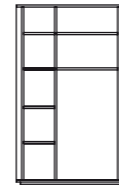

2010

wogg 50
 Design:
 Jörg Boner



wogg 51
 Design:
 Atelier Oi

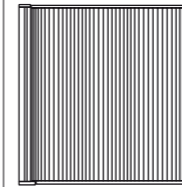

wogg 52
 Design:
 Christophe Marchand

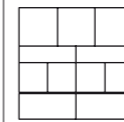

wogg 53
 Design:
 Atelier Oi

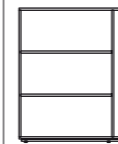

2012

wogg 58
 Design:
 Benny Mosimann

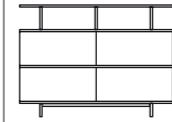

wogg 59
 Design:
 Benny Mosimann



wogg 54
 Design:
 Christophe Marchand

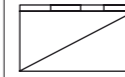

2013

wogg 56
 Design:
 Jörg Boner



2015

wogg 60
 Design:
 Christophe Marchand



2016

wogg 61
 Design:
 Christophe Marchand

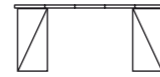

2017

wogg 62
 Design:
 Christophe Marchand

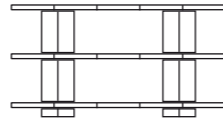

2019

wogg 67
 Design:
 Benny Mosimann



wogg 70
 Design:
 Matthieu Girel

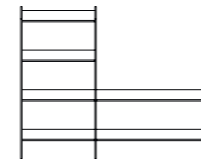

wogg 72
 Design:
 Christophe Marchand



2020

wogg 73
 Design:
 Benny Mosimann



wogg 74
 Design:
 Benny Mosimann

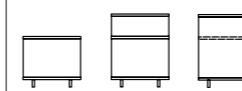

2021

wogg 79
 Design:
 Christophe Marchand

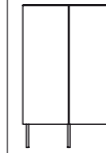

wogg 80
 Design:
 Christophe Marchand



wogg 81
 Design:
 Christophe Marchand

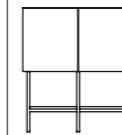

wogg 82
 Design:
 Christophe Marchand



wogg 83
 Design:
 Christophe Marchand

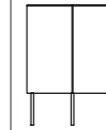

wogg 84
 Design:
 Christophe Marchand

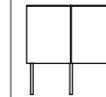

* Zweitbenutzung der
 Wogg-Nummer

Impressum
Impressum
Imprint

Wogg Furniture Ltd.
Willi Glaeser (CEO)
Christophe Marchand (Creative Director)

Im Grund 16
CH-5405 Baden-Dättwil
Switzerland

Art Direktion / Direction artistique / Art direction:
Christophe Marchand

Konzept, Text / Concept, texte / Concept, text:
Stephanie Ringel – www.stephanieringel.com

Grafik / Graphisme / Graphics:
Alena Fabia Schwarz – www.alenafabia.com

Renderings / Rendu 3D / Renderings:
Matthieu Girel – www.matthieugirel.com

Übersetzung / Traduction / Translation:
Franck Hamet (F), Jocelyn Polen (E)

Druck / Impression / Print:
Eichholzer Druck+Kopie AG – www.eichholzerdruck.ch

Schriften / Fontes / Fonts:
Helvetica Neue LT Pro 65 Medium
Helvetica Neue LT Pro 45 Light

Mai 2022
© Wogg Furniture Ltd., Switzerland

Notizen

Notes

Notes

Wogg Furniture Ltd.
Im Grund 16
CH-5405 Baden Dättwil
Switzerland

+41 56 483 37 00
info@wogg.ch

www.wogg.ch

